

How To Compose A PhD Thesis In Music Composition

David Antony Pocknee

A thesis submitted to the University of Huddersfield
in partial fulfilment of the requirements for the
degree of Doctor of Philosophy

September 2017

Correction #3: for UoH

When you submit a PhD thesis to a university, it has to fulfil a set of criteria. At the University of Huddersfield, this information can be found in a document called "Postgraduate Research Degrees: Guidelines for the submission of work for examination" (August 2015), found on the University's internal "Unilearn" computer network. This document states that, for any thesis submitted:

1. Asserts rights of author → The following notes on copyright and the ownership of intellectual property rights must be included as written below:

2. Allows university to do whatever they want with it → i. The author of this thesis (including any appendices and/or schedules to this thesis) owns any copyright in it (the "Copyright") and s/he has given The University of Huddersfield the right to use such Copyright for any administrative, promotional, educational and/or teaching purposes.

3. Only allows copies made according to "regulations of the University Library" → ii. Copies of this thesis, either in full or in extracts, may be made only in accordance with the regulations of the University Library. Details of these regulations may be obtained from the Librarian. This page must form part of any such copies made.

4. Protests 3rd party copyright → iii. The ownership of any patents, designs, trade marks and any and all other intellectual property rights except for the Copyright (the "Intellectual Property Rights") and any reproductions of copyright works, for example graphs and tables ("Reproductions"), which may be described in this thesis, may not be owned by the author and may be owned by third parties. Such Intellectual Property Rights and Reproductions cannot and must not be made available for use without the prior written permission of the owner(s) of the relevant Intellectual Property Rights and/or Reproductions.

What are these?
Why?
Why?

(from pages 5-6)

"But wait!" you, the reader, exclaim "what am I actually allowed to do with this document? Can I make derivatives? Copy it without attribution? What are these 'regulations of the University Library' which would give me the answers? And why do I need to contact a librarian to find out?"

After emailing the University Repository, which stores and controls access to all submitted theses, it turns out that these regulations are found in the document "Repository Policy: E-Theses" (2009) (http://eprints.hud.ac.uk/Thesis_Policy_September_2009.pdf)
This document states that:

Creative Commons Licenses are applied to all deposited theses to specify how others may use the work once they have access to it. The default license assigned to a thesis in the repository is a Creative Commons Attribution-Non-Commercial-No Derivative Works 2.0 UK: England & Wales. This license will be applied unless the author specifies that a different Creative Commons License is to be applied.

So your use of this document is actually under Creative Commons, not traditional copyright, despite how the official copyright statement looks!

Now, when I contacted the Repository, they didn't seem to have a problem with me replacing the official copyright statement with an actual Creative Commons one to make the situation clearer, as this would simply be asserting the rights that will already be applied upon submission. But, of course, they aren't the ones who set the guidelines for thesis submission. As I write this, I'm still waiting for a conclusive response back from the Registry department, who said they "may need a little while to unpick this."

Note: This copyright statement was removed from the official submission. Everything else is as submitted.

So, to hedge my bets, and prevent myself being in a situation where I either endorse a copyright statement that I don't believe in and which confuses authors and readers as to their rights; or ending up having my thesis rejected for breaking the regulations, I've included the original statement but with these annotations.

Additionally, in accordance with the university's "Repository Policy: E-Theses" document, I am specifying that this thesis be distributed under a different Creative Commons License, namely a ...



Creative Commons License Deed

Attribution-NonCommercial-ShareAlike 4.0 International
(CC BY-NC-SA 4.0)

This is a human-readable summary of (and not a substitute for) the license.

You are free to:

Share — copy and redistribute the material in any medium or format

Adapt — remix, transform, and build upon the material

The licensor cannot revoke these freedoms as long as you follow the license terms.

Under the following terms:



Attribution — You must give appropriate credit, provide a link to the license, and indicate if changes were made. You may do so in any reasonable manner, but not in any way that suggests the licensor endorses you or your use.



NonCommercial — You may not use the material for commercial purposes.



ShareAlike — If you remix, transform, or build upon the material, you must distribute your contributions under the same license as the original.

No additional restrictions — You may not apply legal terms or technological measures that legally restrict others from doing anything the license permits.

Notices:

You do not have to comply with the license for elements of the material in the public domain or where your use is permitted by an applicable exception or limitation.

No warranties are given. The license may not give you all of the permissions necessary for your intended use. For example, other rights such as publicity, privacy, or moral rights may limit how you use the material.

By making rights contingent upon an unnamed document, accessible only via librarian, the rights of reader and author are obfuscated. None of the PhD graduates or candidates that I spoke to about this had any idea that the licenses applied to Repository-held theses was Creative Commons. Similarly, for readers, although the Repository website is good at informing downloaders of their rights; as a pdf file on the internet, this thesis might be downloaded without this context, should it find itself elsewhere on the web. But, most importantly, because the rights of author and reader are not made explicit in the text itself and are contingent upon the "regulations of the University Library", it begs the question of "what should happen if the university policy on copyright of theses changes? Do my rights change too?" By making rights explicit in the document itself, I hope to guard against these problems.

I write this not to embarrass the university, but to highlight an approach used in this thesis: do not accept existing categories; everything is up for question; the examined life is not worth living. A thesis is not just a thesis, it is a genre, a historical accretion of rules and regulations. And no rule is ahistorical. And no regulation is non-ideological.

Never do anything just because someone tells you to. Similarly, never refuse to do anything just because someone tells you to. We want neither the hellish bureaucracy of Kafka, nor the ignorant contrivarianism of

Then the servant had to go back to the trolley for more evidence. By now it had run on of its own accord down the slight slope of the corridor, or he had to go after the gentleman who was claiming the files and exchange the protests of the gentleman currently in possession of them for a new set of counter-protests. Such negotiations went on for a very long time, and sometimes it was agreed that the gentleman would give back a part of the files, or would be given a different file in compensation, since they had only been mixed up

The Castle pp 240-241

...the club owner told me - I'll never forget - in Brooklyn - this 10 years - this longer - this 15 years ago - this is when DMX came out - and the owner of the club said "Khaled, do not play no DMX" - I look around, this man must be crazy! I DJ'd the club - first thing I did was play ten DMX's - the biggest fights broke out - it was a riot. I understand why he said it now..."
<https://youtu.be/FDqaen32Di8?t=8m15s>

I'm writing this on 18 September 2017, and, luckily, I seem to have been emailing the university Repository and Registry at a time when they are updating their guidelines and policies on theses and the submission policies, so by the time you're reading this, these policies will probably have changed. But remember that any ruleset is a theoretical readymade waiting to be composed...

~~ABANDON ALL HOPE YE WHO ENTER HERE is scrawled in blood red lettering on the side of the Chemical Bank near the corner of Eleventh and First and is in print large enough to be seen from the backseat of the cab as it lurches forward in the traffic jamming Wall Street and just as Timothy Price...~~

Abstract

I start from the principle that composition is a historical lineage of techniques that have traditionally been applied to music but need not be. To illustrate this, I apply composition principles to the writing of this PhD thesis. In describing this process, I draw parallels between the musical work I have composed during 2013-2017 and the process of thesis writing. Along the way, I show how quantization is not only central to my composition practice but fundamental to the act of composing; I rethink the basic epistemological principles of PhD research, using John Cage's ideology of chance and Arthur Koestler's idea of bisociation; I develop a new set of categories for classifying artworks that use combinatorics, under the umbrella neologism "completism"; expand upon James Tenney's ideas to create a new typology of musical form based on completist principles; and finish by composing the bibliography, font, page-layout, semantics, word choice, and syntax of the Conclusion of this thesis.

Acknowledgements

I would like to thank the Arts and Humanities Research Council for their scholarship, which made this PhD possible; Liza Lim and Aaron Cassidy for supervising me; Beavan Flanagan for his collaboration on developing the concept of completism; my artistic collaborators on the works in the portfolio accompanying this thesis (especially Ana Lemnaru, Grzegorz Marciniak, Angela Guyton, Richard Craig and Leo Svirsky); anyone who has performed any of my works over the last four years (especially Distractfold Ensemble, Inlets Ensemble (Robert Blatt, Jorge Gomez Abrante, Eric Gottlieb, Alex Lough), Michael Baldwin, Andy Ingamells, Winfried Ritsch and his RHEA system, Mira Benjamin, Gregor Riddell, and Kathryn Williams); Robert Adlington for his feedback on this document; Peter Ablinger; and everyone at the University of Huddersfield whose thoughtful discussions have shaped this document in innumerable ways.

This thesis was coded in \LaTeX with TeXstudio, using Jabref for reference management.

Contents

List of Figures	11
List of Tables	15
Introduction	17
1 Quantization	25
1.1 Making Infinity Countable	25
1.2 Optimal and Non-Optimal Quantization	27
1.3 Non-Optimal Musical Quantization	28
1.3.1 Pragmatic Quantization: <i>Almost Every</i>	31
1.3.2 Creative Non-Optimal Quantization	38
1.4 Optimal Notational Quantization	46
1.4.1 Calculating All Possible Optimal Notational Quantizations	49
1.5 <i>Augenmusik V: Blooper Reel</i> and <i>Augenmusik VI: Asch</i>	54
1.6 The Grid and The Choice	60
1.6.1 Quantizing Knowledge	61
Chapter 1 Bibliography	64
2 Divination	71
2.1 In Praise of Love	71
2.2 John Cage at UC Davis	72
2.3 Epistemology	72
2.3.1 Epistemological Constructivism	72
2.3.2 Knowledging	73
2.3.3 Knowledging Through Chance	74
2.3.4 Non-Chance Bisociation	75
2.3.5 Intellectual Singularities and Compactness	76
2.3.6 Normal/Extraordinary Science, Vertical/Lateral Thinking, Arrière/Avant-garde . .	77
2.3.7 Irrationality, Acausality and Epistemological Anarchism	79
2.3.8 Typologies of Thinking	81
2.3.9 The Bisociative/Associative Handshake	82
2.3.10 Music Can Cure Cancer	82
2.4 Hypotheses For An Original Contribution To Knowledge	83
2.5 Types Of Divination	83
2.6 Cage and Quantized Divination (Oionistic/Numerical)	85
2.7 Unquantized Divination (Mantic/Non-numerical)	87
2.7.1 The Psychogeography of Knowledge	87
2.7.2 Reading As Psychogeography and Unquantized Divination	90
2.7.3 Mesostics	90
Chapter 2 Bibliography	97

3	Completism	101
3.1	About Completism	101
3.2	Permutation	103
3.2.1	<i>The Permuted Poems of Brion Gysin</i>	103
3.3	Combination	113
3.3.1	Combination In The Visual Arts	117
3.4	Enumeration	122
3.4.1	Enumeration In Literature	123
3.4.2	Supercuts	124
3.5	Re-Ordering	125
3.6	Mapping	127
3.7	Direct Transcription	131
3.8	Defining Completism	132
3.8.1	The Set	132
3.8.2	The Subsets and/or Their Relations	133
3.8.3	The Ordering	133
3.8.4	The Aesthetic: Almost Solely	135
3.8.5	The Elements of Completism	135
3.9	List Of Completist Works	136
	Chapter 3 Bibliography	140
4	Form	147
4.1	Contemporary Theories of Musical Form	147
4.1.1	Theories of Form and Theories of Genre	148
4.1.2	Overfitting	148
4.1.3	Drawing Inferences from Complex Phenomena	149
4.1.4	Symptoms and Causes	149
4.1.5	My Aims	150
4.2	Typologies of Narrative	150
4.3	A Completist Approach To Structure	157
4.3.1	Synoptic Letter Diagrams	157
4.3.2	The Structural Triangle	164
4.3.3	<i>The Block Structure - Interpolative Structure</i> Pyramid	165
4.4	A Vector-Based Approach to Morphology	167
4.4.1	Calculating Morphological Vectors	168
4.4.2	Morphological Vector Types	169
4.5	State	170
4.5.1	Probability Density Function Rhythm in Feldman's <i>Patterns in a Chromatic Field</i>	170
4.6	Interactions of Shape, State and Structure	177
4.6.1	Shape, Structure and State in Shakespeare's <i>Macbeth</i>	177
4.6.2	Statistical Morphology and Sonata-Allegro Form	180
4.6.3	Wave-Shapes	180
4.6.4	Hybrid Wave-Shapes	183
4.7	Formal Types	185
4.7.1	Linear Form	185
4.7.2	Unity Form	192
4.7.3	Variation Form	192
4.7.4	Loop Form	192
4.7.5	Arch Form	193
4.7.6	Moment Form	193
4.7.7	Formal Types Involving Multi-Hierarchical Relations	194

5	Process	203
5.1	Design	204
5.1.1	Page-Layout	207
5.1.2	Font	210
5.2	Semantics	213
5.2.1	Quantized Divination: Using Random Numbers to Select Books in Huddersfield University Library	213
5.2.2	Unquantized Divination: Dowsing for Journals in Huddersfield University Library	214
5.2.3	Unquantized Divination: Dérive for Journals in Huddersfield University Library . .	215
5.2.4	Information Found	216
5.2.5	The Sortes and Random Quotations from Greek Dramaturgy and Shakespeare . .	217
5.3	Syntax	220
5.3.1	Clauses	220
5.3.2	Words: Tenses of Verbs	227
5.3.3	Words: The Sortes and Random Dictionary Words	228
	Chapter 5 Bibliography	232
	Conclusion: Constraints	234
	Non-Divinatory Bibliography for Chapter 4 and Conclusion	275
	Quantized Divinatory Bibliography for Chapter 4 and Conclusion	279
	Unquantized Divinatory Bibliography for Chapter 4 and Conclusion	281
	Appendix A Optimal Quantization Methods	289
	Appendix B Code For Generating All Possible Structures	295
	Appendix C Completist Structures	299
	Appendix D List of Possible Morphological Vectors	305
	Appendix E Analysis Of Footnote	309

Word Count: 74,065

List of Figures

1	<i>Correction #1 for Jeremiah Runnels (2014)</i>	19
1.1	The four types of continuous and discrete signal types	26
1.2	Example of discrete time discrete amplitude 4bit quantization in an analogue/digital converter	28
1.3	Gradually quantized image. Image taken by Ana Lemnaru	29
1.4	Similar image to Figure 1.3 from Peter Ablinger’s writing about his <i>Quadraturen</i> series (Ablinger 2006).	29
1.5	Sketches from <i>Gruppen</i>	30
1.6	Modified cosine function used for <i>Almost Every</i>	31
1.8	Metric modulation in Elliott Carter’s <i>String Quartet No. 1</i> (Carter 1951)	32
1.9	Extract of <i>Total</i> for two percussionists.	32
1.7	Rhythmic Distortion for <i>Almost Every</i>	32
1.10	Extract of <i>We Doubled Down The Base Camps</i> for violin and cello.	33
1.11	Extract of <i>Almost Every</i> showing chords 5-8 (quantizations of the inter-onset intervals 5767, 4819, 3904 and 3107ms)	33
1.12	The corpus of 17 notes used in <i>Almost Every</i> . Taken from the front page of the score.	34
1.13	Triangle waves used in <i>Almost Every</i>	35
1.14	Alternative	38
1.15	First half of Figure 1.14 quantized into musical notation in <i>Augenmusik I</i>	38
1.16	Tempo cube used for <i>Augenmusik IV: Paperwork</i>	40
1.20	<i>Wedge form</i> used in Harrison Birwistle’s work prior to <i>Melancholia</i>	41
1.17	Piano roll screen in Cubase showing the notes used in <i>Augenmusik IV: Paperwork</i> . The colour of each of the notes shows which pulse stream it is part of in reference to 1.16	42
1.18	Form of <i>Augenmusik IV: Paperwork</i>	43
1.19	Half of section AT and section AU in <i>Augenmusik IV: Paperwork</i>	43
1.21	Extracts from Raymond Queneau’s <i>Exercises In Style</i> (Queneau 1998).	45
1.22	The first few stanzas of Caroline Bergvall’s <i>VIA (36 Dante Translations)</i> (Bergvall 2011, 82)	46
1.23	Optimally quantizing the numbers 0, 1, 4 and 6 with grids of size 1.0, 0.5 and 0.33.	48
1.24	Cello part in bar 883 of Morton Feldman’s <i>Patterns in a Chromatic Field</i> (Feldman 1981)	50
1.25	Extract of the start of the Largo in Movement IV of Beethoven’s <i>Piano Sonata 29 (Hammerklavier)</i>	50
1.26	Page 1 of <i>Augenmusik VII: Our Syntax: x Pulses y Seconds Apart</i> , a work which consists of all possible ways of notating x pulses, y seconds apart, within constraints.	51
1.27	Page 2 of <i>Augenmusik VII: Our Syntax: x Pulses y Seconds Apart</i>	52
1.28	Page 3 of <i>Augenmusik VII: Our Syntax: x Pulses y Seconds Apart</i>	53
1.29	Page 3 of <i>Augenmusik V: Blooper Reel</i>	55
1.30	Page 6 of <i>Augenmusik V: Blooper Reel</i>	55
1.31	Rhythmic Distortion in <i>Augenmusik VI: Asch</i>	56
1.32	Part of the Table of Contents from <i>Linguistics for Dummies</i> (Burton, Déchaine, and Vatikiotis-Bateson 2012, 82)	62
1.33	Hierarchy of Rank from <i>Introducing Language in Use</i> (Merrison et al. 2005, 125)	62
2.1	Three examples of ways of bridging knowledge networks.	77

2.2	Comparing two twitter networks.	78
2.3	Diagrams from the third edition of the Wilhelm/Baynes translation of the <i>I Ching</i> (Wilhelm 1968).	84
2.4	Front cover of my copy of the 2013 edition of Malcolm Gladwell's <i>Tipping Point</i> found during a <i>dérive</i>	87
2.5	Vizualisations of the Wikipedia-Schools entries for philosophy and mathematics (Berthold 2012, 5).	89
2.7	An analysis of the opening few bars of <i>A Beethoven Mesostic</i> showing the original Beethoven sonata from which each fragment is taken from.	92
2.6	An example of one of the mesostics from Cage's <i>Anarchy</i> , spelling out the name of anarchist thinker Peter Kropotkin (Cage 2001).	92
2.8	Image of <i>Selfhelplessness</i>	93
2.9	Image of <i>Selfhelplessness</i>	93
2.10	Diagram showing the structure of <i>Selfhelplessness</i> . The diagram is only partially completed for the sake of clarity.	94
2.11	Image of <i>Selfhelplessness</i>	95
3.1	Graph showing the yearly frequency of completist works in our corpus.	102
3.2	Extract of the first twenty lines of Brion Gysin's <i>I AM THAT I AM</i> (Gysin 2001, 80)	104
3.3	Extract of <i>Overture</i>	105
3.4	Extract of Emmett Williams Cellar <i>Song for Five Voices</i> (1963) from <i>An Anthology Of Chance Operations</i>	106
3.5	Page 1 of <i>Plastic Cup Permutations</i>	107
3.6	Page 2 of <i>Plastic Cup Permutations</i>	108
3.7	Page 3 of <i>Plastic Cup Permutations</i>	109
3.8	Bars 3-18 of Tom Johnson's <i>Tango</i> (1984)	110
3.9	Jackson Mac Low's poem <i>JAIL BREAK</i> (1965) from <i>An Anthology of Concrete Poetry</i> (Williams 2013)	111
3.10	<i>Realization #2: Christian Wolff's "Stones"</i>	112
3.11	Extract from Tom Johnson's <i>The Chord Catalogue</i> (1986)	115
3.12	Screenshot of John Simon's <i>Every Image</i>	116
3.13	Extract from Terence Klex's <i>Some Things We Should Never Speak Of</i> (2015)	116
3.14	Picture of <i>Cipher for the Lighthouse Twins</i>	117
3.15	John Hilliard <i>Camera Recording its Own Condition (7 Apertures, 10 Speeds, 2 Mirrors)</i> (1971)	118
3.16	Image of Sol LeWitt's <i>Incomplete Open Cubes</i> (1974)	119
3.17	Image of etching made as part of Manfred Mohr's <i>Cubic Limit Series</i> (1974)	120
3.18	Extract from bar 25-39 of Act 1 Scene 1 of Eric Carlson's <i>At C: Every Middle C from Tristan und Isolde</i> (2015)	123
3.20	Extract of Eric Carlson's <i>Alphabetized Winterreise</i> (2013) http://midnightsledding.com/carlson/AlphaWinter.pdf	126
3.19	Emmett Williams' <i>abeeüllmmstwy</i> (1966) from <i>Manifestos</i> (2004, p. 30)	126
3.21	Poem	127
3.22	Extract from Luiz Henrique Yudo's <i>On Words: J</i> , arranged by Sergei Zagny (2012)	128
3.23	Extract from Marcel Broodthaers's <i>Un Coup de dés jamais n'abilora le hasard</i>	128
3.25	Two scores from Yoko Ono's <i>Grapefruit</i> (1964).	129
3.24	Extract from Rama Gottfried's <i>Langenscheidt Euro-Edition Teil A</i> (2009)	129
3.26	Extract from <i>NFO: One-Word Fluxus Text Scores</i> running in <i>Firefox</i>	130
3.27	The score of <i>Correction #2</i>	134
4.1	Graph showing the word count for each chapter in this thesis.	147
4.2	McKee's <i>Archplot - Miniplot - Antiplot</i> triangle.	151
4.3	Illustration of the recursive nature of the Shape/Structure/State construction, from <i>META Meta + Hodos</i> (Tenney 2015, 172).	154
4.4	A diagram showing James Tenney's conception of form, which I created from his writings in <i>Meta + Hodos</i> and <i>Form in 20th Century Music</i>	155

4.5	Analysis of nightingale song, showing structural divisions.	158
4.6	Husserl's diagram showing the progression of memory from <i>A Phenomenology of the Consciousness of Time</i> (Husserl 1999), adapted by Deleuze and Guattari in (Deleuze and Guattari 2004, 605).	160
4.7	An enumeration of all possible structures up to 5 sections and 5 material types.	163
4.8	The Structural Triangle (not to scale).	164
4.9	The Structural Pyramid (left) and a cross-section of the Structural Pyramid at the 3-section level.	166
4.10	The Parsons code for <i>Happy Birthday</i> (Rudder 2014, 262)	167
4.11	An example of the way in which a morphological vector is calculated.	168
4.12	First page of Morton Feldman's <i>Patterns in a Chromatic Field</i>	171
4.13	Chart showing the usage of the piano keyboard over the course of all 32 of Beethoven's keyboard sonatas	172
4.14	Diagram showing how a probability density function can describe the deviations from a fixed pulse in rhythmic playing (Hennig et al. 2011).	173
4.15	Rhythmic reduction of the piano part of the first page of Morton Feldman's <i>Patterns in a Chromatic Field</i>	173
4.16	Probability Density Functions for all 3 events in the piano part of the first page of Feldman's <i>Patterns In A Chromatic Field</i>	174
4.17	Piano part created using using PDF Rhythmic approach.	176
4.18	Diagram showing the interactions between shape, structure and state between one hierarchical level and the level directly above.	177
4.19	Diagram showing the interactions between shape, structure and state between one hierarchical level and the level directly above.	178
4.20	Sentiment analysis of Macbeth, adapted from http://hedonometer.org/books/v1/?book=Macbeth&lens=[3.25,7.25]	179
4.21	Figure from (Reagan et al. 2016)	181
4.22	Diagram showing the components of waves (Giancoli 1980, 288).	182
4.23	Example of how frequency and amplitude combine to create formal shapes.	182
4.24	Possible hybrid formal vectors created through the addition or multiplication of two wave-shapes.	184
4.26	My new version of Tenney's conception of form	186
4.27	James Tenney's <i>Koan</i>	187
4.28	Score of <i>The Descent</i>	188
4.29	Score of <i>It's A Diagram If You Believe It, A Relic If Not</i>	189
4.30	Extract from the score of Seth Kim-Cohen's <i>Forever Got Shorter (from a tshirt of the same name)</i> (Kim-Cohen 2010, 1)	190
4.31	Set up for <i>Conditioned</i> for the "subject" being conditioned (photo by Ana Lemnar).	190
4.32	Diagrammatic representation of pitch movement in György Ligeti's <i>Continuum</i> for solo harpsichord (from (McKean 2011, 3))	191
4.33	Diagram showing wedge form in <i>But I Guess, In The End, We Just Moved Furniture Around</i> for solo flute.	191
4.34	<i>Pendulum Music</i> and damped harmonic motion.	192
4.36	Score for LaMonte Young's <i>Composition 1960 #7</i> (from (Lely and Saunders 2008, 425))	192
4.35	The piece <i>Funnel</i> (2017).	193
4.39	Score of James Tenney's <i>Having Never Written A Note For Percussion</i> (Tenney 1984, 203)	193
4.37	Score for Richard Glover's <i>Seventh Inversions</i> (Glover 2010)	194
4.38	Instructions from the score of Erik Satie's <i>Vexations</i>	194
4.40	Compositional sketches for Xenakis's arborescent piece <i>Erikthos</i> from (Matossian 1986, 237)	195
4.41	An analysis of focal pitches in Giacinto Scelsi's <i>Quartetto No 4</i> (Pocknee 2009)	195
4.42	Example of a fractal melody from (Johnson 1996, 146): "The sequence is self-similar at the ratio of 4:1 and ar 16:1, and you can read an inversion of it if you look at every second note or every eighth note, and it behaves like a single repeated procedure, even though it is a hybrid that alternates between two transformation rules."	196
4.43	Instructions from <i>Chronotopes</i>	197

4.44	Instructions from <i>Chronotopes</i>	198
4.45	The flute part from a version of <i>Chronotopes</i>	199
4.46	Page 1 of <i>Gray Winter Grimes</i> (the full gray code can be seen above the title).	200
4.47	Page 2 of <i>Gray Winter Grimes</i>	201
5.1	(Perec 1999, 11)	204
5.2	Extract from Raymond Federman’s <i>Double or Nothing</i> (from (Wielgosz 1995))	205
5.3	Typography in Stockhausen’s <i>Aus Den Sieben Tagen</i> , from (Bandur 2001, 45)	206
5.5	A T-shirt, entitled <i>Thesis 5x5</i> , designed using the same algorithm used for page layout in this thesis.	207
5.4	Components of the page-layout.	207
5.6	The 36 possible page-layouts when the page is divided into 3 sections placed into an order such that there is minimal change between the size and position of each page-layout.	209
5.7	Typeface design by Knuth and Cage.	211
5.8	Start of the two metafont files open in the program Sublime Text. The file on the left is the <i>roman</i> version of <i>Computer Modern</i> , the file on the right is the <i>sans serif</i> version.	212
5.9	The 13 fonts used in the Conclusion. The top and bottom fonts are the <i>roman</i> and <i>sans serif</i> versions of the <i>Computer Modern font</i>	212
5.10	The author dowsing for knowledge in the University of Huddersfield Library (photo by Linda Jankowska).	215
5.11	Video stills from a recording of <i>Some Short Pieces for Robert Blatt</i> (2016) https://vimeo.com/167038294	216
5.12	Chart showing the way in which ideas for Chapter 4 and the conclusion were generated.	218
5.13	A parse tree from <i>Introducing Language In Use</i> (Merrison et al. 2005, 161) in which the clause structure of dialogue from an episode of the television show <i>Yes Minister</i> is analyzed.	221
5.14	A recursive nesting of triplets.	221
5.17	Example of one of Ferneyhough’s characteristic processes used to compose tuplets (Ferneyhough 1995, 55).	222
5.15	Table exhausting all possibilities of different phrase structures at 0 levels of recursion.	223
5.16	Music/parse-tree analysis from (Rohrmeier et al. 2015, 5)	224
5.18	Analysis of clause and sentence lengths	226
5.19	Diagram by the author, showing the construction of Verb Groups	229
A.1	Simple metric optimal quantization of three pulses one second apart using a 60bpm tempo	289
A.2	All possible optimal quantizations of three pulses one second apart, using rational metres lying between 30 - 150 bpm	290
A.3	All possible optimal quantizations of three pulses one second apart, using irrational metres lying between 30 - 150 bpm	290
A.4	Optimal quantization of three pulses one second apart where $TS_d = 16$, $l = 0.75$ and $m = 4$	291
A.5	Optimal quantization by metre of three pulses one second apart.	292
A.6	Result of quantization procedure.	293
A.7	Result of quantization procedure.	294
E.1	Analysis of footnote from the first page of Chapter 1 split into component parts indicated by the numbered red boxes.	310
E.2	Analysis of footnote from the first page of Chapter 1.	311
E.3	Analysis of footnote from the first page of Chapter 1.	312
E.4	Analysis of footnote from the first page of Chapter 1.	313
E.5	Analysis of footnote from the first page of Chapter 1.	314
E.6	Analysis of footnote from the first page of Chapter 1.	315
E.7	Analysis of footnote from the first page of Chapter 1	316
E.8	Analysis of footnote from the first page of Chapter 1	317

List of Tables

1	Pieces and their media	20
1.1	Table showing the tempi used in Stockhausen’s <i>Gruppen</i> along with the values they would be (according to Stockhausen’s article ... <i>How Time Passes ...</i> (Stockhausen 1959)) if the score did not round them to the closest half an integer. From (Pocknee 2012b, 40).	30
1.2	Relationships between metre, tuplet and rhythm, illustrated using four notations of three pulses one second apart.	49
1.3	Timings of onsets of chords played by pianist and player-piano in a recording of the first performance of <i>Augenmusik VI: Asch</i>	57
2.1	Different types of knowledging	81
4.1	Table comparing temporal scales in the writings of Curtis Roads, James Tenney and Robert McKee	153
4.2	Table showing relationship between material types, sections, and structure	161
4.3	Table showing historical forms and their morphological vectors	169
4.4	Table showing the timings of the original work and the random sampling used to create Figure 4.17.	175
4.5	Typology of story types based on Kurt Vonnegut’s rejected masters thesis (Reagan et al. 2016, 6) with corresponding structures and morphologies.	181
5.1	Types of forms used in works in my PhD portfolio.	209
5.2	Table showing the gender of authors in Figure 5.12.	217
5.3	Process used in Figure 5.17.	222
5.4	The number of clause components used in clauses in the Conclusion. These clause components are the ones seen in Appendix E. Notice how the clauses with the largest number of components (in bold) are reduced each section.	228
5.5	A list of possible tenses	230
D.1	All possible morphological vectors with 1 or 2 sections.	305
D.2	All possible morphological vectors with 3 sections.	305
D.3	All possible morphological vectors with 4 sections.	306

Introduction

To prevent from fainting, keep repeating to yourself "it's only a movie, it's only a movie..."

The quotation above was the tagline for Wes Craven's violent 1972 revenge film *The Last House On The Left* (Schneider 2003, 86). I suggest you do something similar when reading this thesis.

So, when the processually-driven extremes of language or typography in this document threaten legibility or sense, just keep repeating to yourself "it's only a music composition PhD, it's only a music composition PhD...".

Whilst on first flip-through it may appear as if parts of this thesis are filled with a gratuitous amount of gimmicks in layout and linguistics, the aim of every facet of this document is to illuminate parts of my working process and approach to art-making in a way that would be difficult to achieve with words alone. This thesis is conceptualised as a composition and a work of art.

This document's Conclusion is *composed* at multiple levels, from font to syntax. The rest of this document is the preparation for this moment, and this introduction is the preparation for the rest of this document.

There are two main challenges in discussing my work:

1. I make a lot of it.
2. The things I make are very different from each other in style, medium, and genre.

This makes drawing easy connections between my disparate output extremely difficult. However, style, medium and genre are not the only things that can connect a set of works.

I am very fond of the opening of Jacques Attali's *Noise* (1985), the piece of writing where I first came across what I fondly refer to as the *Attali Gambit* - not that this is the first work that attempts this, but that it was the first work in which I became aware of this technique as a rhetorical tool. On the second page of the book, Attali claims, without any attribution or discussion, that "music will be presented as originating in ritual murder, of which it is a simulacrum" (Attali 1985, 4)¹. What struck me about this opening is that it puts forward a bold and controversial idea as if it was fact, what Bruno Latour refers to as a *positive modality*:

We will call **positive modalities** those sentences that lead a statement away from its conditions of production, making it solid enough to render some other consequences necessary. We will call **negative modalities** those sentences that lead a statement in the other direction towards its conditions of production and that explain in detail why it is solid or weak instead of using it to render some other consequences more necessary.
(Latour 1988, 23).

¹Although it is not acknowledged, this idea seems taken from René Girard's writings on the symbology of violence (Fleming 2004).

The prominent position of Attali's statement at the start of the work almost goads the reader to disagree, yet also tacitly says "this is a key idea that underpins the thinking of this work and you either accept it as fact now, or put the book down and don't bother reading further".

Here, I think it would be useful to define my own First Principles in a similar way. These ideas are the basis of my work, its "truths", no matter how absurd you may find them:

1. I am a composer.
2. "Composition" is a set of techniques derived from a historical lineage involving the use of sound, but which can be applied to materials other than those which sound.
3. It is possible to compose the entirety of reality.
4. When I am able to compose the entirety of my reality, there will be no reason for me to make music.
5. A PhD thesis should be as creative as the work it discusses.

Adam Harper's 2011 book *Infinite Music* describes an approach to music-making which has many parallels with my own methods of composing. Probably the most important of his ideas is *n-dimensional modernism*, outlined in a passage that is worth quoting at length:

The greatest problem with serialism, though, was in its boiling down of all the complexity of music to one single, simple and absolute system of variables to be serialised, up to four in number: pitch, timbre, duration and volume ... music was nominally a construction of four variables and thus composition amounted to a sculpture in a space of four dimensions ... So, where do we draw a line around which musical variables composers should observe and potentially serialise?

We don't. That was the old serialism, the old modernism. There can be no one absolute foundation for music. And there can be no prior assumptions, no prior techniques and conventions - no restrictions whatsoever. We can't even assume any ultimate distinction between musical activity and the wider lives of ourselves and the universe. That's what the meaning of musical infinity is, and it's in that direction that any future modernist endeavour must travel. Infinite music necessitates an *n-dimensional modernism*.

(Harper 2011, p. 4-5)

Harper describes an approach in which composition in the modernist tradition is no longer bounded by the limits of music, but spews infinitely out to encompass the world around us - the possibility to compose the entirety of reality.

The works submitted in the portfolio as part of this PhD, and those mentioned in this document but not submitted, come in a wide variety of media (see Table 1). They also encompass a number of different styles, even between works in the same medium (compare the Bryn Harrison-ish gestural language of *Augenmusik V: Bloopers Reel* with the Chopin-esque *Augenmusik VI: Asch*, both for solo piano).

The stylistic disparity and differences in medium may almost give the impression that these works were written by different people.

In the philosophy of personality the philosopher David Lewis puts forward a thought experiment based on the biblical figure of Methuselah:

Correction #1
for Jeremiah

31

SOLO FOR VOICE 8
(0'0'')

THEATRE USING ELECTRONICS

(IRRELEVANT)

DIRECTIONS

In a situation ~~perform a disciplined action.~~ perform a disciplined action.

With any interruptions.
Fulfilling in whole or part an obligation to others.
No attention to be given the situation (electronic, musical, theatrical).

dp
12/9/14

- Robert Ashley:* It seems to me that your influence on contemporary music, on "musicians," is such that the entire metaphor of music could change to such an extent that—time being uppermost as a definition of music—the ultimate result would be a music that wouldn't necessarily involve anything but the presence of people. That is, it seems to me that the most radical redefinition of music that I could think of would be one that defines "music" without reference to sound.
- JC: Oh yes, I made some use of that in my silent piece [Ed. Note: Mr. Cage has written a piece (4'33") which directs the performer (if he is a pianist) to come on stage, seat himself at a piano for a specified time without engaging in any other activity than the delineation, by some means, of the 3 movements of the composition. At the end of the designated time, the performer rises and leaves the room without having made any intentional sounds.]
- RA: It doesn't strike me as being that.
- JC: But that involves a number of people being together, and there are no special sounds.
- RA: If our awareness of time increased to such a degree that it didn't require that we be informed of time through the medium of sound—if our awareness of time became enlarged or changed to a really radical degree—then it's conceivable that we would do away with sound.
- JC: But we can't. You see there are always sounds. [8]
- RR: This has to do with the distinction that Mr. Cage has made between sound and silence: that the former consists of sounds that are intended, while the latter allows the sound which occurs unbidden in the environment to be heard.
- JC: Yes.

Interview
with Roger Reynolds

- RR: So that what you are saying, in essence, is that we might do away with intended sounds.
- RA: Well . . . Let me put it this way. We might have a piece from which one participant would come, and, upon being questioned, would say that the occasion was marked by certain sounds. Another person might say that he didn't remember any sounds. There was something else. But they both would agree that a performance of music had taken place.
- RR: This seems to have more to do with what we've discussed as theater.
- RA: It seems that the use of "theater" in this connection is a sort of transitional definition, to condition people to other possibilities.
- JC: And that the experience itself becomes markedly more subjective.
- RA: Markedly more subjective and particularly involved with a sort of indefinable sense of where your time information was coming from.
- JC: Exactly.

* Mr. Ashley, a composer living in Ann Arbor, is one of the organizers of the ONCE activities. He was enjoying the interview, which took place in his living room, and asked if he might comment on this point.

Figure 1: Correction #1 for Jeremiah Runnels (2014)

Medium	Portfolio Pieces	Thesis Pieces (Whole)	Thesis Pieces (Extract)
Small ensemble	<i>Augenmusik IV: Paper Work, We Doubled Down The Base Camps,</i>	<i>Economics (2017 Version)</i> (Fig. C.4), <i>It's A Diagram If You Believe It, A Relic If Not</i> (Fig. 4.29) <i>Funnel</i> (Fig. 4.35)	<i>Total</i> (Fig. 1.9), <i>Some Things We Should Never Talk About</i> (Fig. 3.13), <i>Chronotopes</i> (Fig. 4.43),
Solo performer	<i>Augenmusik V: Blooper Reel, Almost Every, A Beethoven Mesostic</i>	<i>Plastic Cup Permutations</i> (Fig. 3.5), <i>Realization #2: Christian Wolff's "Stones"</i> (Fig. 3.10), <i>Our Syntax: x pulses in y seconds</i> (Fig. 1.26), <i>The Descent</i> (Fig. 4.28), <i>Gray Winter Grimes</i> (Fig. 4.46)	<i>Some Short Pieces for Robert Blatt</i> (Fig. 5.11)
Book	<i>Self-Helplessness, Cipher For The Lighthouse Twins</i>	<i>Thesis</i>	
Net art	<i>Self-Helplessness (online version)</i>		<i>NFO: Book Of Fluxus-Style One-Word Verb Pieces</i> (Fig. 3.26)
Site-specific installation	<i>Digging Piece</i>		
Video-installation	<i>But I Guess, In The End, We Just Moved Furniture Around</i>		
Collage		<i>Correction #1</i> (Fig. 1), <i>Correction #2</i> (Fig. 3.27)	
Audio Recording	<i>MG3250 Performs Cornelis Cardew's "Treatise"</i>		
Player-piano and video	<i>The Chord Catalogue (Redux)</i>		
Piano and player-piano	<i>Augenmusik VI: Asch</i>		
T-Shirt			<i>Thesis 5x5</i> (Fig. 5.5)

Table 1: Pieces and their media

Methuselah aged 900, shares none of the ambitions or interests of Methuselah aged 24, has no memories at all of his activities and none of his character traits. Of course, one may not wish to accept that this is a case in which personal identity is anywhere indeterminate, for one may wish to say that, in virtue of the physical and psychological *continuity* which links these two stages of his life, Methuselah aged 900 *is* (determinately) the same person as Methuselah aged 24.
(Noonan 1991, 131)

Here these two temporal instances of a person's self are considered part of a singular personality, despite their qualitative differences, simply due to the fact they form two points of a psychologically and physically continuous entity. Similarly, I would argue that, given this argument can be applied to something as complex and multifaceted as the nature of our personality, this logic could extend to the more trivial aspects of artistic creation and its relation to the individual that created it. So, when I answer the question: *What is the thing that connects all my works?* with: *I made them*, this isn't just a glib and dismissive response, but an acknowledgement that despite my creative output's stylistic, generic and media disparity, it is implicitly connected in ways that are no more contingent than the unstable foundations of our ontology of self.

Harper's concept of n-dimensional modernism encourages the extension of the modernist project to encompass all facets of existence. The reason that Harper identifies modernism as being most suitable for the "infinite music" he conceives of is due to the flexibility of its compositional systems to deal with material types not exclusively sonic.

I have begun to think that a good comparison for my attitude towards my works is with that of a product designer.

A product designer may be responsible for the design of multiple products, and each of these products may look very different from each other. The company Dyson are famous for their designs of a vacuum and a hand dryer. Whilst these products have some minor aesthetic similarities in colour choices and type of coating material, they are of vastly different shapes and sizes. These differences are a result of the fact that each is designed to serve a different function, and that differences in function define the overall look of the object.

The form of a product has to provide for the technical function, and should also be well thought out in an ergonomic sense. In addition, the form has two other important functions: a semantic and an aesthetic function. The form semantics informs the observer of the meaning of the product: to which group of products does it belong, what it is intended for, and how should it be used? If we give a coffee-pot the form of a tureen[,] confusion is created ... The semantic function is strongly determined by convention, fashion and culture.

(Roozenburg and Ekels 1995, 256)

In the case of the Dyson examples, each product is the answer to a question: "how do you make a more efficient vacuum cleaner?" or "how do you make a more efficient hand dryer?". The similarity of the products to each other is proportional to the similarity of the questions asked of each one.

The design process normally begins with developing a statement or definition of the problem. An essential part of any problem statement is the goal that one wants to achieve. Goals are broad statement of intent, that have to be elaborated into more specific objectives, to be useful for decision making in design. The list of objectives, stemming from different stakeholders in, and affected by the design project, is called the 'design specification'.

(Roozenburg and Ekels 1995, 131)

Similarly, each of my works attempts to be the answer to a question (has a different design specification). Each of these questions/specifications are different, and thus each of the results are different. The question I asked that resulted in the book *Self-Helplessness* ("how do you compose the way in which

somebody reads?") and the question that I asked that led to *Augenmusik IV: Paper Work* ("can you create musical development solely through the rhythmic re-gridding of a never-heard piece of musical material?") necessitated vastly different answers/products/art.²

In my work, style or medium is not a goal, but a subsidiary result of the questions I want to ask in a piece (the form semantics necessitated by the product specification). The real connections between the works are not in what the work sounds or looks like, but in the similarities between the questions asked and the methods used to answer them.

If; My approach is determined by neither medium, style, or genre
And; n-dimensional modernist composition techniques can be used for arranging non-sonic things

Then: This PhD thesis can be a composition.
And: This PhD thesis can be a work of n-dimensional modernism.

If; the real similarities between the works I make is the way in which they are made

Then: What better way of illustrating my composition process than by composing this PhD Thesis and explaining step-by-step how it is put together?

If; all of my work starts from asking a simple question and trying to create a work which can serve as an answer.

Then: Let me ask a simple question which can drive this composition:

How do you compose a PhD thesis in music composition?

²New Testament scholars studying the apostle Paul invariably face the problem of locating a coherent center in his writing and thinking (Meyer 1997; Achtemeier 1996; Hübner 1987; Beker 1980, 11– 19). What prompted Paul to write accounts in part for this problem, for his letters were occasional in nature, sent to particular communities, and typically dealt with multiple, often unrelated, crises. Thus, their content depended to a great degree on the problems or issues troubling the communities Paul addressed. Even his letter to the Romans, which scholars judge the least occasional, does not constitute an organized or exhaustive presentation of his thought." (DeMaris 2007, 39)

Introduction Bibliography

- Attali, Jacques. 1985. *Noise: The Political Economy Of Music*. Manchester, UK: Manchester University Press.
- DeMaris, Richard E. 2007. "Contrition and Correction or Elimination and Purification in 1 Corinthians 5?" In *Social Sciences and Biblical Translation*, ed. by Dietmar Neufeld, 39–50. Atlanta: Society of Biblical Literature.
- Fleming, Chris. 2004. *René Girard: Violence and Mimesis*. Cambridge: Polity.
- Harper, Adam. 2011. *Infinite Music*. Winchester, UK, Washington USA: Zero Books.
- Latour, Bruno. 1988. *Science In Action*. Cambridge, Mass.: Harvard University Press.
- Noonan, Harold. 1991. *Personal Identity*. London: Routledge.
- Roozenburg, N.F. M., and J. Ekels. 1995. *Product Design: Fundamentals and Methods*. New York: John Wiley & Sons.
- Schneider, Steven Jay. 2003. "The Legacy of Last House on the Left." In *Horror at the Drive-In: Essays In Popular Americana*, ed. by Gary D. Rhodes, 79–96. Jefferson, NC / London, UK: McFarland & Company Inc,

*What heaps of things have bitten me to the heart!
A small few pleased me, very few, just four;
But those that vexed were sand-dune hundredfold*

ARISTOPHANES *THE ACHARNIANS*

Chapter 1

Quantization

*"...midnight chaos eternity chaos morning chaos eternity chaos noon chaos eternity
chaos evening chaos eternity chaos midnight..."*
- Julien Donkey-Boy (Korine 1999)

1.1 Making Infinity Countable

A PhD Thesis in a creative discipline is just a story we tell ourselves; it is an excuse for creative myth-making and a description not of how the world is, but how it could be, if only it were more interesting. So I'm going to lie to you now, spin you a creative fiction, in the hope that my lies fascinate more than the dull, prosaic necessity of my actual creative practice. In movies, the Creative will have their "Eureka" moment of divine inspiration¹², but reality is simply the slack-jawed dead-eyed staring at the sky-tinged glow of a computer screen. For hours. As a problem erodes as slow and impassive as geology.³

So, I'm going to tell you four stories about my creative process now, one in each chapter. Paddison talks of the constellation-like nature of Adorno's thought that orbits around a never-stated centre (Paddison 1997), and maybe each of these stories can act like those ancient beacons studded like rivets in the black cloth of the empty abyss that steered scrubbed decks and scurried crew to land, though I know not where. Triangulate me.⁴

You find yourself in the snow, triplewrapped, with it still sludged underfoot and confetti-ing little-bombs, waterfilled and splitting. You stand pen-pawed, it awkwardly viced in your thick glove. You

¹WILL GRAHAM: [watching the Leeds and Jacobi films side by side] And you know you needed a bolt-cutter and every other Goddamn thing... Because everything with you is seeing, isn't it? Your primary sensory intake that makes your dream live is seeing... Reflections... Mirrors... Images... [stunned realization] You've seen these films! Haven't you, my man?" *Manhunter* (Mann 1986) (see also (Mokoena 2014))

²...and that Eureka moment hits you like a cop ca-ar!" *Cough Cough Everything Everything* (Everything 2012)

³And perhaps you ask of the why? of why I make things, as if "for shits and giggles" isn't a "real" enough answer, and eventually, digging down to find only the armchair-psychoanalytic of childhood carjourneys airless overhot and shoulder-crammed with *Ghostbusters* notebook, smudging facepressed windoward, obsessively scribbling every passingcar number-plate, or somesuch nonsense that reduces dimensionality of character down to the cardboardcut-out of the Hollywoodvillain. But know that easyanswers are like watching the river in Bath and seeing the cold water its suspicious blue as if coloured for show - as if that Carribean hue could be found here! more like the blue of Lenor, that tint of endlesschemicals, not like the churling brown of the Thames or the tepid shitsmear of the Witham, or the placid sky-reflecting grey of the Trent as it moves with surface as flat as the endless fens it drains from, the Fosdyke as its Cliff Notes, its annotations - Pound-like running parallel, both bleeding out past the tollbridges seaward through the grass in strands of shreddedsky stretched like an illfittingwig over its banks - a grass that was never truly green but of a colour that seeps out from a histogram smashed as low and featureless as its horizon, in which fish could only weep; a landscape which hates itself and its boredom and your lack of interest and its father and its Dutchness and its low-sky parochialism - its whiteness as if you never moved but you did - and still here on deathwoven roads, hamletted, by pubnames everphotocopied to blackstreaks swinging against that greyagain (everpresent) something for your files, maybe? a crippled bio?

⁴Adorno argues that in order to bring out the dual character of the concepts he is using - that is, their mediatedness - he cannot resort to the traditional structure of discursive logical argument. This is because, he implies, traditional forms of theory work against the contradictory character of the concepts themselves and serve to betray the uniqueness of the 'concrete object' of cognition by subsuming it completely under abstract categories. In place of traditional logic Adorno puts forward an alternative logical structure: that of the 'constellation'."(Paddison 1997, 36)

clipboard-hunch by a red vein of mercury, glasswrapped and mounted and, as that blood slowly falls past the track-marks equally spaced and scored into the darkwood, you write down the figures in celsius every minute, on the minute. This is quantization, the process of making infinity countable.⁵

The infinity of time is portioned off into the neat packets of minutes, marking your inscriptions - this makes its endless flow bearable⁶ - and the continuous movement of the mercury up and down its tube is gridded into discrete markers indicating the centigrade scale. These grids (clock-time and celsius) allow you to understand the world around you. Continuous time becomes discrete time and continuous amplitude becomes discrete amplitude.⁷

You find yourself in a room, paddedwalled, but only to keep out the insanity of outside and its endless sound. Over the course of three seconds there is a set of three pulses one second apart and each lasting one second. You hear them, and though you cannot see, you know that each pulse compresses and rarefies the air around it and that this air between you and the sound source carries the pulses Hermes-quick to the Olympus of your ears. It's no Abbey Road, but the simple room you are in holds a microphone connected to a computer, which records the sound of the three pulses. You know that as the air moved by the pulses compresses and rarefies, it forces the diaphragm of the microphone back and forth in a continuous motion. But the Pentium beast ingests only solid food! You know of the limits of von Neuman architecture that structures the inside of that calculating machine, those 1s and 0s flipping like insectwings, and the impossibility of anything else, no 0.5, no 0.23, no 0.5772156649... and know that the movement of that diaphragm must be gridded to be ingested. This is quantization, the process of making infinity countable.

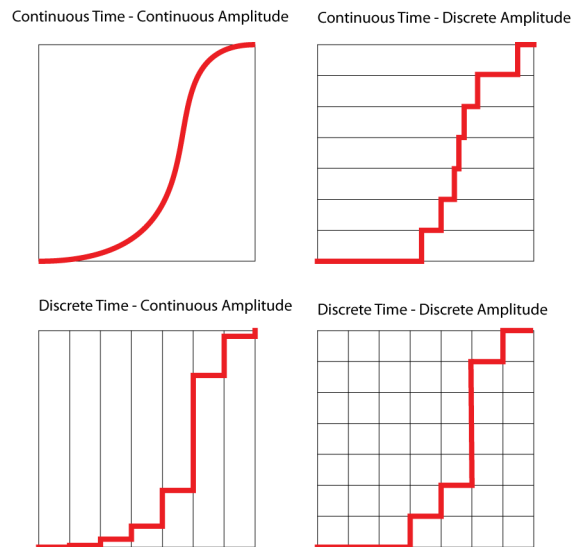

Figure 1.1: The four types of continuous and discrete signal types

You find yourself with a book, yellowpapered, its author powderwiggled and now but shards of calcium crushed beneath the cold, flat Westminster soil, and it tells of mass and of the calculus and of gravity and you read and believe and know that the book in your hands, the warm fire, the table, all are supplicant to the laws of the book sideparted before you (Newton 1984). This is quantization, the process of making infinity countable.

⁵"The idea that anything as subtle and complex as all the manifestations of changes in temperature could be measured and quantified on a single numerical scale was scoffed at as impossible, even by the leading philosophers of the sixteenth century. . . . Temperature was then confounded with all the subtleties of subjective judgment, which easily seem incompatible with a single numerical scale of measurement. How could the height of a column of mercury in a glass tube possibly reflect the rich varieties of temperature—damp cold, dank cold, frosty cold, crisp cold, humid heat, searing heat, scalding heat, dry heat, feverish heat, prickly heat, and so on?" (Jensen 1980, 172)

⁶As an alternative, imagine placing a large Speedo sporting pace clock onto your wall with the words "YOU ARE GOING TO DIE" inscribed on it in blood red letters. (Pocknee 2016)

⁷"Signals are usually classified into four categories. A continuous time signal $x(t)$ has the field of real numbers \mathbb{R} as its domain in that t can assume any real value. If the range of $x(t)$ (values that $x(t)$ can assume) is also \mathbb{R} , then $x(t)$ is said to be a continuous time, continuous amplitude signal. If the range of $x(t)$ is the set of integers \mathbb{Z} , then $x(t)$ is said to be a continuous time, discrete amplitude signal. In contrast, a discrete time signal $x(n)$ has \mathbb{Z} as its range." (Ramachandran 2010, 6.1)

1.2 Optimal and Non-Optimal Quantization

The film maker Michael Haneke, riffing on Godard, once said that film was 24 lies a second.⁸ In this case, a CD is 44,100 lies a second. 44,100 times a second one of 65,536 (2^{16}) discrete integer values tricks us into thinking that we are hearing a continuous sound (Pohlman 1992). A grid so fine that its discrete encoding of time and amplitude appears continuous.

Quantization is the transformation of continuous data into discrete data. The simplest version of quantization is probably rounding, where values which are real numbers (\mathbb{R}) are mapped to the nearest integer (\mathbb{Z}): 0.23 becomes 0; 0.78 becomes 1; 29.547668 becomes 30 . . .⁹¹⁰

. . . but 0.23 is not 0; 0.78 is not 1; 29.547668 is not 30.¹¹ Quantization can result in changes to the signal it operates upon leading to differences between the input and output.¹² This change is known as *quantization error* and comes in two main types: *saturation* and *distortion*. *Saturation* occurs when the input signal exceeds the range of the quantizer (and will not be dealt with in this thesis), and *distortion* is the discrepancy between the input and output signal. One type of distortion measurement is the L_r measure (Ramachandran 2010, 6.3)¹³, defined as:

$$L_r = d(x, y) = \sum_{i=1}^p |x_i - y_i|^r$$

Non-Optimal Quantizers are ones in which there is quantization error, creating a difference between the input and the output, or $L_r = d(x, y) \neq 0$ (Gray and Neuhoff 1998, 2341).

Optimal Quantizers are ones in which the quantized output and its unquantized input are identical i.e. where there is no quantization error and $L_r = d(x, y) = 0$ (Gray and Neuhoff 1998, 2341).

This chapter is split into two main sections, each of which analyses some of my work using one of these two categories.

⁸"I always say film is 24 lies per second at the service of truth. Or at the service at the attempt to find the truth. Because I don't know what the reality is." (Ignoramous)

⁹"A quantizer Q , is mathematically defined as a mapping $Q : \mathbb{R}^p \rightarrow C$. This means that the p -dimensional vectors in the vector space \mathbb{R}^p are mapped into a finite collection of C . This collection C is called the codebook and the number of vectors in the codebook, N , is known as the codebook size. The entries of the codebook are known as codewords or codevectors. If $p = 1$, we have a scalar quantizer (SQ). If $p > 1$, we have a vector quantizer (VQ).

A quantizer is completely specified by p , C and a set of disjoint regions in \mathbb{R}^p which dictate the actual mapping. Suppose C has N entries $y_1, y_2 \dots y_N$. For each codevector, y_i , there exists a region, \mathbb{R}_i , such that any input vector $x \in \mathbb{R}_i$ gets mapped or quantized to y_i . The region \mathbb{R}_i is called a Voronoi region and is defined to be the set of all $x \in \mathbb{R}^p$ that are quantized to y_i ." (Ramachandran 2010, 6.2)

¹⁰"Quantization is the technique of approximating an analog amplitude to form a discrete number. In terms of the quantizing hardware, the number of allowable steps is determined by the length of the data word in bits. Just as the number of digits in our speedometer determined our resolution, the number of bits in our digitization equipment determines its resolution. Two bits would yield four (2^2) possible quantization values: (in binary form, 00, 01, 10 and 11). Eight bits would create 2^8 or 256 steps (ranging from 00000000 to 11111111). A 16-bit word would accommodate 2^{16} or 65,536 values (ranging from 0000000000000000 to 1111111111111111)." (Pohlman 1992, 30)

¹¹"Word length determines the resolution of our digitizing system and hence provides an important specification to measure the system's performance. Yet there will always be an error associated with quantization because the limited number of amplitude choices contained in the binary word can never completely map an infinite number of analog possibilities. Rarely will the chosen step be exactly at the analog value; usually it won't be quite exact. At worst, the analog level we desire to encode will be one-half step away: That is, there will be an error of one-half the least significant bit of the quantization word. For example, suppose the binary word 0010 corresponds to the analog step value of 2.0 V and 0011 corresponds to 3.0 V, and the actual analog value at sample time is unfortunately 2.5V. Since 0010 $\frac{1}{2}$ isn't available, the system will round up to 0011 or down to 0010; either way, there will be an error of magnitude of one-half step." (Pohlman 1992, 30)

¹²"Dr Penelope Gouk has shown that [Isaac] Newton began his experiments [in light for *Opticks*] with the idea that there were only five colors: red, yellow, blue and violet. (He groups these five several times in the *Opticks*, too.) But he subsequently added two more, "to divide the image [of the spectrum] into parts more elegantly proportioned to one another." Hence there occurred to him the analogy with the seven notes of the diatonic scale. In the *Opticks* Newton speaks of the difficulty he had in distinguishing the colors of the spectrum. It appears that it was his assistant, endowed with better eyesight, who divided up the spectrum of sunlight refracted by a prism; and that Newton subsequently discovered, as if by chance, that the proportions of colors were equal to those of the intervals of a eight-note scale on D. But it was certainly Newton who had instructed his assistant to make seven divisions, prompted as one must suppose by the desire for a musical analogy. As a result of this decision, most people today believe unthinkingly that the rainbow has seven colors, called red, orange, yellow, green, blue, indigo and violet." (Godwin 1995, 9-10)

¹³This equation might be familiar as when $r = 2$ this becomes the Euclidean squared distance.

1.3 Non-Optimal Musical Quantization

The grid is a terrible moment for sensitivity and substance.

- Antonin Artaud (Artaud 1968, 80)

You find yourself sweating sub-tropical before consoles and modules; sliders, knobs and speakers; screen-staring, as past the glass just beyond your sky-tinged rectangle lies a room, and a drummer, boulderlike and stool-anchored, beating time to a pulse headphone-pumped. And you hear their rhythm taut through the studio speakers as the software screen-spread in front of you inscribes it into a jagged topography of seismic scratches. Yet when the pounding ends, you see from the machine's inscription how the beat hangs so fluid against the hard grid of the software, how it ebbs and flows against the machine's own digital pulse, and so you click "quantize" and watch as the drummer's will clicks so effortlessly to that of its machine master.¹⁴

We have quantization because we can't store everything. So we place grids on things to make infinity less.¹⁵ Each of these grids is chosen because it preserves what is seen as important and discards all else.¹⁶ The Nyquist theorem gives us a minimum grid size in which all frequencies audible to the average human can be heard when using the Pulse Code Modulation technique used to encode sound onto CDs, hence those 44,100 values per second.¹⁷

Music notation is another grid to make infinity countable. And just like any other grid, it excludes as well as includes. It has built-in error.¹⁸

¹⁴*Just as musical rhythm is expressed in relation to the grid formed by beat and meter, so sequencers map MIDI event timings to a grid determined by a base resolution provided by the software application. To ensure that the placement of an event in time is as accurate as possible, Logic offers a resolution of a 1/3840 note (one tick).

This division allows for a vast range of rhythmical placement, but there will be occasions when you need to adjust the accuracy of events in relation to more musical divisions (eighth notes, sixteenth notes, triplets, and so on). This can be done with *quantization*, which compares events to a chosen resolution and then corrects their time placement by moving them to the nearest position on a beat/time grid." *Logic Pro 8 Beyond the Basics* (Dvorin 2008, 263)

¹⁵*... These solutions are very similar to the standing waves on a stretched string of finite length (say a violin or guitar string) ... A wave-like motion can be set up on the string but it is constrained by the fact that at the fixed ends of the string the oscillation must go to zero. The result is that the allowed standing waves are those for which the length of the string is a whole number of half-wavelengths. The same is true for the stationary state wavefunctions of a particle in an infinite square well. ... Thus the confined particle has *energy levels* - its energy is *quantized* - and the number *n* that labels each wavefunction and its associated energy is called a **quantum number**." (Manners 2000, 70)

¹⁶*Man is divided into three classes, viz. the hare man, the bull man, and the horse man, according to the size of his lingam.

Women also, according to the depth of her yoni, is either a female deer, a mare, or a female elephant.

There are thus three equal unions between persons of corresponding dimensions, and there are six unequal unions, when the dimensions do not correspond, or nine in all ... - *Kama Sutra of Vatsyayana* (Vatsyayana 1963, 37)

¹⁷*Nyquist frequency - the frequency that is precisely one-half of the sampling rate. The Nyquist theorem states that the highest frequency that may be theoretically represented without distortion by a digital audio system is one-half the sampling rate. For CD-quality sound, the sampling rate is 44.1kHz; therefore the Nyquist frequency is 22.05 kHz". Meaning that all frequencies lower than the average 20kHz cut-off of human hearing to be accurately replicated. (Simoni 2006, 282)

¹⁸Oh the grids! The prisons of our spirit! Oh Euterpe, how you bind us to them just as your father fettered the malefactor to the jagged rocks in adamantine bonds infrangible; for the blossom of foraging fire he stole and gave to mortals! (Aeschylus 1952, 40)

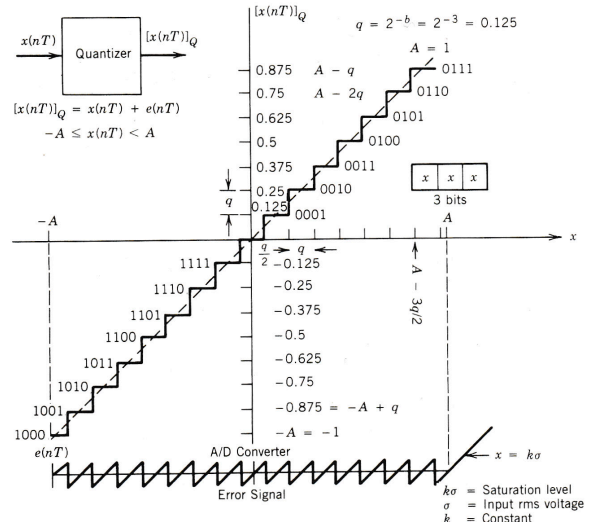

Figure 9.2 Number quantization: Two's-complement rounding for $b = 3$.

Figure 1.2: Example of discrete time discrete amplitude 4bit quantization in an analogue/digital converter using a 2s complement system similar to how CDs are encoded. Notice the bottom line, which shows the quantization error between each step of the grid. (DeFatta, Lucas, and Hodgkiss 1988, 422)

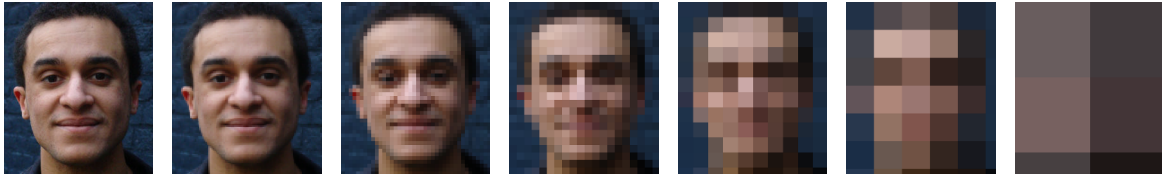

Figure 1.3: Gradually quantized image. Image taken by Ana Lemnaru

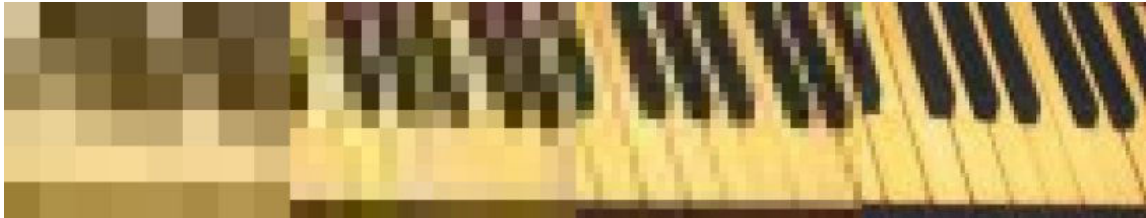

Figure 1.4: Similar image to Figure 1.3 from Peter Ablinger's writing about his *Quadraturen* series (Ablinger 2006).

Rhythm is a grid that scythes time into countable sections. The larger and more uniform the grid, the more it points to the existence of the grid itself. A quantizer is said to be *uniform* if, as in the rounding case, the teeth of the grid are equidistantly spaced. A *non-uniform* grid would be one in which the divisions are irregularly spaced (Gray and Neuhoff 1998)[2325]. Fineness and irregularity allow the lie of the grid to propagate.

You find yourself staring at another computer screen, a photograph of a smiling face stares back, smooth-seeming. As you watch, the pixels, until then invisible to your eye, start to slowly expand and you watch as the image disintegrates into rough-edges, the grid asserting itself, each square averaging all within its compass, until what once was is nothing but a 2x2 grid of four squares of colour, an indistinguishable mush of whichever skin pigmentation least triggers your prejudices. The grid has asserted itself and there is now nothing else. (Figure 1.3)

Or think back to Karlheinz Stockhausen's *Gruppen* for three orchestras, and the way the grid disintegrates, smeared flat not through its removal, but through a non-uniformity and a fineness created through *too many* grids, *too much* quantization - 3 conductors, 3 orchestras in 3 different tempi, within which an orchestra of 109 instruments play material overlaid in pulses at 13 different speeds (Stockhausen 1959).

These 13 speeds can be seen in Figure 1.5a. The layering of these rhythmic grids of different sizes obliterates any perception of a singular pulse by creating a fine and *non-uniform* meta-grid. In *Gruppen*, although each individual pulse is uniform, the composite of all 13 of them gives a non-uniform rhythmic grid. This non-uniformity is used to create smooth gestural shapes (based on vocal formants), as can be seen in the sketches for the work (Stockhausen 1959) (see Figure 1.5b).

It is the non-uniformity of this meta-grid that allows this smoothness to occur.

These are grids of practicality, of the impossibility of notating smoothness needed, and so we fall back on the grid, the world kicking back against our idealism - practicality forcing itself onto our ideas and the grid horsewhispering it into tameness. For we *need* to make infinity countable, we cannot create this smoothness without the reference points of our grids, and so a multiplicity of them erupt in great bubbled swathes of formants. And here, also, in that pragmatism, the gap between the playable and unplayable: Stockhausen's idealized tempi lying in the same relationship as the frequencies in the equal-tempered scale, yet, we see that formal perfection curtailed by practicality, the trailing digits of the tempi, the endless figures of their lizardtails so left behind as predatory life bites down - subjected to the simplest of all quantization processes - that of rounding (see Figure 1.1) ...

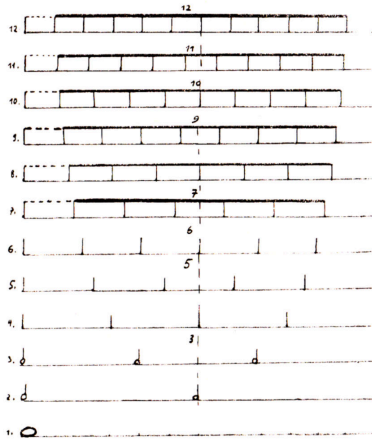

(a) Sketch for Stockhausen's *Gruppen*, showing the 13 pulses and how they are created by equally dividing a whole-note. The effect of overlaying these pulses is to create a *non-uniform* rhythmic meta-grid. (Stockhausen 1959)

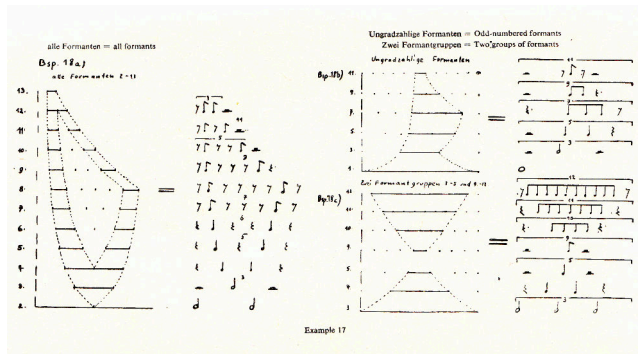

(b) Sketch for Stockhausen's *Gruppen*. Notice the smooth shape of the gestures, this smoothness is accentuated by the non-linear rhythmic grids created through the overlaying of 13 rhythmic pulses (see Figure 1.5a)

Figure 1.5: Sketches from *Gruppen*.

Tempo Scale Used by Stockhausen In The Score Of <i>Gruppen</i>	Tempi Scale Un-Rounded
60	60
63.5	63.5677856615577
67	67.3477228985624
71	71.3524269001633
75.5	75.5952629936924
80	80.0903912502021
85	84.8528137423857
90	89.8984246126009
95	95.2440631180920
101	100.9075698304460
107	106.9078461768410
113.5	113.2649175218030
120	120

Table 1.1: Table showing the tempi used in Stockhausen's *Gruppen* along with the values they would be (according to Stockhausen's article ... *How Time Passes* ... (Stockhausen 1959)) if the score did not round them to the closest half an integer. From (Pocknee 2012b, 40).

speaks softly, does not shout its own name? We must build a grid that is either fine, non-uniform, or both.¹⁹

So, maybe I want to lie to you; make you believe that the discrete is in fact continuous, just like the CD does. Then I need a grid that is extremely fine (like the tiny pixels) or non-uniform (like *Gruppen*).

... In the deep there was boundless darkness and water and fine intelligent spirit, all existing by divine power and chaos. Then a holy light was sent forth, and elements solidified out of liquid essence ... - Hermes Trismegistus (Copenhaver 2000, 13)

Imagine a cosine function - a pure mathematical continuity. But it is not so pure, its mountainous peaks are thin tapering points squeezed inelegantly between large basin-valleys and, as time extends, the extremes of its topography flatten to a single, indistinguishable plain (Figure 1.6). What grid could we apply that preserves the majesty of its contours? What grid could we apply that

¹⁹Also worthy of mention at this point is the composer Þráinn Hjálmarsson's $y = f(x)$ (Hjálmarsson 2012) an animated score for two performers in which the rhythmic outcome is created through the graphing of two continuous functions against each other.

1.3.1 Pragmatic Quantization: *Almost Every*

Almost Every (2015) is a guitar piece which seeks to lie to you - its rhythms seek to make you believe in the existence of that undulating landscape, making the sounds float on the crests of its rippling waves such that the bars of the prison stay hidden. It does this through non-uniform and non-optimal musical quantization.

A metaphor is a metaphor of a metaphor of a metaphor of a metaphor . . .

There is a pulse. It is being played on a stage somewhere. You are in the audience already halfdrunk on mixers but not caring - it's the weekend right? Yes and onstage - though whether you could call it that, empty floorspace, paintsplattered grey concrete and whitewalls cold and wet to the touch - with a woodblock simple and regular one-a-second beating time, no accent, no wavering. And opposite, stood facing, another player, also with woodblock, but waiting, mallet poised as focused and - CHOOK! they guillotine-strike together and whilst that first player keeps their one-a-second clackclackclackclack (that old routine!) the other glides over the top, slightly faster, a 3:2 - a - what would that be? - 90bpm? - a sync-point every three of their beats, and this goes on, and then that first player shifts gears - a 5:4 - faster still - against the other's beat until the other changes - a 3:5 - a slowdown - and on and on and you've seen it before, this thing, in Elliott Carter's *String Quartet No. 1* (1951) (Figure 1.8) or more specifically, this very thing in Ben Johnston's *Pounding Piece* and in David Pocknee's *We Doubled Down The Base Camps* (2015) (Figure 1.10). But it is none of these pieces, it is *Total* (2014) (Figure 1.9).^{20 21}

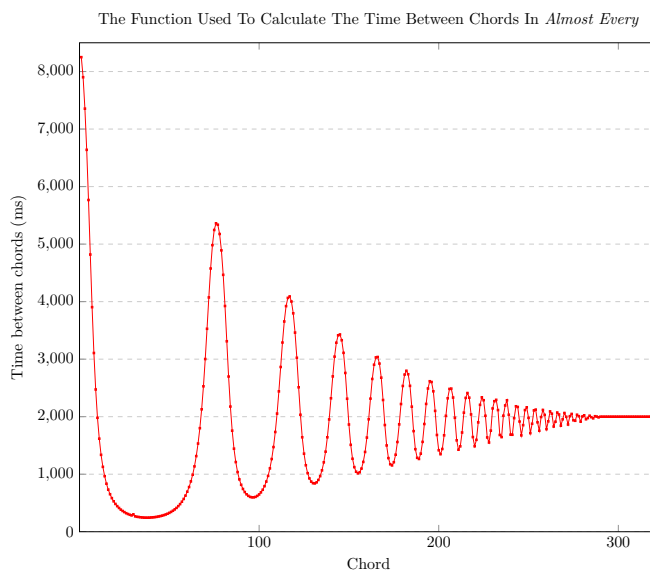

Figure 1.6: Modified cosine function used for *Almost Every*

²⁰I wrote around 50 works between 2013 and 2017. Not all of these are in the portfolio. *Total* is one of these works. The reasons I do this are as follows:

I am an experimental composer.

I write pieces because I cannot imagine them.

This inability to imagine the result sometimes means the outcomes are less than desirable.

Someone once described my work as "covering a wide range of styles: from the very good to the very bad."

I believe that if you are staying true to the ethos of experimental music i.e. producing risky work that you do not know will be aesthetically successful, then you have to expect a high rate of failure.

With such a high failure-rate implicit in the process of making work, the only way to make good work is to make a lot of it.

Over the course of my PhD I have made a lot of work.

As a result of my practice, some of it is very bad.

I have only included works in the portfolio that I think are aesthetically successful. This is so I do not waste your time.

However, all the pieces I have composed have taught me something, even if they fail. Extracts of some of these "failed" pieces are included inside this thesis if they can fulfil an illustrative role.

²¹* [Interviewer:] I have read that you have 2,000 songs registered to BMI.

[Robert Pollard:] That's probably five years ago, that count was probably five years ago.

[I:] And you released something like 50 albums, between *Guided By Voices* and side projects and solo records.

[RB:] Actually, it's closer to 80. . . .

. . . [RB:] We did 100 fucking songs for that album [*Bee Thousand* by Guided By Voices]. That was my theory back then: If we do 100 fucking songs, 20 of them have to be good. . . ."

(Valania 2014)



Figure 1.8: Metric modulation in Elliott Carter's *String Quartet No. 1* (Carter 1951)

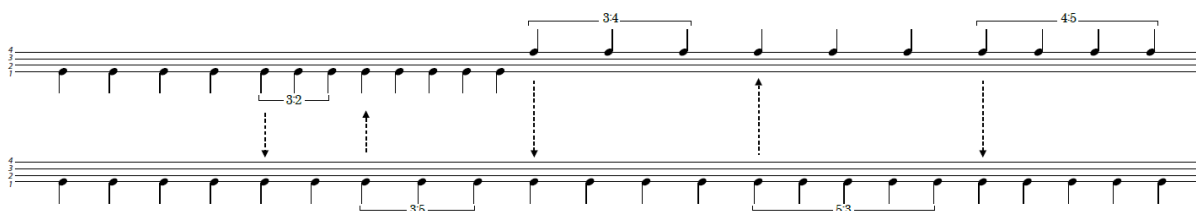

Figure 1.9: Extract of *Total* for two percussionists.

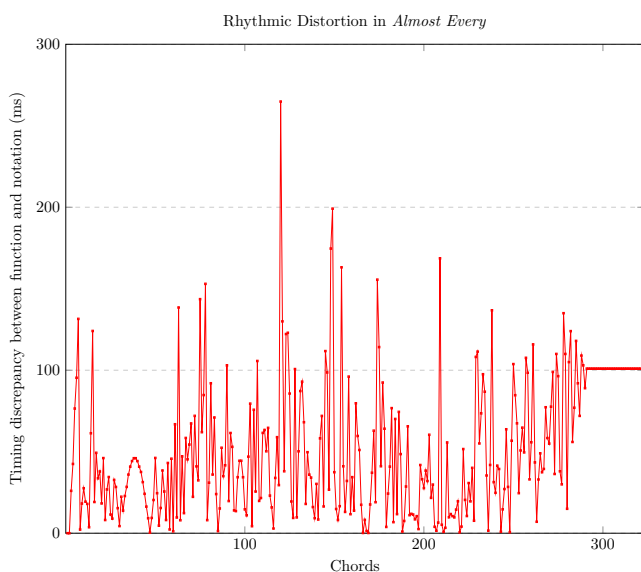

Figure 1.7: Rhythmic Distortion for *Almost Every*

guitar piece *Almost Every* (2015).

In Figure 1.11 you can see a section of this piece - a slow acceleration, the start of that downward move down the steep slope of that first cosine curve, those two lines of rhythms above the chords not meant to sound, but to be counted silently in the head of the player - basement-stage and woodblock players now compressed and still-beating behind the eyes, an ever-contracting heartbeat to hang those lonely stringstrums upon . . .

And so, in each of these works, the same type of notation: one pulse plays, another pulse plays in a simple ratio to the previous one, the first pulse uses the second pulse as a new foundation and plays a new pulse in a simple ratio to it [as Žižek:] andsoonandsoon. . . In *We Doubled Down The Base Camps*

We Doubled Down The Base Camps and *Total* have nothing to do with quantization - that is a different story for a different time - but there is a non-uniformity to their rhythm, players precariously stacking themselves on top of each other so that the pulse drifts and moves, those prison bars stretched and shrunk like rubber. Perhaps we can use their approach to rhythm to create a non-uniform rhythmic grid?

Two people play-off each other's pulses, creating a tuplet of a tuplet of a tuplet of a tuplet of a chaos of an infinity of a tuplet - but we can also take this process, this metaphor of a metaphor of a metaphor and have it happen all inside the mind of one player instead of played out loud by two. We could create a mental drama only the performer is privy to, a way to generate a mental non-uniform grid that they can hang actions upon. This is what happens in the



Figure 1.10: Extract of *We Doubled Down The Base Camps* for violin and cello, showing the tuplet-against-tuplet rhythmic approach .

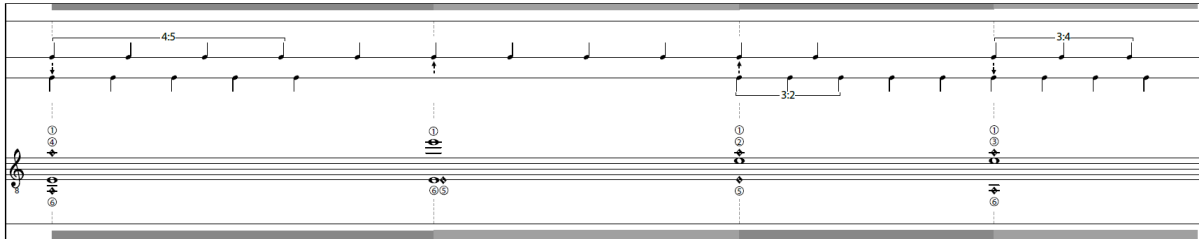

Figure 1.11: Extract of *Almost Every* showing chords 5-8 (quantizations of the inter-onset intervals 5767, 4819, 3904 and 3107ms)

and *Total* this is a dialogue between two players, in *Almost Every* this all takes place inside the player's head.

Making *Almost Every*

Almost Every is a confluence of different algorithms. Each algorithm takes an unbroken continuity and approximates it as a discrete value. *Almost Every* is a cynosure of multi-parametric quantization. But the aim in these grids is not an exploration of the aesthetic space between the gridded and ungridded, but pure pragmatism - the limits of our technologies and humans and musical language.

A lot of modern composition is a constant "saying" of things about instruments - a type of aesthetic colonialism, uncovering the uncharted sonic possibilities of an object; each composer taking an eraser to the "HERE BE MONSTERS" of the unknown and inking in a coastline with their name on it.

In the 1960s as explorers travelled into space (so underwhelmed were they with the undiscovered possibilities of our planet), similarly, composers moved away from traditional instruments to electronics, or instead, sought thrills mapping the Mariana trench of instrumental possibilities.

But what is there to say about the guitar that is left unsaid?

Almost Every is me trying to ink my own coastline, or uncover a new ecology in the inkblack saltwatered strangeness.

Almost Every wants to say one thing: that the guitar has an extensive proliferation of a single pitch-class (E) across an instrument with a much wider range of timbral possibilities than it is usually credited with. This variety is due to the fact its upper and lower strings are made from different materials (wound metal and nylon). These characteristics are different from any other classical instrument.

*Question: What is a good way to highlight the sheer number of possible 'E's on the classical guitar, the chords that can be made from them, and their timbral diversity?*²²

Answer: This sounds like a product specification! But, I would say, by presenting every possible playable chord once only. The ordering would then be important. The chords could be ordered such that, on a small scale, only minimal changes occur between each consecutive chord, causing a listener to focus on the minute differences in timbre within a restricted compass, making the timbral extremes of the instrument seem even larger.²³ This could be coupled with a larger-scale ordering that slowly moves to

²²Perhaps asked by a *Socratici viri*.

²³"But Wait," Price says. "You ain't seen nothin' yet . . ." He pulls his [business card] out of an inside coat pocket and slowly, dramatically turns it over for our inspection and says, "*Mine.*"

Even I have to admit it's magnificent.

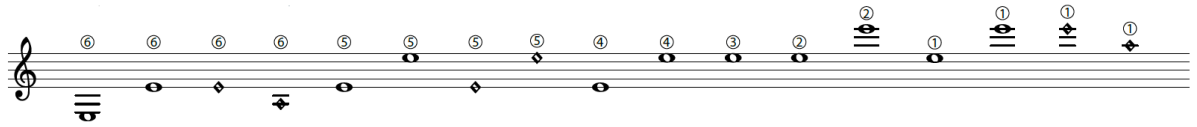

Figure 1.12: The corpus of 17 notes used in *Almost Every*. Taken from the front page of the score.

these different extremes in a way that covers all possibilities allowed by the chords. A further focusing of the way the audience listens to timbre could be done by slowly removing changes in any other parameters.

Q: How many instances of the pitch class E are there on a standard, 6 string, classical guitar?

A: 11 fingered pitches. 6 natural harmonics below the 5th partial. Total: 17 (see Figure 1.12).

Q: Why only use harmonics up to the 5th partial?

A: Because the drop-off in amplitude that happens with higher harmonics makes it difficult to include them in dynamically balanced chords with other notes.

Q: Why only natural harmonics and no stopped harmonics?

A: It is difficult to play stopped harmonics in chords. Also, as these normally involve the relocation of the right hand, this rules out possibilities for exploring aspects of *sul ponticello* and *sul tasto* playing which I thought were important to include to fully explore the timbral possibilities of the guitar. Plus, as you will see, there are plenty of options without stopped harmonics!

Q: Given these 17 pitches, how many possible chords could be made from them?

A: The guitar has six strings, so the largest chord possible would contain 6 notes. The total number of chords containing 1-6 notes using these 17 notes would be:

$$\sum_{n=1}^6 \binom{17}{n} = 21,777$$

Q: How many of these would be technically possible on the guitar?

A: Excluding any combinations which involve notes played on the same string leaves around 7,000 possibilities.

Q: And how many of these would be playable by a human?

A: There is no efficient algorithm for this. I had to test each one by hand.

Q: That must have taken a while.

A: It did.

Q: So, does this piece contain all possible playable chords only using the pitch class E?

A: *Almost*. An earlier version of the work was entitled *Every* and did include all possible chords but was utterly unplayable and didn't sound very good, due to the amount of unavoidable fret noise that occurs in the preparation of some of the more difficult chords. I felt this distracted from the sonority and timbre of the chords themselves, so, for *Almost Every*, I removed all of these chords.

Q: So how many chords did you end up with?

Suddenly the restaurant seems far away, hushed, the noise distant, a meaningless hum, compared to this card, and we all hear Price's words: "Raised lettering, pale nimbus white ..."

"Holy Shit," Van Patten exclaims. "I've never seen ..."

"Nice, very nice," I have to admit. "But wait. Let's see Montgomery's."

Price pulls it out and though he's acting nonchalant, I don't see how he can ignore its subtle off-white coloring, its tasteful thickness. I am unexpectedly depressed that I started this.

- Bret Easton Ellis *American Psycho* (Ellis 1991, 44-45)

A: 319.

Q: *How are they ordered?*

A: As well as testing the playability of each chord, I rated each one according to a set of metrics:

- **Difficulty**[1-9] (1= easiest, 9 = hardest): Each chord was given a rating of how difficult it was to play between 1-9, this was a purely subjective judgement based on playing each one.
- **Number of notes**[1-5]: This rating was simply the number of notes in the chord. The largest playable chord containing only the pitch-class E contains 5 notes.
- **Octave**[1-15]: Each note is given a value between 1-5 based on which octave it sounds at, with 1 being the lowest E on the guitar (the open 6th string, which sounds at the E just below the bass clef), and 5 being the harmonic at the 5th fret of the 1st string (which sounds 3 ledger lines above the treble clef). The value for each note in the chord is then added together to get a composite value for this chord.
- **Number of harmonics**[1-7]: This is a weighted value designed to give much larger values to chords which are primarily composed of harmonics, as opposed to chords which just contain a large number of harmonics. e.g. a 2-note chord containing *only* 2 harmonics would be rated higher than a 4-note chord containing 2 harmonics and 2 fingered pitches:

Let there be a set in which each element represents a note in a chord. If the note represented by a particular element is a harmonic, let this element equal 1, else let this element equal -1. Then, fill the set up with elements all equal to -1 until the set contains 5 members. Sum the values of all elements in the set and add 6. This gives the value. This process is designed so that only chords containing >1 harmonic get values higher than 1.

e.g. If a chord contains 1 harmonic and 1 fingered pitch, first create the set $\{1, -1\}$ then fill the set with -1's until it contains 5 elements: $\{1, -1, -1, -1, -1\}$. Then sum all the elements in this set ($1 + -1 + -1 + -1 + -1 = -3$) and add 6 ($-3 + 6 = 3$).

- All of these values are then scaled to between 0 and 1 to give them equal weighing.

Q: *Sure, that's how you rate each chord, but how do you order them in time?*

A: These ratings are then used to order all 319 chords through mapping them to 4 continuous functions (you can see where this is going ...):

First, let's take three triangle waves and modify their frequencies such that all possible combinations of extremes of their peaks are enumerated i.e. if 1 is the top extreme of a parameter, and 0 is the bottom extreme, and the values of all three parameters at certain points in time can be represented as a 3-bit binary code, then 000, 001, 010, 011, 100, 101, 110, 111 are all represented (see Figure 1.13).

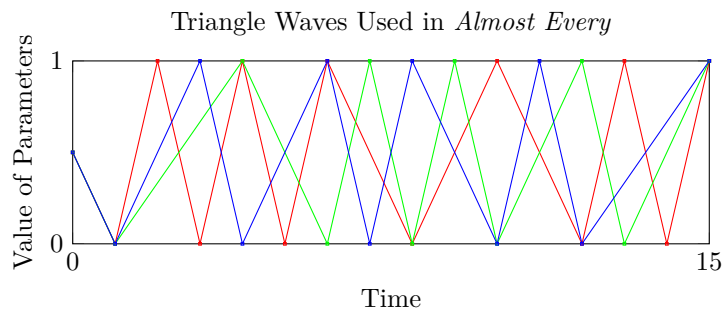

Figure 1.13: Triangle waves used in *Almost Every*

Q: *Why is this important?*

A: These triangle waves will be used for controlling the parameters of the chords and ensuring these encompass all possible extremes of possibilities. This gives the piece moments where specific parametric characteristics become more dominant and ensures the entire timbral space is explored.

Q: *Sorry, but why triangle waves and not a cosine function?*

A: A cosine function results in an unequal distribution of material at its extremes, neglecting the mid-point of its amplitude, unless you modify it, by which point you might as well just use a triangular function.

Q: What then?

A: Next, generate the modified cosine function seen earlier in Figure 1.6 and quantize both this function and all 3 triangle waves (Figure 1.13) such that they become 319 discrete, equally spaced points (one for each chord). We now have 319 points in time, each with 4 values: a duration between each chord (taken from the cosine function), and 3 values from the triangle waves, which will now represent a value in the parameters of *number of harmonics in the chord*, *octaves*, and *number of notes in the chord*.

Given our corpus of 319 chords and these 319 sets of four values, we can now run a Euclidean matching algorithm that takes the three values from the triangle waves and chooses a chord from the corpus which most closely matches these values for each point in the piece. In other words, we take the chord which has the lowest L_r value (in this case, an L_2 value): the chord which has the lowest distortion, and use that chord at this point in the piece. After use, each match results in that chord being removed from the corpus, so that all chords are used once in the course of the piece.

Q: So the triangle waves define the form?

By matching the chords to the values generated by combinatorially ordered triangle waves we can create form by matching the corpus such that the ordering of notes has a parametric profile specified by the triangle waves.

Q: But what about playability? Surely this could mean an unwieldy sequence of difficult chords closely spaced together?

A: Ah! That's where the difficulty parameter comes in! The matching algorithm will also ensure that the chords with the highest level of difficulty ONLY occur during the slowest moments of the piece and the least difficult chords will be used during the fastest sections.

Added to this, the slow movement in between *sul ponticello* and *sul tasto* that happens in the piece is similarly mapped in relation to the triangle wave controlling the amount of the harmonics in the chord. Given that harmonics sing best when played *sul ponticello*, an increase in this triangle wave creates a correspondingly slow movement towards playing near the bridge.

Q: It looks like dynamics are completely independent from the other parameters, though...

A: The dynamics are based on another modified cosine wave whose speed and amplitude gradually decrease over the course of the piece. The aim is that, along with the durations, this movement towards stasis directs the audiences attention increasingly towards timbre by removing these other parametric "distractions".

Q: And what about the way that rhythm is notated? Surely this is another gridding of an already gridded cosine function?

A: Yes, the difficulty of that is also pretty tightly controlled, the ratios in the tuplets are only ones using the integers 2,3,4,5 and 6, so those metric modulations should be easily countable, as opposed to if I used larger integers which might create tuplets which are difficult to count, such as 11:23.

Q: But using smaller integers is also less accurate than using larger integers.

A: Yes, but I think the sacrifice in notational accuracy is more than compensated by the increase in performative accuracy.

Q: But how do you decide on which tuplets to use where?

A: They are all algorithmically chosen - it's another Euclidean matching algorithm that works as follows:

1. Take the duration between chords specified by the cosine function.
2. List all tuplets possible using the prescribed integers i.e. 2,3,4,5 and 6.

3. Take each possible triplet and calculate the duration in milliseconds of all strings of pulses between 1 and 20 in length.
4. Comb through these values to find the amount of pulses in a particular triplet which would give the closest duration to that specified by the cosine function.

Only triplets which give pulses within the range easiest to entrain with and sense tempo are used.²⁴

Q: But couldn't you just notate all of these durations in a single tempo using a minimum duration of 32nd-notes? Surely that would be more easily playable and equally as accurate?

A: As I mentioned before, in a uniform grid, the grid will assert it's presence. With 32nd-notes you will hear the grid, which undermines the illusion of continuity. Also, this would actually be less accurate. The distortion created by the rhythmic quantization of the piece (i.e. the discrepancy between the duration specified by the cosine function and the duration specified in the notation) is $L_1 = 16.599s$ (see Figure 1.7) whereas a quantization to 32nd-notes at 60bpm (125ms) would give a distortion of $L_1 = 20.583s$.

Q: I see. So the work is prevented from being an undifferentiated parade of the note E by ensuring that every possible combination of the triangle waves are used, and the fact that they move so slowly allows minimal change on a local level but larger, directed movements to extremes of timbre on the macro level, with the entire work moving to an increasingly minimal durational and dynamic difference between each consecutive chord to further direct the audience's attention to what is happening on a timbral level.

A: That's right! But, more importantly, in the context of this discussion about quantization, the whole work is based on taking these slow-moving, continuous functions and gridding them up in order to make changes in the work appear as smooth and minimal as possible.

Q: So, it's one big lie, just like the CD?

A: Exactly. I wouldn't want it any other way.

²⁴"Metric entrainment can occur only with respect to periodicities in a range from about 100 ms to about 5 or 6 seconds. In addition, we may grasp a sense of beat or tempo in a subrange of 200-250 ms [300-240bpm] to about 2 seconds [30bpm]" (London 2012, 46). London references Westergaard and produces a table of useful tempos which "correspond to empirical tests for beat perception" and commenting that "beats are most strongly felt at a moderate tempo, around 80-90 beats/minute (600-700ms)" (London 2002, 535-536).

Beats/minute	Interonset Interval (ms)	Comment
30	2000	Too slow to be useful
42	1414	Very slow
60	1000	Moderately slow
80	700	Moderate
120	500	Moderately fast
168	350	Very fast
240	250	Too fast to be useful

1.3.2 Creative Non-Optimal Quantization



Figure 1.14: One of eight ejaculate-covered pieces of A3 paper used to create *Augenmusik I* & *Augenmusik Ib-e*.²⁵

The *Augenmusik* series originates in utter nihilism: all musical material is meaningless.^{27,28}

If all musical material is meaningless, you should be able to just take the most vulgar form of statistical randomness and, if you had a sophisticated enough musical grid, make compelling music out of it. Which is what I did in *Augenmusik I: The Grid Is A Terrible Moment for Sensitivity and Substance for John Cage and Jordan Mackenzie* (2012) for solo piano and *Augenmusik Ib-e* for player-piano and video, in which I gridded up eight A3 pages I had ejaculated on to create a musical score (see Figures 1.14 and 1.15).

This is a type of non-optimal quantization. There is nothing in the process that attempts to preserve meaning from the original input, in fact, the aim of the process is to *impose* meaning directly onto that input through the grids used.

Not that this is a unique phenomena, one might think of Peter Ablinger's *Quadraturen* series and his *phonography*:

"The same thing happens again and again, but each time it's slightly different" could be a passable definition of musical developmental processes, working in an office, or my alcohol-induced black-outs.

Not to denigrate the artform I'm working in by oversimplifying it, but western art music is fuelled by musical development, and musical development is just making stuff sound the same but a bit different. Outside of motivic development, which can be pretty accurately emulated by computers²⁶ (and, at its worst, retroactively sounds like bad algorithmic music (see Hindemith) (Pocknee 2016)) this is a difficult, non-trivial task.

But similar types of relationships between difference and sameness occur when a signal develops a quantization error.

Perhaps by arbitrarily imposing grids over the top of a set of material we could create a type of musical development?

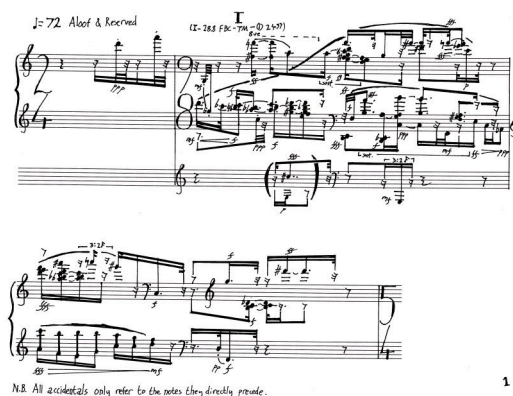

Figure 1.15: First half of Figure 1.14 quantized into musical notation in *Augenmusik I*.

²⁵A technique was used to ensure clear visibility of all the ejaculate on the page, which explains the black coloration. The ejaculate was transformed from its off-white color into black by covering the page in charcoal powder whilst the ejaculate is still wet, and waiting until it dries, at which point the powder adheres to the paper, allowing the removal of any unadhered charcoal and revealing the shape of the ejaculate spread. This is a technique used by the artist Jordan Mackenzie in his own ejaculate works.

²⁶See the work done by the Iamus section of the Melomics programme at the University of Malaga (Melomics) and David Cope's work (Cope 1991)

²⁷I think it is important to separate this from a later position of mine, in which all material should be treated as if it were the same. Treating material as if it is the same means accepting that a C Major chord, a dog barking, an avalanche and somebody being murdered are all musically equivalent; all music being meaningless implies that the only meaning derives from forces exerted on the material, the grids imposed, how it is quantized.

²⁸"The piece has to start with *some* material, but it could have started with others; I simply wrote down a set of notes without thinking about them at all, and said, I will work with these. That's how the piece begins." - Brian Ferneyhough on the opening of *Lemma-Icon-Epigram*, quoted in (Toop 1990, 55).

1. The first step is always an acoustic photograph ("phonograph").
This can be a recording of anything: speech, street noise, music.
2. Time and frequency of the chosen "phonograph" are dissolved into a grid of small "squares" whose format may, for example, be 1 second (time) to 1 second (interval).
3. The resulting grid is the score, which is then to be reproduced in different media:
on traditional instruments, computer controlled piano, or in white noise.

The reproduction of "phonographs" by instruments can be compared to photo-realist painting, or - what describes the technical aspect of the "Quadraturen" more precisely - with techniques in the graphic arts that use grids to transform photos into prints.

When using humanly played instruments the grid has to be enlarged (slowed down) to remain playable - thus the result of the transformation is not so much a reproduction of the original but an approach to or a situation of comparison between instrumental sounds and the original sound source. Using a smaller grain, e.g. 16 units per second (about the limit of the player piano), the original source approaches the border of recognition within the reproduction. With practice[d] listening the player piano can even perform structures possible for a listener to transpose into/understand as spoken sentences.

Actually however, my main concern is not the literal reproduction itself but precisely this border-zone between abstract musical structure and the sudden shift into recognition - the relationship between musical qualities and "phonorealism": the observation of "reality" via "music".

- Peter Ablinger (Ablinger 2006)

Or G. Doug Barrett's *Derivations* series and its gridding of a gridding of a gridding:

Derivation XI is a transcription of a recording of a performance of a transcription of a recording of a performance of a transcription of a recording of a performance of a transcription of a recording of a performance of a transcription of a recording of a performance of a transcription of a recording of a performance of a transcription of a recording (of a performance).²⁹

- G. Douglas Barrett, quoted in (Priest 2013, 88)

At its heart, the set of *Augenmusik* pieces³⁰ are about three things:

1. the power of grids to define meaning
2. the composition of psychological, physical and theatrical difficulty as independent parameters³¹
3. the use of grids as a method of musical development

The same thing happens again and again but each time it's slightly different, like the looping narratives of *Rashomon* (1950) or *Groundhog Day* (1993) or *Run Lola, Run* (1998) or *Source Code* (2011) or *Edge of Tomorrow* (2014) in which the same day was not the same, the same time-period re-worked from different perspectives, with different actions, outcomes. . .³²

²⁹ . . . infinity transcription chaos performance . . .

³⁰ *Augenmusik I: The Grid Is A Terrible Moment for Sensitivity and Substance for John Cage and Jordan Mackenzie* (2012) [pno]

Augenmusik Ib-e (2015) [player-piano and video]

Augenmusik II: Bangscale II: Fantasia (2012) [cl, vln, pno]

Augenmusik III: The Picture of ASKO/Schoenberg (2012) [ob, cl, bsn, hrn, vln, vla, vcl, db]

Augenmusik IV: Paperwork (2014) [fl, cl, pno, vcl] (in portfolio)

Augenmusik V: Blooper Reel (2015) [piano, player-piano] (in portfolio)

Augenmusik VI: Asch (2015) [piano, player-piano] (in portfolio)

Augenmusik VII: Our Syntax: 3 Pulses 1.0 Seconds Apart (2015) [imaginary percussion or analogue clock] (Figure 1.26)

³¹ For more information on this see my paper *Virtuosity, Flow, and Re-Notating Modernism* (Pocknee 2012b).

³² For a more in-depth discussion of this cinematic phenomena see (Heidbrink 2013).

The same thing happens again and again, and each time it's slightly different, like *Augenmusik IV: Paperwork* for flute, clarinet, piano and cello. Here a material, not vulgar but thought-through: 8 interlocking 7-note scales, octave-displaced, each at tempi lying in low-integer ratios to each other (Figure 1.16), and collectively ensuring every note within the compass of the piano occurs once only (Figure 1.17).

Question: What?

Answer: See the "tempo cube", the large box in Figure 1.16?

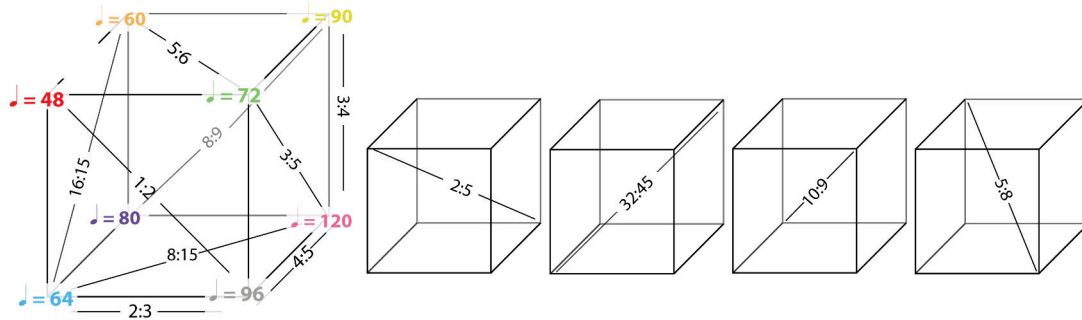

Figure 1.16: Tempo cube used for *Augenmusik IV: Paperwork*.

Q: Yes, what is it?

A: It's a way of geometrically representing tempi, such that their numerical relationships to each other are clear. As you move right along the x axis, the tempi become faster by a ratio of 3:2, if you move down along the y axis, the tempi become faster by a ratio of 4:3, and if you move back along the z axis, the tempi become faster by a ratio of 5:4. The cube is a simple way of visualizing all of the relationships between 8 related tempi. The smaller boxes next to the large one represent the same cube show relationships it would have been too messy to fit in the larger cube. The cube can also be extended out indefinitely in all directions to show further tempi and their relationships.

Q: So, it's a geometric way of representing ratio relationships? Sort of like James Tenney's harmonic lattices (Tenney 2008)?

A: Yes.

Q: Or Euler/Riemann's tonnetz (Tymoczko 2012)?

A: Exactly.

Q: Or, more obscurely, Walter O'Connell's Tone Spaces (O'Connell 1968)?

A: Probably ...

Q: Why is this necessary?

A: Well, imagine if you wanted to write a piece in which 8 different tempi were played simultaneously and you want to write these in a single tempo. The cube shows the ratios between each tempo, which are also equivalent to the tuplets you can use for representing this rhythm in a particular tempo (e.g. if your tempo is 60bpm, then a pulse at 90bpm can be notated in 60bpm using a 3:2 tuplet).

Q: So this acts as an easy reference for solving notational problems?

A: Yes.

Q: So you use these 8 superimposed tempi in *Augenmusik IV: Paperwork*?

A: Yes. I describe these tempi as "pulse-streams" moving at different speeds to avoid any confusion between them and the notated tempo. Each of these pulse-streams consists of a continuous pulse at the given tempo that creates an ascending 7-note scale in which the octaves of these notes have been distributed over the total ambitus of the piano. Each of these scales is different in each of the pulse-streams

and, when superimposed on top of each other, they give all 88 notes of the piano, once only (see Figure 1.17).

Q: So, the distribution of these notes isn't random?

A: No, and in fact, the spread of these notes was carefully chosen so that the range in which the notes occur moves over time to prevent muddy orchestration, as can often happen if the bottom, mid and top ranges are occupied at the same time.

Q: But what's the importance of these pulse-streams and scales?

A: Having these 8 pulse-streams in 8 tempi means that if I quantize all of this material into one of these 8 tempi, one stream will always give the quarter-note pulse, and moreover, this pulse will articulate an ascending scale (these notes are increasingly accented as the piece goes on (see the "Accents" row in Figure 1.18 for where this occurs)).

Q: So how does this piece work? This material is quantized 8 times, once in each tempo?

A: No, 48 times!

Q: That's a lot! What's the duration of this material?

A: Around 15 seconds. Bear in mind that it was originally going to be 64 times! But that was a bit much.

Q: So is the piece just repeating this 15 seconds of stuff 48 times with different rhythmic gridding?

A: Yes. The same thing over and over, slightly different each time.

Q: Where do these 48 quantizations come from, if there are only 8 tempi?

A: Each tempo is given 8 levels of notational complexity, created by starting with the simplest quantization in a given tempo (always quarter-notes) and cumulatively superimposing pulse streams in order of notational difficulty (pulse-streams are considered easier if they lie in low-integer ratios (e.g. 2:3) than in high-integer ratios (e.g. 15:16)).

Q: But that gives 64 (8 × 8) options.

A: As I said, it used to be 64 repeats, but I removed 16 sections, mainly due to time constraints. If you look at Figure 1.18, the removals are indicated by the thick black vertical lines in the top diagram and enumerated at the bottom next to where it says "EXCISED".

Q: What exactly am I looking at in Figure 1.18?

A: At the bottom are the excised 16 sections of material. At the right in the middle is a table further elaborating the tempo ratios shown in the tempo cube. The rest of the Figure is the form of the piece and its 48 sections. You can see the 8 levels of quantization I was talking about in the "Tuplet Ratios Used" row. If you take the 2nd-to-last and 3rd-to-last sections, *AT* and *AU*, you can see the difference between an easy section *AU*, where everything is only quantized to quarter-notes (1:1) and a difficult section *AT* in which any rhythmic tuplet from the list 1:1, 2:3, 4:3, 5:4, 5:3, 5:6, 8:9, 10:9 can be used, in any nesting combination.

Q: This is the two sections shown in Figure 1.19, no?

A: That's correct.

Q: So, from Figure 1.18, it's obvious that the orchestration changes quite drastically over the piece. Is it another "every possible combination thing"?

A: Yes, I couldn't resist it - it's set up so that each instrument gets two solo sections, in which as much of the material as possible is funnelled through that one instrument.



Figure 1.20: *Wedge form* used in Harrison Birwistle's work prior to *Melancholia*.



Figure 1.17: Piano roll screen in Cubase showing the notes used in *Augenmusik IV: Paperwork..* The colour of each of the notes shows which pulse stream it is part of in reference to 1.16

Q: *Obviously the piano would be the only instrument that has all of those notes in its range...*

A: Yes, that's why it occurs at the golden section ...

Q: **sigh*. So the form of the piece is basically starting in the middle and moving further towards the extremes of quantization?*

A: Yes, it's what I think of as a "wedge" form, similar to the wedge shape of the melodic twelve tone row used by Harrison Birtwistle in all his work prior to *Melancolia I* (Hall 1998, 5) (see Figure 1.20) or the gradual opening out embodied in the overall form of Ligeti's *Musical Ricercata, Lux Aeterna* or *Continuum* (Steinitz 2003). The wedge form is a form that starts in mediocrity and travels to two or more extremities.³³ In my work, a similar expanding pitch movement can be seen in the increasing extremity of register of the count-in pitches -

Q: *The what?*

A: In the first $\frac{2}{3}$ rds of the piece, each section starts with one of the instruments giving a count-in to the upcoming section by playing a repeated pitch in the tempo of the next section (see the "Count-In Pitch" row in Figure 1.18). These pitches are mapped to how difficult the section is and become more extreme as the work gets alternately more easy and more difficult.

Q: *What is the result of this wedge-style quantization?*

A: The difference implicit in the types of quantization gradually emerge from the lack of differentiation between sections in the first half of the piece and assert this difference as both types of quantizations move to their extremes, a movement I described in rehearsals as a stylistic dichotomy between Ablinger and Ferneyhough.

Q: *This is really the opposite of Almost Every, where extremity moves towards mundanity.*

A: For sure - "wedge" vs "funnel" form.

Q: *So it's sort of like Raymond Queneau's Exercises in Style (Figure 1.21) (Queneau 1998) in which the same banal story is told over and over again, each time quantized through the grid of a different literary style?*

A: Sure.

Q: *But there's a paradox here, no?*

A: ?

Q: *That the more complex the notation, the closer it is to that original material. But the more complex the notation, the more difficult the performance. The more difficult the performance, the lower the chance that the rhythms will be performed accurately.*

A: And?

Q: *So the more accurately you notate it, the less accurately it will be played, it's that old $\Delta x \Delta p_x \geq \hbar/2$ problem!*

A: I have no idea what you are talking about.

Q: *It means that there is a fundamental limit to the precision with which the position x and the momentum component p_x of a particle can be simultaneously known - Heisenberg's Uncertainty Principle! (Manners 2000).*

A: If you want to see it like that ... I'd see it more as a specifically musical problem.

Q: *[soliloquy]*

Oh what brutish forces the grid enacts!

Substance crippled by their fettered might!

Error springs from complex sight

Paradox that thwarts our acts!

³³For a more in-depth discussion of wedge form, see Chapter 4.



In the S bus, in the rush hour. A chap of about 26, felt hat with a cord instead of a ribbon, neck too long, as if someone's been having a tug-of-war with it. People getting off. The chap in question gets annoyed with one of the men standing next to him. He accuses him of jostling him every time anyone goes past. A snivelling tone which is meant to be aggressive. When he sees a vacant seat he throws himself on to it.

Two hours later, I meet him in the Cour de Rome, in front of the gare Saint-Lazare. He's with a friend who's saying: "You ought to get an extra button put on your overcoat." He shows him where (at the lapels) and why.

(a) (Queneau 1998, 19)



In this new novel, executed with his accustomed *brio*, the famous novelist X, to whom we are already indebted for so many masterpieces, has decided to confine himself to very clear-cut characters who act in an atmosphere which everybody, both adults and children, can understand. The plot revolves, then, round the meeting in a bus of the hero of this story and of a rather enigmatic character who picks a quarrel with the first person he meets. In the final episode we see this mysterious individual listening with the greatest attention to the advice of a friend, a past master of Sartorial Art. The whole makes a charming impression which the novelist X has etched with rare felicity.

(b) (Queneau 1998, 56).

Figure 1.21: Extracts from Raymond Queneau's *Exercises In Style* (Queneau 1998).

1.4 Optimal Notational Quantization

...and maybe you remember how *traduire, c'est trahire* and *traduttore traditore* ...

...and perhaps you remember how Borges claimed of Henley's translation of Beckford's *Vathek* that "The original is unfaithful to the translation" (Lindahl 1999, 20)...

...and perhaps you recall the titles of Peter Heath's two translations of Wilhelm von Humboldt's German text *Über die Verschiedenheit des menschlichen Sprachbaus und ihren Einfluss auf die geistige Entwicklung des Menschengeschlechts*, only 11 years apart:

- *On the Diversity of Human Language Construction and its Influence on the Mental Development of the Human Species (1999)*
- *The Diversity of Human Language-Structure and Its Influence on the Mental Development of Mankind (1988)*

(Harden 2012, 15-16) ...

...and maybe you recall Caroline Bergvall's *VIA (36 Dante Translations)* a collation of the opening lines of every English translation of Dante's *Inferno* held in the British Library as of May 2000 (Bergvall 2011, 81) (Figure 1.22)

...

"*The same thing happens over and over, and each time it's slightly different*", like the belief among composers and performers, almost superstitious, like a rabbit's foot on a rear-view mirror: how things are written changes how they are played.

And maybe my obsession, for years, I can only now articulate ...

Nel mezzo del cammin di nostra vita
mi ritrovai per una selva oscura
che la dritta via era smarrita
—The Divine Comedy, *Inferno*, canto 1 (1–3)

1. Along the journey of our life half way
I found myself again in a dark wood
wherein the straight road no longer lay
(Dale, 1996)
2. At the midpoint in the journey of our life
I found myself astray in a dark wood
For the straight path had vanished.
(Creagh and Hollander, 1989)
3. HALF over the wayfaring of our life,
Since missed the right way, through a night-dark wood
Struggling, I found myself.
(Musgrave, 1893)
4. Half way along the road we have to go,
I found myself obscured in a great forest,
Bewildered, and I knew I had lost the way.
(Sisson, 1980)
5. Halfway along the journey of our life
I woke in wonder in a sunless wood
For I had wandered from the narrow way
(Zappulla, 1998)
6. HALFWAY on our life's journey, in a wood,
From the right path I found myself astray.
(Parsons, 1893)

Figure 1.22: The first few stanzas of Caroline Bergvall's *VIA (36 Dante Translations)* (Bergvall 2011, 82)

Is this:

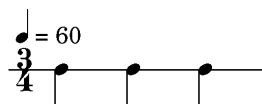

the same as this:

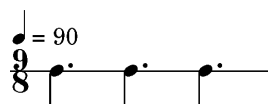

and this:

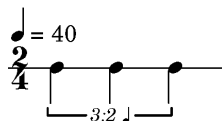

and this:

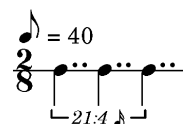

and this:

Play three pulses one second apart.

if not, why not?
and does it matter?

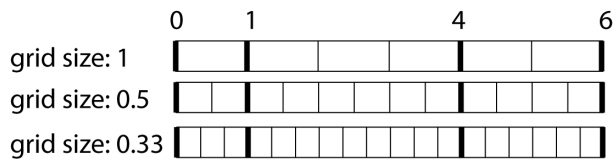

Figure 1.23: Optimally quantizing the numbers 0, 1, 4 and 6 with grids of size 1.0, 0.5 and 0.33.

And you imagine a string of numbers: 0, 1, 4, and 6. And you imagine them gridded again and again, each time the divisions optimally quantizing them. And each time the output is still those numbers, still 0, 1, 4, and 6. And you look again at the previous page. And you look at the notations.

And with scrub-nosed and toothcrushed HB in hand, scribble upon graph paper, calculating the distance between the start of each consecutive note - the inter-onset intervals. And you see they are the same. That the notations represent the same thing: three pulses over three seconds, each one second apart. Yet each notated differently. *The same thing over and over again, but somehow changed each time . . .*

And with scrub-nosed and toothcrushed HB in hand, scribble upon graph paper, calculating the distance between the start of each consecutive note - the inter-onset intervals. And you see they are the same. That the notations represent the same thing: three pulses over three seconds, each one second apart. Yet each notated differently. *The same thing over and over again, but somehow changed each time . . .*

. . . and you remember back to that room and those pulses, three of them over three seconds, each one second apart and each lasting one second, and you know that those overpage notations are the inscription of that event. and what would each option mean for a performer - would those same three pulses come back in a performance just as you heard? or changed somehow, warped by the vicissitude of playing, swung this way or that by the forces enciphered in that ancient symbology? . . .

All of the non-text examples on the previous page are *optimal notational quantizations* of three pulses one second apart. And we might say that these are different from the numbers, that however optimal the notational quantization might be, it changes things. But if we wanted to attempt to prove this difference, how might we do it.

Many of my works are some kind of argumentum ad absurdum. In colloquial rhetorical uses, this technique is often used to highlight the stupidity of another's point, but I apply it in more of an amateur computer coding way - you don't know how the code works, so you change all the variables to 10,000,000 to see what happens.

So, to work out if the notations on the previous page are the same, we might proliferate the possibilities of similarity *in extremis* and see what happens. In other words, how many possible optimal musical quantizations are there of three pulses each one second apart?

Optimal notational quantization occurs through the interaction of three tiers of representation: *Quantization by Metre*, *Quantization by Triplet* and *Quantization by Rhythm*. Mathematics can be used to formalize the calculation of these tiers but, for the sake of good storytelling I relegate this information to Appendix A.

Metre

At the lowest level of metre construction, there is the *tactus* "...metrical intuitions about music clearly include at least one specially designated metrical level, which we are calling the *tactus*. This is the level of beats that is conducted and with which one most naturally co-ordinates foot-tapping and dance steps." (Lerdahl and Jackendoff 1999, 71):

Meter is first and foremost grounded in the perception and production of a pulse or *tactus*. The *tactus* establishes the continuity of musical motion: without it, no sense of meter is possible. But a *tactus* in and of itself, is insufficient for a sense of meter. The *tactus* establishes a single periodicity, and to be sure, this does give the listener a limited degree of temporal expectancy: something should happen on the next beat. Even though this is a type of entrainment, if we were to make a representation of this entrainment in metric terms it would be a series of one-beat "measures":

1. 1. 1. 1. 1 . . .

Musical meters do more than this. Consider a simple duple measure:

1. 2. 1. 2. 1. 2 . . .

. . . At minimum, a metrical pattern requires a *tactus* coordinated with one other level of organization.

(Lerdahl and Jackendoff 1999, 16)

Metre is this "other level of organization", a way of grouping the basic, unaccented pulse of the *tactus*. In the examples which follow, metre is defined by the time signature, which gives both the *tactus* in the denominator (bottom number) and the grouping of the *tactus* in the numerator (top number). This time

signature is then placed in relationship to a tempo, which helps define the speed of the tactus.

Tuplets are a way of presenting a pulse which lies in an integer ratio relationship to the main tactus.

Rhythm is a set of durations that lie in relationships to either the metre or tuplet.

Given that this is a hierarchical ordering, we can then define four possible sets of relationships. These four relationships can be combined to give four notational possibilities, outlined in Table 1.2:

- Rhythm = Tuplet: This is when the pulse implied by the rhythm is the same as the pulse implied by the denominator of the tuplet.
- Rhythm \neq Tuplet: This is when the pulse implied by the rhythm is different from the denominator of the tuplet.
- Tuplet \neq Metre: This is the ordinary situation, in which a tuplet provides a different pulse speed to the metre.
- Tuplet = Metre: This is a special case. When the tuplet is the same as the metre, this could still be considered as a tuplet in a 1:1 ratio, however this would usually be seen as a notational redundancy and so the tuplet would be omitted. e.g. how the top left notation in Table 1.2 could be conceived of as being notated using a 3:3 tuplet.

	Rhythm = Tuplet	Rhythm \neq Tuplet
Tuplet = Metre		
Tuplet \neq Metre		

Table 1.2: Relationships between metre, tuplet and rhythm, illustrated using four notations of three pulses one second apart.

1.4.1 Calculating All Possible Optimal Notational Quantizations

To calculate all possible optimal notational quantizations of the three pulses, first some constraints must be stated, for the sake of playability:

1. No tempi below 30bpm or higher than 150bpm
2. Only use tuplets with denominators featuring the numbers 2, 3, 4, 5, 6, 7 and 9
3. Only use tuplets where the numerator is an integer e.g. no 1.43:4
4. Only use metres featuring notes lasting 0.25, 0.5, 0.75, 1.0, 1.5, 1.75 and 2.0 beats³⁴
5. Only use time signatures with denominators of 4, 8, and 16
6. Only use time signatures where the numerator is an integer

With these constraints, an algorithm was written and the result was a piece of music, for imaginary percussionist or analogue clock (see Figures 1.26, 1.27, 1.28). Each bar presents three pulses, each one second apart, and each lasting one second, yet each notated differently. *The same thing over and over and over again, different each time ...*

³⁴1.25 is not used as there is no simple notational representation for this duration that does not use ties.

171 answers! a grid of 171 choices! Importantly, 171 *optimal quantizations*. In each bar the pulses are all exactly one second apart and last one second $L_r = d(x, y) = 0$. But are they all the same? Were a performer to play this, would we hear the steady unwavering pulse of a metronome, or a drift, and if so - what does this drift mean? How can it be controlled? Is its deviation meaningful?

... and we think of those strange irregularities, of syntax and semantics and grammar coming undone, turning back in on itself like white bloodcells attacking their host, when our sentences mean nothing but nonsense but hold their shape³⁵, like Beethoven in the *Largo* of *Piano Sonata 29* (*Hammerklavier*) (Figure 1.25), or Morton Feldman late works (see Figure 1.24)³⁶, or Luigi Nono's *Fragmente-stille, an diotima* (Nono 1980) and you know not whether they seek to grasp at something more than the page allows or whether this is the sophisticated delight of the Oxford Don of Mathematics Lewis Carroll, as his knowledge of mathematical logic is brought to bear upon the construction of reality, causing it to unravel into acid-tinged streams of thought?³⁷



Figure 1.24: Cello part in bar 883 of Morton Feldman's *Patterns in a Chromatic Field* (Feldman 1981)



Figure 1.25: Extract of the start of the *Largo* in Movement IV of Beethoven's *Piano Sonata 29* (*Hammerklavier*)

³⁵*Of the possible theories which admit such constituents the simplest is that of Meinong. This theory regards any grammatically correct denoting phrase as standing for an object. Thus 'the present King of France', 'the round square', etc., are supposed to be genuine objects. It is admitted that such objects do not subsist, but nevertheless they are supposed to be objects. This is in itself a difficult view; but the chief objection is that such objects, admittedly, are apt to infringe the law of contradiction. It is contended, for example, that the present King of France exists, and also does not exist; that the round square is round, and also not round, etc. But this is intolerable; and if any theory can be found to avoid this result, it is surely to be preferred." (Russell 1905)

³⁶And maybe you've been there, partytrapped in emptying livingroom - RedSea-smashed in that great Kitchen Exodus - as he, beerhanded, undrunk but as much the bore, gentlly sweating in the bodyheated apartment, its windows futile-open-cracked at acute angles that admitted none but the most delicate sliver of coldair, an action as nugatory and empty as cakecutting birthdayprotests *ohnolessthanthat.justasliver.ohishouldn'treally.ohiambeingnaught.killmenow.asifthisisliving.* and he tells of Feldman's genius, of how those notations, those doubleflatted doubledotted nonsenses hint at the something else, a something too profound for me, mere mortal, but beyond the notes, a something which can never be bound in the prison of notation, but escapes past it. something between the notes. [As Žižek:] *and so on and so on...* and you so wished to believe but saw only the emptiness of the void there as sharp laughters shook the kitchenette from the hallway's end, and in that endless screed written in alcoholbreath upon that hot air you knew that there was nothing, that years ago behind the bottlebottom glasses, that bulk, *that* voice, and his sexcrimes, this jumbling of grammar, this crippled syntax and symmetry was nothing but misdirection to keep performers from distraction and comatosis in an unending torrent of nothingness, a music for those who thought experiencing mild *déja vu* for 70 minutes was a good substitute for a profound aesthetic experience. A music, like Rothko - for hotel lobbies. A music "about" memory and time the same way football is "about" gravity. And in a music that meant nothing, that went nowhere, that's own style so circumscribed and defined its soundings, these derangements of writing meant nothing but the simple joy of the child playing in his shit, a joke for those gullible enough to play along. *Freud et mon droit!*

³⁷*It is often said that it is logic that makes *Alice* and *Through the Looking-Glass* great works, and that indeed all Carroll's jokes are jokes either in pure or in applied logic" (Carroll 1977).

Augenmusik VII: Our Syntax: 3 Pulses 1.0 Seconds Apart
for imaginary percussion or analogue clock

David Pocknee

Figure 1.26: Page 1 of *Augenmusik VII: Our Syntax: x Pulses y Seconds Apart*, a work which consists of all possible ways of notating x pulses, y seconds apart, within constraints.

2

The musical score consists of 14 staves, each representing a different time signature and pulse interval. The staves are numbered 58, 62, 66, 70, 74, 81, 88, 95, 99, 103, 107, 111, 115, and 119. Each staff begins with a tempo marking (e.g., ♩ = 100) and a time signature. The music is written in a single melodic line with a treble clef and a common key signature. Brackets under the notes indicate the pulse intervals between notes. The time signatures and pulse intervals are as follows:

- Staff 58: $\frac{5}{8}$, $\frac{5}{8}$, $\frac{5}{8}$, $\frac{5}{8}$, $\frac{5}{8}$; intervals: 3.5, 6.5, 9.5, 12.5
- Staff 62: $\frac{6}{8}$, $\frac{6}{8}$, $\frac{6}{8}$, $\frac{6}{8}$, $\frac{6}{8}$; intervals: 3.6, 9.6, 12.6
- Staff 66: $\frac{7}{8}$, $\frac{7}{8}$, $\frac{7}{8}$, $\frac{7}{8}$, $\frac{7}{8}$; intervals: 3.7, 6.7, 9.7, 12.7
- Staff 70: $\frac{9}{8}$, $\frac{9}{8}$, $\frac{9}{8}$, $\frac{9}{8}$, $\frac{9}{8}$; intervals: 3.9, 6.9, 12.9
- Staff 74: $\frac{1}{4}$, $\frac{1}{4}$, $\frac{1}{4}$, $\frac{1}{4}$, $\frac{1}{4}$, $\frac{1}{4}$, $\frac{1}{4}$, $\frac{1}{4}$; intervals: 3:2, 6:2, 9:2, 12:2, 18:2, 21:2, 24:2
- Staff 81: $\frac{2}{8}$, $\frac{2}{8}$, $\frac{2}{8}$, $\frac{2}{8}$, $\frac{2}{8}$, $\frac{2}{8}$, $\frac{2}{8}$, $\frac{2}{8}$; intervals: 3:4, 6:4, 9:4, 12:4, 18:4, 21:4, 24:4
- Staff 88: $\frac{3}{8}$, $\frac{3}{8}$, $\frac{3}{8}$, $\frac{3}{8}$, $\frac{3}{8}$, $\frac{3}{8}$, $\frac{3}{8}$, $\frac{3}{8}$; intervals: 3:6, 9:6, 12:6, 18:6, 21:6, 24:6
- Staff 95: $\frac{8}{16}$, $\frac{8}{16}$, $\frac{12}{16}$, $\frac{12}{16}$; intervals: 3:2, 6:2, 6:3
- Staff 99: $\frac{4}{16}$, $\frac{4}{16}$, $\frac{4}{16}$, $\frac{4}{16}$; intervals: 3:2, 6:2, 9:2, 12:2
- Staff 103: $\frac{6}{16}$, $\frac{6}{16}$, $\frac{6}{16}$, $\frac{6}{16}$; intervals: 6:3, 9:3, 12:3
- Staff 107: $\frac{8}{16}$, $\frac{8}{16}$, $\frac{8}{16}$, $\frac{8}{16}$; intervals: 3:4, 6:4, 9:4, 12:4
- Staff 111: $\frac{10}{16}$, $\frac{10}{16}$, $\frac{10}{16}$, $\frac{10}{16}$; intervals: 3:5, 6:5, 9:5, 12:5
- Staff 115: $\frac{12}{16}$, $\frac{12}{16}$, $\frac{12}{16}$, $\frac{12}{16}$; intervals: 3:6, 9:6, 12:6
- Staff 119: $\frac{14}{16}$, $\frac{14}{16}$, $\frac{14}{16}$, $\frac{14}{16}$; intervals: 3:7, 6:7, 9:7, 12:7

Figure 1.27: Page 2 of *Augenmusik VII: Our Syntax: x Pulses y Seconds Apart*

The figure displays seven staves of musical notation, each representing a different time signature and pulse/second ratio. The staves are numbered 123, 130, 137, 144, 151, 158, and 165. Each staff begins with a tempo marking (e.g., ♩ = 40) and a time signature (e.g., 2/16). The notation consists of a series of notes and rests, with some notes grouped by brackets and labeled with ratios (e.g., 3:2, 6:2, 9:2, 12:2, 18:2, 21:2, 24:2). The ratios represent the relationship between the number of pulses and the number of seconds. The time signatures are 2/16, 3/16, 4/16, 5/16, 6/16, 7/16, and 9/16. The ratios are 3:2, 6:2, 9:2, 12:2, 18:2, 21:2, 24:2; 6:3, 9:3, 12:3, 18:3, 21:3, 24:3; 3:4, 6:4, 9:4, 12:4, 18:4, 21:4, 24:4; 3:5, 6:5, 9:5, 12:5, 18:5, 21:5, 24:5; 3:6, 6:6, 9:6, 12:6, 18:6, 21:6, 24:6; 3:7, 6:7, 9:7, 12:7, 18:7, 21:7, 24:7; and 3:9, 6:9, 12:9, 18:9, 21:9, 24:9.

Figure 1.28: Page 3 of *Augenmusik VII: Our Syntax: x Pulses y Seconds Apart*

1.5 *Augenmusik V: Blooper Reel* and *Augenmusik VI: Asch*

... he did not want to compose another *Don Quixote* - which would be too easy - but *the Don Quixote*. It is unnecessary to add that his aim was never to produce a mechanical transcription of the original; he did not propose to copy it. His admirable ambition was to produce pages which would coincide - word for word and line for line - with those of Miguel de Cervantes.

- Jorge Luis Borges *Pierre Menard, Author of the Quixote* (Borges 1993, 32)

The same thing happens again and again, but each time it is different like in *Augenmusik V: Blooper Reel* ... SUNG: *once. twice. eight times notated!* ...

Question: I heard your solo piano piece "Augenmusik V: Blooper Reel"; it's the same piece of music played 8 times, right?

A: Nearly. All the pitches stay the same on each repetition, as do all the absolute durations, dynamics and timbre. Only the notation changes each time.

Q: Only the notation?

A: Yes. In *Augenmusik V: Blooper Reel* you hear the same thing eight times and each repetition is an optimal quantization of the same music. If played precisely, all eight repetitions should be identical.

Q: So, supposing an "ideal" performer were to play this piece, a performer who plays every rhythm exactly and precisely as written: then an audience would simply hear the same thing eight times?

A: Yes, but there is no "ideal" human performer.

Q: Because humans play things wrong?

A: No, that's not really the point. Even with a "correct" rendition of each section, each one will be different. The work functions by presuming that, although an absolute measurement of the timings and inter-onset intervals in the notation are identical in each iteration, the rhythms are non-isochronous in respect to performance. This is not simply because the performer performs the work "wrong", but that the syntax of each re-quantization infers a different performative action on the part of the player and a different psychological level of difficulty, which in turn warps their sense of time.

Q: But it is the same thing played 8 times?

A: It depends if you believe that changes in notation impact the way in which a performer executes music.

Q: Oh, I believe that; I don't know if I believe that it impacts the performer in any meaningful way, though. I guess the dealbreaker for me is whether the differences engendered by these different types of notation are larger than the differences that would occur between two performances of the same work - even this work! i.e. Given that musical works in the western art music tradition have historically held on to their ontological identity in performance despite significant performative changes to the inter-onset intervals represented in the score, do the changes in your piece really constitute musical development? Following your logic, every performance of Beethoven's first piano sonata could just be seen as an extended development section that spews outward from the beginning of the piece to cover decades and centuries of its many performances? The same thing again and again, but slightly different. I mean, how different is the notation between each section anyway?

A: Well, I'm using the same tempo cube as in *Augenmusik IV: Paperwork* (see Figure 1.16). The material being gridded is generated through a similar process of placing an ascending scale with displaced octaves into 8 different pulse-streams, although here the scale is chromatic and the original durations for these notes were randomly generated and then quantized into the 8 layer grid, giving a lot more irregularity to the distribution. You can see the differences in notation in Figures 1.29 and 1.30.

Q: Well, they certainly look different, have you got any data about the actual differences?

A: Not for this piece, but I have for *Augenmusik VI: Asch*.

♩=90

p

Figure 1.29: Page 3 of *Augenmusik V: Bloopers Reel*

♩=64

p

Figure 1.30: Page 6 of *Augenmusik V: Bloopers Reel*

Q: That's the one where the player-piano and the pianist are playing exactly the same thing, but the differences in the way they count cause slight offsets in their attacks, a type of flummy, echo-y thing, right?

A: Yes, it's built from an ascending sequence of diminished chord / minor chord resolutions broken up into ten sections, with each section consisting of a series of eight durations notated in ten different tempi.

Q: Are the notations for each tempo optimal quantizations?

A: Yes, it's a similar system to *Augenmusik V*, but the durations are grouped less closely together.

Q: But with ten tempi, you're not using the same tempo cube, right?

A: The tempi in this piece (36, 45, 48, 60, 75, 80, 90, 100, 120, 150) are based around the ratios 5:3, 5:4, 3:4, 4:3, 3:5, 4:5, 4:4, which are also the same ratios of the durations of the chords in each of the ten sections.

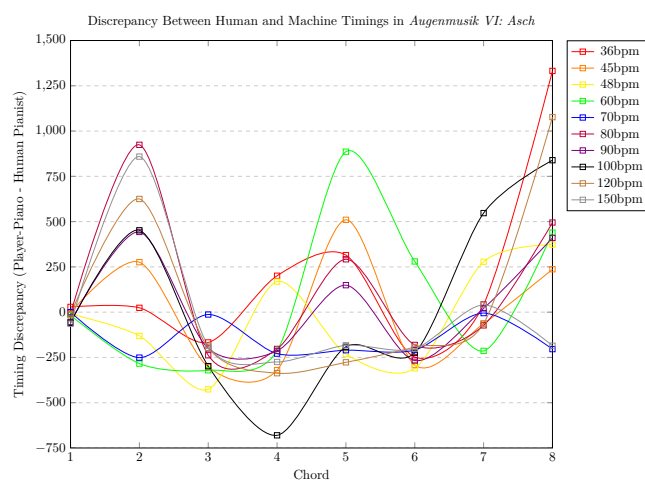

Figure 1.31: Rhythmic Distortion in *Augenmusik VI: Asch*

Q: You said you had some data about this piece, though?

A: Oh, yes. As the pianist and the player piano are playing the same material, I could take a recording of the work and compare the timings of the pianist and player-piano. Whilst in *Augenmusik V: Bloopers Reel* it would be difficult to draw any conclusions about the efficacy of the notation, due to both the notational density of the piece and the difficulty in measuring the onsets in the recording, *Augenmusik VI: Asch* is a much slower and simpler work and so provided an instance where some quantitative analysis could take place. I took a recording of the first performance of this piece (Leo Svirsky vs. Winfried Ritsch's *RHEA* computer-controlled piano system) and transcribed the timings for all of the onsets of chords played by both the human pianist and the player-piano. I then calculated the pianist's deviation in timing from that of the player-piano, which deviated between -680ms and +1332ms.⁴⁰ These values can be seen in Table 1.3.

³⁸ASCH was a musical cipher used by Robert Schumann in piano works such as *Carnaval*, occurring as the four-note chord in its German spelling: A, Es (Eb), C, H (B) (Dale 1952).

³⁹An extreme case of the influence of group pressure is to be found in an experiment carried out by Asch. His subjects were invited to match the length of a given line with one of three unequal lines. The groups consisted of eight persons, and the judgements were given aloud. Seven of the members of the groups, however, had been put up by the experimenter to agree on a judgement which was quite clearly wrong. The unfortunate naive subject was thus faced with a group that violated the evidence of his senses. What was he to do? In the majority of cases, it is true, the naive subjects followed their own judgement against the majority, but many of them showed acute embarrassment in doing so. A third of them, however, yielded to pressure, a few saying that they saw the lines as the majority 'saw' them, most of them saying that they thought their own perception must be wrong . . ." (Spratt 1958, 146)

⁴⁰My margin-of-error for transcription of the piano timings was between -33ms and +18ms.

Q: And those ratios are obviously every possible combination of ratios using the integers 3,4, and 5, right?

A: Obviously...

Q: And how was the order of these ratios chosen?

A: Algorithmically combing through all 15,559 possible permutations in order to find the one which would provide the least amount of notational difficulty over the 10 tempi.

Q: Is the "Asch" in the title a reference to the Schumannian nature of the harmonic language?³⁸

A: A bit, but more the Asch conformity experiment, in reference to the effect of the piano on the human player.³⁹

Tempo	Chord	Pianist (s)	Player-Piano (s)	Difference (ms)
36	1	9.946	9.975	+29
36	2	14.959	14.983	+24
36	3	18.158	17.991	-167
36	4	20.188	20.389	+201
36	5	23.266	23.581	+315
36	6	26.246	25.998	-248
36	7	29.929	29.972	+43
36	8	33.658	34.99	+1332
45	1	47.61	47.608	-2
45	2	52.323	52.599	+276
45	3	55.92	55.617	-303
45	4	58.333	58.013	-320
45	5	60.701	61.211	+510
45	6	63.899	63.607	-292
45	7	67.665	67.602	-63
45	8	72.606	72.843	+237
48	1	87.617	87.607	-10
48	2	92.739	92.608	-131
48	3	96.032	95.606	-426
48	4	97.852	98.021	+169
48	5	101.448	101.217	-231
48	6	103.916	103.606	-310
48	7	107.34	107.618	+278
48	8	112.232	112.605	+373
60	1	127.6	127.583	-17
60	2	132.889	132.605	-284
60	3	135.923	135.602	-321
60	4	138.216	138.003	-213
60	5	140.313	141.199	+886
60	6	143.61	143.89	+280
60	7	147.818	147.604	-214
60	8	152.165	152.604	+439
75	1	164.006	164.006	0
75	2	169.254	169.003	-251
75	3	172.017	172.004	-13
75	4	174.63	174.401	-229
75	5	177.816	177.606	-210
75	6	180.215	180.006	-209
75	7	184.012	184.007	-5
75	8	189.206	189.002	-204

Tempo	Chord	Pianist (s)	Player-Piano (s)	Difference (ms)
80	1	200.012	200.003	-9
80	2	204.085	205.009	+924
80	3	208.243	208.005	-238
80	4	210.011	209.808	-203
80	5	213.306	213.598	+292
80	6	216.185	216.004	-181
80	7	220.084	220.011	-73
80	8	224.508	225.003	+495
90	1	235.386	235.332	-54
90	2	239.893	240.336	+443
90	3	243.535	243.335	-200
90	4	245.955	245.741	-214
90	5	248.79	248.939	+149
90	6	251.601	251.334	-267
90	7	255.313	255.334	+21
90	8	259.923	260.333	+410
100	1	270.193	270.134	-59
100	2	274.683	275.135	+452
100	3	278.437	278.139	-298
100	4	281.207	280.527	-680
100	5	283.923	283.732	-191
100	6	286.356	286.132	-224
100	7	289.589	290.136	+547
100	8	294.287	295.126	+839
120	1	305.148	305.136	-12
120	2	309.51	310.135	+625
120	3	313.337	313.14	-197
120	4	315.868	315.531	-337
120	5	319.011	318.734	-277
120	6	321.329	321.137	-192
120	7	325.195	325.132	-63
120	8	329.057	330.134	+1077
150	1	338.403	338.339	-64
150	2	342.47	343.329	+859
150	3	346.521	346.335	-186
150	4	349.011	348.736	-275
150	5	352.113	351.93	-183
150	6	354.527	354.325	-202
150	7	358.297	358.337	+40
150	8	363.518	363.333	-185

Table 1.3: Timings of onsets of chords played by pianist and player-piano in a recording of the first performance of *Augenmusik VI: Asch*

Q: And what correlations did you find between the nature of notation and the rhythmic realization of the work by a human performer?

A: None.

Q: None!?

A: After running this data through several tests looking for correlations between the type of notation and the type of offset, I could find nothing. The only clear pattern to come out of the data is a sinusoidal type motion in the pianist's offsets, centred around 0ms (see Figure 1.31), which is presumably the result of them constantly correcting their playing to that of the player-piano.

Q: But that has nothing to do with the notation?

A: No, there is no statistical correlation with it that I could find (the full dataset can be found in Table 1.3). I surmise that the fluctuations are probably due to the pianist continually and ineffectively correcting their timing as the piece goes on: *here a bit too fast, so I slow down - oh, wait now I'm too slow so I speed up - oh, now to fast...*

Q: Doesn't that undermine the work in some way?

A: Only if the only reason you ask questions is to get the answers you want.

Q: But you have invested pretty heavily in the idea that the way in which music is written changes the way in which it is played; you've previously written about the idea that each type of notation carries it's own "mass", for instance.

A: Yeah, I have previously implied (in the paper *Time, Flow, Gravity and Uncertainty* (Pocknee 2012a)) that each notational element carries its own mass, a mass which acts upon the psychological and physical faculties of the performer, causing a warping of their experience of time by pushing performers towards or away what Csikszentmihalyi's refers to as "flow".⁴¹ In other words, the notation creates a rubato in the player that is a result of a de-synchronization of the performer's sense of time with that of both clock time and that of the audience. These separate temporal reference frames are a result of the time-warping effects of becoming engrossed in an activity, and my assumption was that romantic styles of rubato came out of the distortions in the perception of time that occur in states of flow. This effect was then replicated, detached from the original mechanism that caused it, and made its way into conventional performance practice.

Q: So Augenmusik V: Blooper Reel would then have a built-in type of musical development via the rubato created through the different types of time-distortions induced by the varying psychological demands of the notation that pushed the performer closer to a flow-state? But this idea, doesn't provide any information on how to compose this type of development, other than implying the vague supposition that more complex forms of rhythmic notation may cause larger displacements from clock time.

A: And perhaps they don't.

Q: [soliloquy]

Heracleitus apparently said that "you can't step into the same river twice"⁴²

Heracleitus apparently said that "you can't stay pinto this aim riff fur twice."

Heracleitus apparently said that "uke aunts to pin toe this aim revert wise".

Heracleitus apparently said that "yuck aren't stay pin tooth is aim reef err two ice".

Heracleitus apparently said that "ewe Kant stay paint oath essay marry fir tow eyes".

Heracleitus apparently said that "Yukon stare pant tow this aim rare fur too ways".

⁴¹For more information see *Viriosity, Flow and Renotating Modernism* (Pocknee 2012b)

⁴²*SOCRATES: Heracleitus is supposed to say that all things are in motion and nothing at rest; he compares them to the stream of a river, and says that you cannot go into the same water twice." (Plato, n.d.)

1.6 The Grid and The Choice

... Jeremiah was Radar-capped as always in these days before the olive green unravelled from constant use, its fabric as worn down by the city as we were, but less angry (as hats are wont to be), and a conversation that circled 'round like polar explorers disoriented in the whiteness (how one leg is always shorter than the other, and without marker, their paths circumscribe the nature of their defect) and the grid and the choice; he said that choice selects the grid, I countered that you need a grid to demarcate reality and give options to choose from, he countered that this grid, in turn, was chosen, and I contended that this choice was made from options demarcated by a grid, which he contended was chosen, which I maintained was chosen from a grid - the same thing again and again, slightly different each time ...

... *grid infinity choice infinity grid infinity chaos infinity* ...

Because quantization defines our options - it is the grid from which all options are chosen: the grid and the choice, ourobourically linked in a determinist deathspiral. An ant mill for two.

And you think of John Cage, and his intention to remove his intention, those hours flipping coins and consulting the *I Ching* for answers, yet the most important things were always the questions.

And you think of the comedian Glenn Wool, and his quip "I'm not even a Christian - well, I was born a Christian - well, I was born and then told about one religion, so I picked it." (Wool 2012).

And you think of the film *Shogun Assassin* (Misumi 1980), of the baby whose random crawl between two objects is suddenly imbued by his father, the Shogun's Decapitator, with a new meaning: "Choose the sword and you join me. Choose the ball, and you join your mother. In death. You don't understand my words, but you must choose." - a quantization - a grid scything the world in two.

And you think of Christie Malry, the protagonist in B.S. Johnson's *Christie Malry's Own Double Entry* (Johnson 2001), and the way the whole world is re-gridded through his obsessive use of the double-entry book keeping system.⁴³

And you think of Alan Lomax's *Cantometrics* - the system for classifying folk singing (Harper 2011, 197-206).

And you think of how the grid so circumscribes the choice, of Luke Rhinehardt's cult 1970s novel *The Dice Man* (Rhinehart 1999). Of how, while Cage's use of chance is generally seen as benign or pseudo-anarchist (Cage 1976), the application of chance does not necessarily preclude value judgements. Of how, in Reinhardt's book, a successful psychiatrist decides that he will start living his life entirely based upon the roll of a dice. Of how the first choice he makes by chance shows how the nature of our own conceptual grids and our ontological quantization fundamentally bias whichever randomness we decide to enact within them in the most extreme way possible:

Then a fog-horn blast groaned into the room from the East River and terror tore the arteries out of my heart and tied them in knots in my belly; if that die has a one face up, I thought, I'm going downstairs and rape Arlene. 'If it's a one, I'll rape Arlene,' kept blinking on and off in my mind like a huge neon light and my terror increased. But when I thought if it's not a one I'll go to bed, the terror was boiled away by a pleasant excitement and my mouth swelled into a gargantuan grin: a one means rape, the other numbers mean bed, the die is cast. Who am I to question the die?

I picked up the queen of spades [lying on top of the die] and saw staring at me a cyclopean eye: a one.

(Rhinehart 1999, 69)

And you think of how our ears quantize a musical pitch interval to "the simplest just interval within a certain tolerance region of what we are actually hearing" (Tenney 2015, 355).

And you think of my quantization processes, that gridding up of those obscene fluids splattered across the driven-snow purity of that A3 topography in *Augenmusik I: The Grid Is A Terrible Moment For*

⁴³"Every Debit must have its corresponding Credit," explained Christie, "Perhaps every bad must have its corresponding good. An extension might be called Moral Double-Entry. In eating these beef olives, which is very good for us, we are at the same time preventing someone else from eating them; which is undoubtedly bad for them." (Johnson 2001, 55)

Sensitivity And Substance (after John Cage and Jordan Mackenzie), and its precedence in John Cage's *Music for Piano* series, his name in the full title.⁴⁴

In *Music for Piano*'s eighty-four pieces, he developed what James Pritchett calls the "point drawing technique" to place on a page of staff paper representing musical events in terms of pitch and time of attack. Cage determined the location of these points by observing the imperfections in a sheet of transparent paper. . . .

. . . placing the penciled, transparent sheet "in a registered way" on the master page, Cage inks the staff and leger lines around each penciled imperfection. This action supplies a grid of *measurement* that allows insignificant imperfections to become meaningful through a system of *inscription*. Those marked imperfections that fall within the space between the staves are inked as filled-in noteheads (signifying nonpitched sounds). In the former case, Cage has performed this operation "roughly", because most marked imperfections will fall in the space between lines rather than directly on them. Therefore, in cases where a mark is close to a line, then Cage simply moved it directly onto the line. This stage of the process could be called *quantization*: a continuous sample is restricted to a smaller number of discrete values. (Piekut 2013, 150)

And maybe you think of the numerical necessity behind de Sade's *120 Days of Sodom*, how "De Sade outlines a closed system of all possible combinations concerning human sexuality, operating within a matrix which contains as parameters the body orifices and the number and characteristics of participants (single-group, old-young, male-female, heterosexual-homosexual, human-animal, living-dead)", one of the first examples of serial thinking in literature (Bandur 2001, 53).

And you think of how Beethoven's usage of the keyboard was fundamentally defined by the size of keyboard used (Pocknee 2015).

And you think of the history of the grid in human civilization and Hannah B. Higgins' *The Grid Book* (Higgins 2009).

And you think of how quantization is so much more than those trivial musical grids of the past pages, but it is a fundament of gridding up the world to understand it, to make infinity countable.⁴⁵

So how do we quantize this PhD Thesis?

1.6.1 Quantizing Knowledge

And all those examples in the last section are quantizations of reality. Each one of these is a readymade waiting to be used, allowing us to grid up infinity.

And we could take any one of these and use them to make something, or simply to see the world differently. They can become *theoretical readymades*: theoretical frameworks imported and imposed wholesale onto a set of material with little concern for their correlation to reality – they may relate to current empirical ideas, or be "fictional" constructions designed to allow the compositional articulation of quanta. Here, it does not matter whether the framework within which people are working is based on accepted ideas of "truth", but simply what it causes them to do. This idea lies at the heart of what a theoretical readymade is. A theoretical readymade is reality, quantized.

As will be seen in Chapter 3, once something is gridded up, the fineness of this grid causes the combinatoric possibilities of the quanta to exponentially increase. Therefore, if we wish to exhaust all possible options, it is necessary to select readymades which are simplistic quantizations with large grids, perhaps even to the extent that they are too simplistic to correlate efficiently with our current understanding of reality.

⁴⁴An easy way to get away with plagiarism is by putting the copied author's name in the title, or by saying it is a "homage" to them.

⁴⁵"Two general and basic principles are proposed for the formation of categories: The first has to do with the function of category systems and asserts that the task of category systems is to provide maximum information with the least cognitive effort; the second has to do with the structure of the information so provided and asserts that the perceived world comes as structured information rather than as arbitrary or unpredictable attributes." (Rosch 1978, 28)

Part 11: The Building Blocks of Language 33

Chapter 3: Building Sounds: Phonetics..... 35
 Chapter 4: Putting Sounds Together: Phonology 57
 Chapter 5: Building Words: Morphology..... 77
 Chapter 6: Creating Sentences: Syntax 95
 Chapter 7: Making Sense of Meaning: Semantics..... 117
 Chapter 8: Using Language in Conversation: Pragmatics..... 133

Figure 1.32: Part of the Table of Contents from *Linguistics for Dummies* (Burton, Déchaine, and Vatikiotis-Bateson 2012, 82)

Principles of PhD Composition

Nearly every music composition PhD thesis I’ve ever read was written as black, double/1½-spaced lettering with a large margin on white, A4 or letter-size paper.⁴⁶

Based on this description, we could then make a distinction between two elements: the design elements (black double/1½-spaced lettering, large margin, white paper, A4/letter-size) and the writing that it contains.

There’s something exciting about working within constraints, it’s why I enjoy generic action movies so much. On one level, they’re predictable - you know there’s going to be a foot chase, car chase, gun fight, fist fight and protagonist vs. antagonist confrontation (probably on a rooftop) - yet the interest is in seeing how the director, actors and artists work within this template. It’s the finesse and imagination of working inside these restrictions that separates your *The Raid 2: Berandal* (2014) from your *Momentum* (2015).⁴⁷ It’s the same reasons you might come back to Beethoven’s piano sonatas, or Gerhard Richter’s squeegee paintings - that sense of "what are they going to do this time?" So let’s not try and reinvent the wheel here; The PhD Thesis is a *genre* of writing with its own conventions, four of these being black lettering, 1½ line-spacing, large margins, and white A4 paper. We can keep these elements (like we might keep a shoot-out in our generic action-movie), but leave every other parameter open for composition.

Adam Harper points out that the process of creating *n-dimensional modernism* involves first selecting variables and then quantizing them (Harper 2011). In the previous swathe of this chapter, quantization has been limited to variables (or parameters), which are musical or sonic. Yet, as I stated in the introduction: *composition* is a set of techniques derived from a historical lineage involving the use of sound, but which can be applied to materials other than those which sound.

But what are the variables of this PhD? In terms of design, two possible composable variables might be the typeface (or "font" when it’s digital) and the position and size of the area on the page where the

⁴⁶Rodrigo Costanzo’s is a notable exception (<http://www.rodrigoconstanzo.com/thesis/>)

⁴⁷Although even the woefully underpowered car chases in *Momentum* are somewhat redeemed by a scene in which someone is beaten to death with a child’s toy truck.

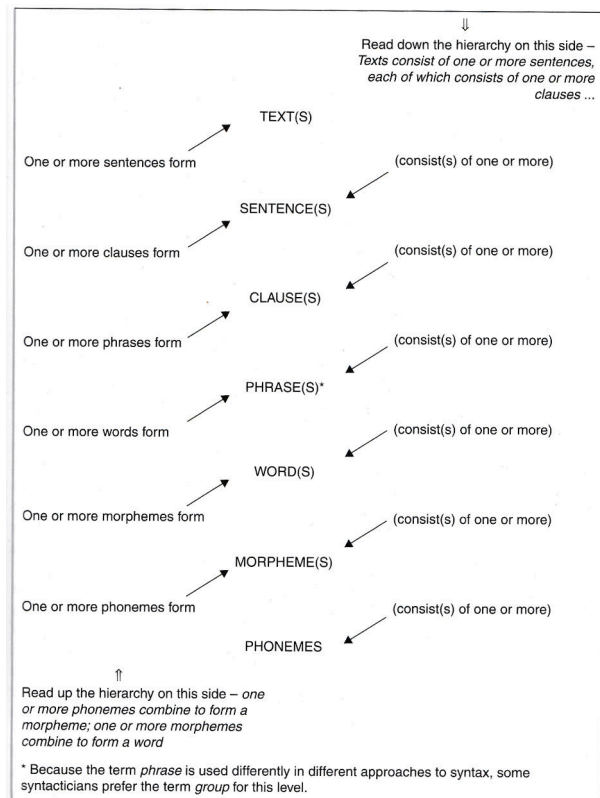

Figure 1.33: Hierarchy of Rank from *Introducing Language in Use* (Merrison et al. 2005, 125)

writing occurs (the page-layout). Both of these elements can be composed to alter the way the text is presented on the page.

PhD Theses are conventionally written using language.⁴⁸ Language is complex, so building a compositional system that deals with language is difficult. This is why theoretical readymades are so useful - instead of trying to build some type of *sui generis* system for composing the language in the Conclusion of this thesis, I can instead draw upon decades of linguistic research to quantize this complex field. But, as stated before, to prevent ourselves having too many combinatorial options - the result of too many variables - the theoretical readymade must be simple.

Figure 1.32 is part of the table of contents from the book *Linguistics for Dummies*. It enumerates six topics - what it refers to as the "building blocks of language". These could be treated as variables to compose the language of a PhD Thesis. The first three of these chapters: phonetics, phonology and morphology are perhaps too small-scale for our uses here - a generic convention of theses is that they primarily use words that already exist⁴⁹ - and these subjects deal with linguistic elements below the word level. Composing with these could result in words that have not existed before, which would make comprehension of the thesis difficult. Similarly, we can ignore "pragmatics", as this applies to spoken language.

This leaves us with *semantics* and *syntax* as compositional variables. According to *Linguistics for Dummies*, semantics is "the study of how humans search for and find meaning in language" (Burton, Déchaine, and Vatikiotis-Bateson 2012, 117). In a PhD thesis, this could be the ideas which are to be communicated, i.e. in this thesis, the semantics of this chapter have dealt with quantization.

The book defines syntax with the following description: "You know how to build sentences because you've subconsciously learned a powerful set of rules and patterns for combining words. Linguists call this set of rules and patterns syntax. People who study syntax, syntacticians, try to figure out exactly what these rules and patterns for sentence-creation are." (Burton, Déchaine, and Vatikiotis-Bateson 2012, 95)

What are the syntactical possibilities for sentence building? Let us supplement this readymade with another one from *Introducing Language in Use* (Merrison et al. 2005), shown in Figure 1.33. This Figure provides a syntactic "Hierarchy of Rank" for language, showing how linguistic elements relate to each other hierarchically. Again, if we discard the *phoneme* and *morpheme* categories, we then have *words*, *phrases*, *clauses*, and *sentences* (to which I would also add *paragraphs*) as compositional variables, all of which then combine to form the *text* at the highest level. These variables could be manipulated independently of each other, similarly to how independent variables were controlled in *Almost Every*.

Given this consideration of possible compositional variables when writing a PhD thesis, we can list the parameters used for composing the Conclusion of this thesis:

1. Semantics
2. Syntax
 - a) Words
 - b) Phrases
 - c) Clauses
 - d) Sentences
 - e) Paragraphs
3. Design
 - a) Page-layout
 - b) Font

The rest of this thesis will explicate the processes by which these different variables can be composed and how this is implemented in the Conclusion. So, let's start with *semantics*. How do you compose the meaning of a PhD Thesis?

⁴⁸This sentence is so heavily hedged that it hurts.

⁴⁹Yes, I know this thesis has already given you a sentence which included the phrase "hamletted, by pubnames everphotocopied to blackstreaks swinging against that greyagain (everpresent)", but in that excerpt I'm combining existing words together to create compound nouns, similar to what you see in German or late (*Dr Sax*-era) Kerouac - so I'm combining existing vocabulary to imply a meaning from two words which already have their own existing meanings, rather than creating a new word from the phoneme-level up, which arrives *zonder* meaning as it has never been used before.

Chapter 1 Bibliography

- Ablinger, Peter. 2006. "Peter Ablinger - Quadraturen." <http://ablinger.mur.at/docu11.html>.
- Aeschylus. 1952. "Prometheus Bound." In *Great Books of the Western World: 5 Aeschylus Sophocles Eurides Aristophanes*, ed. by Robert Maynard Hutchins, 40–51. London: William Benton.
- Artaud, Antonin. 1968. "Nerve Scales." In *Collected Works of Antonin Artaud*, ed. by Victor Corti, 69–88. London: Calder / Boyars.
- Bandur, Markus. 2001. *Aesthetics of Total Serialism*. Basel: Birkhäuser.
- Bergvall, Caroline. 2011. "VIA (36 Dante Translations)." In *Against Expression: An Anthology of Conceptual Writing*, ed. by Craig Dworkin and Kenneth Goldsmith, 81–86. Evanston, Illinois: Northwestern University Press.
- Borges, Jorge Louis. 1993. "Pierre Menard, Author of Don Quixote." In *Ficciones*, 29–38. London: Oxford.
- Burton, Strang, Rose-Marie Déchaine, and Eric Vatikiotis-Bateson. 2012. *Linguistics for Dummies*. Mississauga, Ontario: John Wiley / Sons Canada.
- Cage, John. 1976. *For The Birds*. Boston/London: Marion Boyars.
- Carroll, Lewis. 1977. *Lewis Carroll's Symbolic Logic*. Ed. by William Warren Bartley III. Hassocks, Sussex: The Harvester Press Ltd.
- Carter, Elliott. 1951. *String Quartet No. 1*. New York/London: Associated Music Publishers.
- Cope, David. 1991. *Computers and Musical Style*. Oxford: Oxford University Press.
- Copenhaver, Brian P. 2000. *Hermetica*. Cambridge: Cambridge University Press.
- Dale, Kathleen. 1952. "The Piano Music." In *Schumann: A Symposium*, ed. by Gerald Abraham, 40–41. London: Oxford University Press.
- DeFatta, David J., Joseph G. Lucas, and William S. Hodgkiss. 1988. *Digital Signal Processing: A System Design Approach*. Chichester: John Wiley & Sons.
- Dvorin, David. 2008. *Logic Pro 8 Beyond the Basics*. Berkeley, CA: Peachpit Press.
- Ellis, Bret Easton. 1991. *American Psycho*. London: Picador.
- Everything, Everything. 2012. "Everything Everything - Cough Cough." <https://www.youtube.com/watch?v=cjKcmZGhUrQ>.
- Feldman, Morton. 1981. *Patterns in a Chromatic Field*. London: Universal Edition.
- Godwin, Jocelyn. 1995. *Music and the Occult: French Musical Philosophies, 1750-1950*. Rochester: University of Rochester Press.
- Gray, Robert M., and David L. Neuhoff. 1998. "Quantization." *IEEE Transactions On Information Theory* 44 (6): 2325–2383.
- Hall, Michael. 1998. *Harrison Birtwistle in Recent Years*. London: Robson Books.
- Harden, Theo. 2012. "The Awful German Language, or, Is 'Die Geistige Entwicklung' 'The Mental Development'?" In *Intercultural Studies and Foreign Language Learning: Translation and Philosophy*, ed. by Lisa foran, 13–26. Oxford: Peter Lang AG.
- Harper, Adam. 2011. *Infinite Music*. Winchester, UK, Washington USA: Zero Books.
- Heidbrink, Henriette. 2013. "1, 2, 3, 4 Futures - Ludic Forms in Narrative Films." *SubStance* 42 (130): 146–164.

- Higgins, Hannah B. 2009. *The Grid Book*. Massachusetts: MIT Press.
- Hjálmarsson, Þráinn. 2012. “ $y = f(x)$.” <http://thrainnhjalmarsson.info/works>.
- Ignoramous, Lamos. “Watch “24 Realities per Second” Michael Haneke Documentary.” <http://filmslie.com/24-realities-per-second-michael-haneke-documentary/>.
- Jensen, Arthur R. 1980. *Bias in Mental Testing*. New York: The Free Press.
- Johnson, B. S. 2001. *Christie Malry’s Own Double Entry*. London: Picador.
- Korine, Harmony. 1999. *Julien Donkey-Boy*.
- Lerdahl, Fred, and Ray Jackendoff. 1999. *A Generative Theory of Tonal Music*. Massachusetts: MIT Press.
- Lindahl, James C. 1999. “Anthropological Approaches to the Philosophy of Translation.” PhD thesis, University of Western Ontario.
- London, Justin. 2002. “Cognitive constraints on metric systems: some observations and hypotheses.” *Music Perception* 19 (4): 529–550.
- . 2012. *Hearing In Time*. Oxford: Oxford University Press.
- Mann, Michael. 1986. *Manhunter*.
- Manners, Joy. 2000. *Quantum Physics: An Introduction*. Milton Keynes: The Open University.
- Melomics. “Iamus (Computer).” <http://melomics.com/iamus>.
- Merrison, Andrew John, et al. 2005. *Introducing Language in Use*. London: Routledge.
- Misumi, Kenji. 1980. *Shogun Assassin*.
- Mokoena, Tshepo. 2014. “Clip joint: genius epiphanies.” <https://www.theguardian.com/film/filmblog/2014/nov/11/clip-joint-movies-genius-epiphanies-imitation-game-beautiful-mind>.
- Newton, Isaac. 1984. “Mathematical Principles of Natural Philosophy.” In *Great Books of the Western World: 34. Newton Huygens*, ed. by Robert Maynard Hutchins, 1–376. London: Wiliam Benton.
- Nono, Luigi. 1980. *Fragmente-stille, an diotima*. Milan: Ricordi.
- O’Connell, Walter. 1968. “Tone Spaces.” In *Die Reihe Vol. 8*, ed. by Herbert Eimert and Karlheinz Stockhausen, 35–63. London: Theodor Presser / Universal Edition.
- Paddison, Max. 1997. *Adorno’s Aesthetics of Music*. Cambridge: Cambridge University Press.
- Piekut, Benjamin. 2013. “Chance and Certainty: John Cage’s Politics of Nature.” *Cultural Critique* 84:134–163.
- Plato. n.d. “Cratylus.” <http://classics.mit.edu/Plato/cratylus.html>.
- Pocknee, David. 2016. “Composer Advice.” <http://www.twitter.com/composeradvice>.
- . 2012a. “Time, Flow, Gravity and Uncertainty.” http://davidpocknee.ricercata.org/writing/david-pocknee_time-flow-gravity_2017-09-28a.pdf.
- . 2012b. “Virtuosity, Flow and Re-Notating Modernism.” <http://davidpocknee.ricercata.org/writing/virtuosityzax.pdf>.
- . 2015. “What Some Dead White Guy Did: A Statistical Topology of Keyboard Usage in Beethoven’s Keyboard Sonatas.” <http://cerenem.ricercata.org/articles/beethoven/page01.html>.
- Pohlman, Ken C. 1992. *The Compact Disc Handbook*. Oxford: Oxford University Press.
- Priest, eldritch. 2013. *Boring Formless Nonsense*. London: Bloomsbury.
- Queneau, Raymond. 1998. *Exercises In Style*. London: John Calder.
- Ramachandran, Ravi P. 2010. “Quantization of Discrete Time Signals.” In *The Digital Signal Processing Handbook*, ed. by Vijay K. Madisetti, Raton, FL: CRC.
- Rhinehart, Luke. 1999. *The Dice Man*. London: HarperCollins.
- Rosch, Eleanor. 1978. “Principles of Categorization.” In *Cognition and Categorization*, ed. by Eleanor Rosch and Barbara B. Lloyd, 28–49. Hillsdale, NJ: Lawrence Erlbaum Associates Ltd.

- Russell, Bertrand. 1905. "On Denoting." http://www.hs-augsburg.de/~harsch/anglica/Chronology/20thC/Russell/rus_deno.html.
- Simoni, Mary. 2006. *Analytical Methods of Electroacoustic Music*. Oxon: Taylor & Francis Group.
- Sprott, W. J. H. 1958. *Human Groups*. London: Penguin.
- Steinitz, Richard. 2003. *György Ligeti: Music of the Imagination*. London: Faber / Faber.
- Stockhausen, Karlheinz. 1959. "...How Time Passes ..." *Die Reihe* 3:10–40.
- Tenney, James. 2015. *From Scratch: Writings in Music Theory*. Urbana: University of Illinois Press.
- . 2008. "On 'Crystal Growth' in harmonic space." *Contemporary Music Review* 27 (1): 47–56.
- Toop, Richard. 1990. "Brian Ferneyhough's Lemma-Icon-Epigram." *Perspectives of New Music* 28 (2): 52–100.
- Tymoczko, Dmitri. 2012. "The Generalized Tonnetz." *Journal of Music Theory* 56 (1): 1–52.
- Valania, Jonathan. 2014. "Scalping The Guru." <http://www.magnetmagazine.com/2014/09/19/robert-pollard-scalping-the-guru/>.
- Vatsyayana. 1963. *The Kama Sutra of Vatsyayana*. St Albans: Panther.
- Wool, Glenn. 2012. "Edinburgh and Beyond - Glenn Wool." <https://www.youtube.com/watch?v=10vxsnS04JA>.

Chapter 2

Divination

Hominem Unius Libri Timeo.
"I fear the man of a single book."
- Thomas Aquinas

The PhD is awarded to a candidate who, having critically investigated and evaluated an approved topic resulting in an independent and original contribution to knowledge and demonstrated an understanding of research methods appropriate to the chosen field, has presented and defended the work by oral examination, to the satisfaction of the examiners.
- University of Huddersfield *Regulations for Awards* (Twenty-Second Revision) (Huddersfield 2016, 76)

And I've seen the phrase before, so many times, all hospitalcornertucked neatly into sentences of comma-shy psuedo-legalese, and thought I was as inured to its weirdness as *Call Of Duty*-players to their screens of bloodspattered havoc. Yet it struck me suddenly today with all its strangeness, like the panic of disconnection felt by returning exiles - like repeating a word overandover until it joins dogbarks and birdsquawks in its alienness: "an original contribution to knowledge".

And, in reading, I drifted back to an article by the philosopher Ray Brassier on free improvisation, in which he claims that before we can understand what free improvisation is, we must first define what it means to be free, in the broadest possible sense of the word (Brassier 2014, 2).

And so, in mirrorsympathy, I claim that before we can understand what an "original contribution to knowledge" is, we must first answer the questions of *what knowledge is*, and *how it is contributed to*.¹

I always say that the only difference between naïvety and stupidity is that the former is endearing, and there is a similar fineline between confidence and hubris. So, this chapter won't solve epistemology but it can hopefully point out where practical composition techniques can be used to do PhD research in a way that improves the quality of a thesis.

2.1 In Praise of Love

From the moment I read the *Unabomber Manifesto*, I knew I wanted to be a writer. I love writing, but this document isn't just for my amusement; I am using it to gain a PhD qualification.

To attain the qualification of PhD is to become a "Doctor of Philosophy".

The word "philosophy" derives from the Greek *philosophia* or "love of wisdom/knowledge" (philos=love, sophos=wisdom/knowledge) (*Concise Oxford English Dictionary* 2009, 1077). To become a "Doctor of Philosophy", then, is to become someone in love with knowledge.

This document needs to somehow communicate that love of knowledge. But how can I fall in love with knowledge? To become in love, I must first fall in love. How, then, can I fall in love?

In his book *In Praise of Love* (2012), the philosopher Alain Badiou explains that love is something which occurs from the intrusion of chance and randomness into the everyday. He calls this an *encounter*, and this is where love begins, in this random strangeness trespassing into our lives:

¹As to the "original" part of "an original contribution", you can read the writings of others on the subject, I would only end up copying them. . .

Love always starts with an encounter. And I would give this encounter the quasi-metaphysical status of an *event*, namely of something that doesn't enter into the immediate order of things.

(Badiou 2012, 28)

Randomness and chance are important in enabling the *encounter* and its "wholly contingent, random character" to disturb the existing set of circumstances. As Badiou says, "These really are games of love and chance." (Badiou 2012, 41).

From the encounter, love then goes through a process of change: "love encompasses the possible transition from the pure randomness of chance to a state that has universal value." (Badiou 2012, 16), namely that chance "must turn into a process that can last. This is a very difficult almost metaphysical problem: how can what is pure chance at the outset become the fulcrum for a construction of truth?" (Badiou 2012, 41).

This transition occurs through a declaration of love: "To make a declaration of love is to move on from the event-encounter to embark on a construction of truth" (Badiou 2012, 42), "[a] declaration of the "I love you" kind seals the act of the encounter, is central and constitutes a commitment" (Badiou 2012, 35).

To fall in love, then, there must be an *encounter* and an encounter is random and contingent. Perhaps this is the first step towards falling in love with knowledge, to introduce randomness and chance? And then to transform this encounter into a construction of truth. In research, a Reference List is a declaration of love for knowledge.

And the randomness of divination can be a means of generating the *encounter* itself...

2.2 John Cage at UC Davis

And here we find our *Exhibit A*, the country still moonlanding-fresh as John Cage began as artist-in-residence at the University of California at Davis in the Autumn of 1969 (Nicholls 2007, 84). He ran a class, entitled *Music in Dialogue* (course number 198), ostensibly set up to explore "inter-relations among the arts" (Revill 1992, 231). But attendance swelled (as it is wont to do when you state you will award all participants A grades because you are "opposed to the grading in schools" (Kostelanetz 1988, 251)). With class greatly enlarged, he scrapped his original idea of exploring the connections between music and mycology, and Erik Satie's furniture music "in favor of finding what a large group could efficiently accomplish" (Dinwiddie 2011, 235). So instead of the most Cageian of lectures, the course became an experimental group-learning workshop which re-purposed the chance procedures he had been using for the composition of music to generate new knowledge:

Cage's class was anarchic: 120 students, divided into fourteen smaller groups of flexible membership, read 120 different selections from books in the university library (these chosen by means of the *I Ching*) and then discussed and acted upon their readings in any way they chose (the results included recipes, poetry, compositions, a film and a chain letter).

(Pritchett 1996, 158)

Here then, we have an *encounter* in the field of knowledge - randomness intruding into the normal order of the classroom, Cage as *ignorant schoolmaster*: not teacher but student, him claiming that the course has "as its hypothesis that we didn't know what we were going to study and that we wouldn't divide ourselves into students and non-students: all of us, including myself were students" (Cage 1976, 89).

2.3 Epistemology

2.3.1 Epistemological Constructivism

There are some things you can't unread, that grow like fungus in the brain. For some its Deleuze, whose writings should be studied as virology rather than philosophy, so infectious are they; for me its Baumol and Bowen's *Performing Arts: The Economic Dilemma*; for Cage it's Richard Buckminster Fuller, and Marshall McLuhan amongst others. He quotes McLuhan, from *The Agenbite of Outwit* (McLuhan, n.d.),

in describing his UC Davis class, stating that when each of the groups met to exchange information on what had been read "[i]t was a technique fulfilling McLuhan's wish. He considers that our work must henceforth consist in brushing information against information." (Cage 1976, 89). This seems to describe a type of epistemology known as *constructivism* (or *constructionism* in the field of social psychology, where an emphasis is placed on the sociological/psychological, rather than the pure epistemological perspective (Burr 2003, 2)). Constructivism proposes that "all knowledge is constructed and that the instruments of construction include cognitive structures that are either innate [as in Chomsky] or are themselves products of developmental construction [as in Piaget]." (Noddings 1995, 7). I will be using the terms *constructivism* and *constructionism* interchangeably, as my interest is in their common ground - namely:

...that "reality" is ultimately *noumenal* - that is, it lies beyond the reach of our most ambitious theories, whether personal or scientific, forever denying us as human beings the security of justifying our beliefs, faiths, and ideologies by simple recourse to "objective circumstances" outside ourselves. Instead, the hard-won organization that we impose on the world of our experience is a precariously human construction, supported by our private and shared quests for a modicum of order and predictability in our lives as well as by our need to find some grounding for our actions.

(Neimeyer 1995, 3)

Constructivism does not locate the generation of knowledge in the positivist, scientific or empiricist views of science, which assume that the nature of the world can be revealed by observation. In fact, it warns us "to be critical of the idea that our observations of the world unproblematically yield its nature to us, to challenge the view that conventional knowledge is based upon objective, unbiased observation of the world." (Burr 2003, 3). Instead, it sees knowledge as being *constructed* in the interactions between people :

... If our knowledge of the world, our common ways of understanding it, is not derived from the nature of the world as it really is, where does it come from? The social constructionist answer is that people construct it between them. It is through the daily interactions between people in the course of social life that our versions of knowledge become fabricated.

(Burr 2003, 4)

2.3.2 Knowledging

Knowledge is fabricated. It is made. Not found or discovered.

Constructivism defines knowledge not as a thing that you go out and find, but as process, an activity, a verb. Yet the word "constructivism" is itself a noun, reifying the very thing it seeks to argue is an activity (this is a process rife in academic writing, known as *nominalization*, in which verbs are converted into nouns (Sword 2012)). In order to combat this linguistic hypocrisy, I would like to propose a new piece of vocabulary, inspired by the musicological literature. In his 1998 book, the musicologist Christopher Small tries to combat a similar nominalization process that has occurred with the word "music", stating that "[m]usic is not a thing at all but an activity, something that people do. The apparent thing 'music' is a figment, an abstraction to the action, whose reality vanishes as soon as we examine it at all closely." (Small 1998, 2) This approach mirrors that of the constructivist stance towards the abstraction of "knowledge". To get around this problem, and reorient discussion towards music as an activity, Small de-nominalizes the noun "music" to create the term *musicking*.

So far as I know, the word *musicking* does not appear in any English dictionary, but it is too useful a conceptual tool to lie unused. It is the present participle, or gerund, of the verb *to music*. This verb does have an obscure existence in some larger dictionaries, but its potential goes unexploited because when it does appear it is used to mean roughly the same as "to perform" or "to make music" - a meaning that is already well covered by those two words. I have larger ambitions for this neglected verb.

I have proposed this definition: *To music, is to take part, in any capacity in a musical performance, whether by performing, by listening, by rehearsing or practicing, by providing material for performance (what is called composing), or by dancing.*

(Small 1998, 9)

Small allows this re-orientation and change of perspective and focus through de-abstracting a term and de-nominalizing it. This allows focus on the activity rather than the result.

Taking Small's musicological de-nominalization as inspiration, I would like to propose a new piece of terminology for the field of epistemology: *knowledging*.

From the viewpoint of an epistemological constructivist, there are many benefits to using this term over "knowledge". As "knowledge" is a noun, it immediately implies a concreteness and fixity which constructivism negates, and, by transforming it into a verb, it instead re-defines knowledge as a process and an activity, divorced from ideas of an unchanging "truth" which are embedded in the concreteness of its nominalized form.

I propose this definition: *To knowledge, is to take part, in any capacity in the generation of knowledge, whether by reading, by writing, by musicking, or by any other verb.*²

Cage's use of chance procedures upon the library can then be seen as a specific type of *knowledging* using chance to generate the *encounter*.

2.3.3 Knowledging Through Chance

Discovery in science happens in many ways. Introductory biology courses can give the impression that a scientist goes into the lab every morning as if it were a 9-to-5 job, armed with a "to do" list for the day - observations, hypothesis, experiment, results, and conclusions. But as anyone who has explored nature knows, science rarely, if ever, proceeds by a process as rigid and ordered as "the" scientific method. Hunches, intuition, gut feelings, and sheer luck have as much to do with discovery as careful planning of experiments.

(Lewis 2009, 2)

And maybe it was the lies we were told in school, inbetween forests of lit bunsenburners flickering like the tops of black turrets littered across an oilfield, dullreflected off that eversticky oldvarnish, canyon-carved with deskgraffiti from compasses now pencilcasestuffed . . . or maybe it was the endlesscycle of celebrity atheists - every second somewhere in the world another enters or exits another auditorium of endlessclapping, like Indiana Jones and father chair-tied, endlessly spinning in the fireplace . . . or maybe it was an easyfill for the hole of everemptiness . . . I don't know, but at some point we started believing the myths about how science works.

And this infected our ideas about what research in the arts is or should be, like John Croft oldman-cloudshouting in his *Composition is not Research* article (see (Pocknee 2015b)).

But some of our greatest discoveries happen by chance.

The history of science and technology abounds in examples of innovative ideas, which seem attributable, above all, to chance. Well known examples are the pneumatic tyre and the carburettor. In Dunlop's time, bicycles were called 'boneshakers' because of their solid tyres. When Dunlop was watering the garden, he realized that the garden hose offered resistance when pressed; the idea for the pneumatic tyre was born. Durea got the idea of the carburettor from the perfume vaporizer, The Velcro case is a more recent example. The Swiss George de Mistral was amazed to find that the seeds of the burdock root had attached themselves so strongly to his dog's coat and thus he got the idea for Velcro.

(Roozenburg and Ekels 1995, 187)

The process of discovery in the above examples could be described as *bisociative* thinking. *Bisociation* is a term coined by Arthur Koestler in his book *The Act of Creation* (1964). Bisociative thinking is the opposite of associative thinking: "Informally, bisociation can be defined as (sets of) concepts that bridge two otherwise not - or only very sparsely - connected domains[,] whereas an association bridges concepts within a given domain." (Berthold 2012, 2) In other words, in the examples above, one idea (gardening/perfume/dog-walking) is connected to another unrelated idea (bicycle engineering/auto mechanics/adhesives) to create something new (pneumatic tyre/carburettor/Velcro).

²This definition may seem recursive or circular, as it defines knowledging in reference to knowledge, yet does not define knowledge itself, but this is because I do not wish to define knowledge - that is a job for real philosophers. I believe that whether reality is *noomenal* or not is ultimately a matter of faith and unprovable, and so this question is deliberately avoided. Instead, the re-orientation of the discussion from the thing itself (knowledge) to the activity (knowledging) is done for practical reasons, explained later.

Importantly, the process of bisociation is often grounded in an *encounter*, in which the two planes of knowledge collide, and that this encounter is grounded in randomness and chance, a moment when "two trains of thought, each of which is independently sensible, collide in a way which jars or surprises our normal powers of association" (Baxter 1995, 51). Randomness is a powerful tool for generating bisociative knowledging.

Although not connected to Koestler's ideas, which occurred later, Cage's 1969 class created a situation ripe for bisociative thinking, with an eyewitness describing that the books randomly selected "included such subjects as firefighting techniques, Pakistani agrarian economics and Islamic art" (Dinwiddie 2011, 235) the type of disparate, unconnected subjects that would be conducive to bisociation.

Bisociation itself is not *about* chance or randomness, although these may be used as techniques for generating a situation conducive to bisociative thinking. Instead, "[b]isociative thinking occurs when a problem, idea, event or situation is perceived in two or more "matrices of thought" or domains . . . it is the ability to perceive something from two unrelated knowledge bases. When two habitually independent matrices of perception or reasoning interact with each other, the result is either a *collision* ending in laughter, their *fusion* in a novel intellectual synthesis, or their *confrontation* in a new aesthetic experience." (Dubitzky et al. 2012, 13-18)

2.3.4 Non-Chance Bisociation

... we that are young
Shall never see so much, nor live so long.
King Lear (Act V, Scene III)

While chance can be used to create bisociative situations, as in the Cage example, it can also occur through the hard work of imaginative thinking.

The most amazing thing about Deleuze and Guattari's *A Thousand Plateaus* (2004) is not the text itself, but the endnotes and bibliography.

There is perhaps no better modern example of the possibilities of knowledging - of epistemological constructivism - than this work. As I have mentioned elsewhere, Deleuze & Guattari's writing involves a synthesis of extremely disparate pieces of knowledge to draw out larger conceptual themes:

... when Deleuze and Guattari propose their idea of the "smooth" and the "striated" in the fourteenth chapter of *A Thousand Plateaus* (Deleuze & Guattari, 2004, pp. 523-551), they explain it through analogies to Seventeenth-Century quilt making (pp. 525-526), Boulez's music (pp. 527-528), nautical navigation (pp. 528-530), Riemannian topology (pp. 532-5537), the division of time under capital (pp. 541-542), and nomadic art (pp. 551).
(Pocknee 2015b, 9)

There seems nothing implicit in these subjects which warrants their being placed together. Instead, we see two formidable and voracious intellects using these disparate ideas to synthesize new knowledge. They are "brushing information against information", creating *encounters*.

Similarly, the following example from the field of chemistry shows the solving of a problem not through a thinker's confrontation with a new chance-generated experience but from the synthesis of their own existing knowledge:

Harry Kroto, a professor from Sussex University, and his co-workers Bob Curl and Richard Smalley from Rice University in Texas, puzzled at length over how to arrange 60 carbon molecules into a uniquely stable shape. The breakthrough refused to come, until Kroto's thoughts drifted back to the famous geodesic dome that Buckminster Fuller had designed for EXPO '67 in Montreal. Kroto also remembered a three-dimensional map of the stars he had made years ago for his children. Both the dome and the map had been made up of pentagons and hexagons . . .
(Baxter 1995, 66)

Or, more musically, we could think of how the theorist Johannes Tinctoris's ideas on rhythmic notation in his Fifteenth-Century treatises *Expositio manus* and *Proportionale musices* were derived from contemporary changes in accounting practices rather than musical ideas (Higgins 2009, 115).

Deleuze and Guattari are much quoted in the arts. However, the main mistake writers make is in adopting the style³ and substance of Deleuze and Guattari's writing rather than the way in which it is made. In other words, they take the knowledge but not the knowledging. *A Thousand Plateaus* contains a series of all-encompassing conceptual frameworks which are illustrated using an enormous and eclectic range of resources, leading me to wonder "how interesting is it to claim that your work has parallels with Deleuze and Guattari's idea of 'the smooth and the striated' when it is patently obvious that this theory can be used to encompass anything, given the enormous diversity of references that are used when illustrating it in the philosophy itself[?]" (Pocknee 2015b, 9).⁴

Deleuze wasn't the worst thing to happen to the Arts. The Arts were the worst thing to happen to Deleuze (Pocknee 2016).

So how can I copy what Deleuze and Guattari have done to create my own *encounters*? The main problem is that, as the quotation at the start of this section indicates, it is impossible for someone of my age (31) to have read the same amount of books as *two* people in their fifties.

But, perhaps I can adapt the type of knowledging Cage used at UC Davis to generate a similar breadth of references ready to be synthesized, whilst avoiding the problem of trying to write anything as erudite and wide-ranging as the much older and wiser Deleuze and Guattari. Perhaps Cage-ian knowledging can fabricate the same level of diversity needed for bisociation without having seen so much, nor lived so long.

2.3.5 Intellectual Singularities and Compactness

And I can remember the moment I knew I was fucked.

You can tell a lot about a person from looking at the books on their bookcase. And going through their bins. And I was stood, headtilted, eyes drifting over the crackedspines, shifting to unblind yellow bulblight shatterfracted from the titles of the newer additions, in the lounge of a friend. And it hit me: all of the books on the bookcase were ones I already owned or was thinking about buying. And this was yearsbefore, before the thinkpieces about our "bubbles", before we noticed political discourse had become the endlessyelling of wrestling. Me and my friend had reached what I call an *intellectual singularity*, the point at which a social group finds the loci of its intellectual horizons circumscribed by the same forms of thought and intellectual reference points. So, go to a friend's house, look at their books and films: the number you have in common is a function of your nearness to an intellectual singularity.

Intellectual singularities are not conducive to bisociative thinking. Intellectual singularities are filled with redundancies. And we could think of Cage's claim that he dropped out of college because it was a "waste of people" for everybody in a class to read the same book, rather than one person reading it and sharing their insights (Kostelanetz 1988, 252). We could calculate these redundancies through using graph-theory to model a network of information and assess its *compactness*. As a simple example, Parise, Whelan and Todd (2015) ran an experiment to try and correlate the diversity of a person's twitter network with their ability to generate innovative ideas, using a *compactness ratio* to measure the degree to which people in the network are connected to each other. They concluded that cohesive networks with a high compactness ratio (i.e. those with lots of interconnected nodes) "provide more redundant information, which our research shows is negatively correlated with ideation" (Parise, Whelan, and Todd 2015, 22) (see Figure 2.2). In other words, if all of the people in a twitter network are connected to each, innovative ideas are less likely to occur.

Bisociation, then, could also be seen as a function of the compactness of a network of ideas. The bisociation between two matrices of thought can only exist if there is some lack of connection between the two domains. Bisociation can be seen as a *bridging* between graphs (see Figure 2.1 and (Kötter and Berthold 2012) for more details).

³See Rule and Levine's paper on *International Art English* (Rule and Levine 2013).

⁴ "Philosophy is for the artist, especially for some painters nowadays, much as the Bible is to the minister, which is to say a respectable source that can be used to justify anything." - Barnett Newman (quoted in (Kostelanetz 1993))

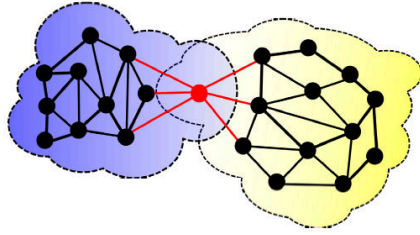

Fig. 6. Bridging concept

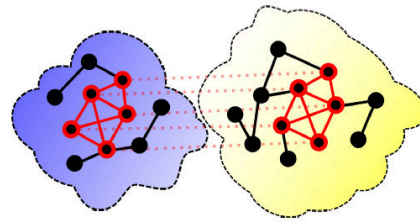
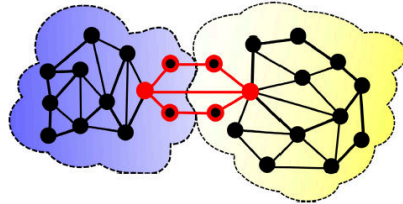
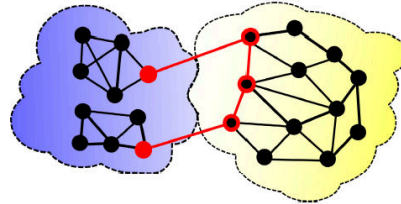

Fig. 8. Bridging by graph similarity



(a)



(b)

Fig. 7. Bridging graphs

Figure 2.1: Three examples of ways of bridging knowledge networks. Bridging concepts connect dense sub-graphs from different domains (Figure 6). Bridging graphs are sub-graphs that connect concepts from different domains (Figure 7). Bisociations based on graph similarity are represented by sub-graphs of two different domains that are structurally similar (Figure 8). (Kötter and Berthold 2012, 44-46)

2.3.6 Normal/Extraordinary Science, Vertical/Lateral Thinking, Arrière/Avant-garde

But Bisociation by any other name would smell as sweet. The philosopher of science, Thomas Kuhn, identifies a similar association/bisociation duality in the difference between *normal science* and *extraordinary science*.⁵ In *The Structure of Scientific Revolutions* (1996), Kuhn defines normal science in a way that seems to imply its associative nature, seeing it as the science which most scientists are doing day-to-day, in contrast to extraordinary science which is an infrequent, paradigm-shifting science that fundamentally changes the core principles of the field.

Normal science "research [is] firmly based upon one or more past scientific achievements, achievements that some particular scientific community acknowledges for a time as supplying the foundation for its further practice." (Kuhn 1996, 10)

No part of the aim of normal science is to call forth new sorts of phenomena; indeed those that will not fit the box [of the existing paradigm] are often not seen at all. Nor do scientists normally aim to invent new theories, and they are often intolerant of those invented by others. Instead normal-scientific research is directed to the articulation of those phenomena and theories that the paradigm already supplies.

(Kuhn 1996, 24)

Normal science, then has the primary function of strengthening existing causal links between elements in a network, rather than creating new networks of causality. We can see it as what Kuhn calls the "mopping-up work" that helps legitimate the existing paradigm, attempting to "force nature into the preformed and relatively inflexible box that the paradigm supplies." (Kuhn 1996, 24). It is science that treads the road most travelled.

In opposition to this, extraordinary science is that which involves the creation of new theories and the creation of a new paradigm, when "an anomaly comes to seem more than just another puzzle of normal science, the transition to crisis and to extraordinary science has begun." (Kuhn 1996, 82).

⁵The following is a modified version of the argument found in (Pocknee 2015b).

COMPARING TWO TWITTER NETWORKS

Although employees A and B follow approximately the same number of Twitter accounts, A's network is far more diverse than B's. For the most part, the people employee A follows are not following each other, which is more conducive to innovation and better idea generation. Compact Twitter networks like employee B's provide redundant information and are less conducive to ideation.

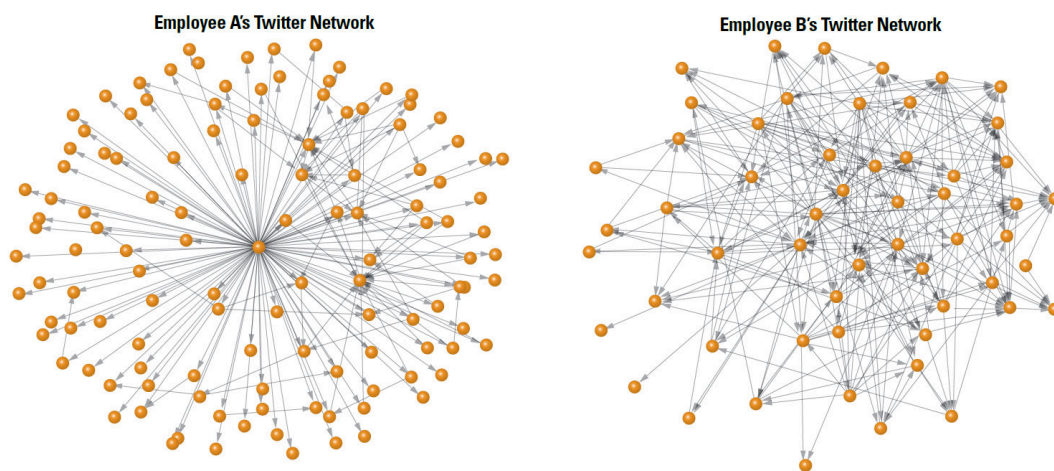

Figure 2.2: "In the diagrams, circles represent Twitter users, and an arrow from one user to another indicates that the first user is following the second user on Twitter. Even though both employees A and B follow approximately the same number of Twitter accounts, A's network is far more diverse than B's. That is to say, the people whom employee A follows on Twitter are, for the most part, not following each other. We can determine this level of diversity mathematically by using the compactness ratio, which measures the degree to which people in the network are connected to each other. For employee A, the network's compactness ratio is quite low, at 18%. Our research found that loose Twitter networks, such as employee A's, are better for ideation, because the potential for accessing a divergent set of ideas is greater. By contrast, employee B's Twitter network is compact: People in employee B's network mostly follow each other, resulting in a compactness ratio of 82%. Such cohesive networks provide more redundant information, which our research shows is negatively correlated with ideation." (Parise, Whelan, and Todd 2015, 22)

So, Kuhn contrasts the associative path-following nature of normal science to the pioneering bisociative spirit of extraordinary science, although he does not frame them in Koestler's terms. Similarly, we can think of bisociation as being a paradigm-shifting way of thinking, whereas associative thinking entrenches existing paradigms.

But extraordinary science by any other name would smell as sweet. The philosopher Edward de Bono proposed a vertical and lateral thinking duality that almost exactly mirrors Koestler's association/bisociation one. One sees in de Bono's concept of lateral thinking a similar idea of linking together previously unconnected ideas, stating that "[v]ertical thinking follows the most likely paths, lateral thinking explores the least likely" (Bono 1970, 42).

But lateral thinking by any other name would smell as sweet, and the progressive and regressive elements seen in Kosestler's, Kuhn's, and de Bono's typologies can also be found in the *avant-garde* of Henri Saint-Simon, and William Marx's *arrière-garde*. Avant-gardism is a paradigm-shifting form of knowledging similar to that found in extraordinary science, while arrière-gardism reinforces and attempts to legitimate an existing paradigm.

I use avant-garde in its original meaning, as coined by the Saint-Simonions in France in the beginning of the 19th Century. The term is used there with military connotations, referring to the group of troops in an army who were first in to battle, the "advanced guard" (Saint-Simon 1999, 120-121). It was first applied to artists in the essay *Opinions littéraires, philosophiques et industrielles* (1825) published by the circle of writers centring around the French socialist Henri Saint-Simon. In the article, it was claimed that artists, along with scientists and industrialists were the social groups who would drive society forward:

Where originally, under his earlier, more mechanistic philosophy, he had limited the role of artists merely to the positivistic end of popularizing ideas introduced by the scientists, now ... he places artists at the head of an administrative elite trinity consisting of artists, scientists, and industrial-artisans. In so doing, he gave rise to the conceptions both of an artistic avant-garde and of a social vanguard.

(Egbert 1970, 121)

Even if we just take the term "avant-garde" with its popular colloquial connotations, a clear parallel can be drawn between the normal/extraordinary science divide and that of the relationship between the avant-garde and its opposite, the arrière-garde:

As William Marx makes clear in the introduction to *Les arrière-gardes au xx^e siècle*, the concept of the avant-garde is inconceivable without its opposite. In military terms, the rear guard of the army is the part that protects and consolidates the troop movement in question; often the army's best generals are placed there. When an avant-garde movement is no longer a novelty, it is the role of the *arrière-garde* to complete its mission, to ensure its success.

(Perloff 2010, 53)

The progressive, paradigm-shifting nature of avant-gardism and the consolidatory aspects of arrière-gardism parallel the extraordinary/normal science duality.

2.3.7 Irrationality, Acausality and Epistemological Anarchism

When I was younger, I had an imaginary friend. Then I imagined the North Sea. And he drowned.

The joke above might provoke laughter. It is a bisociative *collision* of ideas, an acausal juxtaposition of two incompatible realities. Koestler saw bisociation as a key element in humour, as well as creativity.

Acausality and irrationality lies at the heart of bisociative thinking. We don't follow the obvious lines of connections in a network, we create new ones that branch across them. Bisociation is often acausal, undermining previously existing causal connections. Edward de Bono understood the often acausal and irrational nature of lateral thinking:

Lateral thinking is quite distinct from vertical thinking which is the traditional type of thinking. In vertical thinking one moves forward by sequential steps each of which must be

justified. The distinction between the two sorts of thinking is sharp. For instance in lateral thinking one uses information not for its own sake but for its effect. In lateral thinking one may have to be wrong at some stage in order to achieve a correct solution; in vertical thinking (logic or mathematics) this would be impossible. In lateral thinking one may deliberately seek out irrelevant information; in vertical thinking one selects out only what is relevant.

(Bono 1970, 11)

Cage's knowledging involved the seeking out of irrelevant information by using chance procedures to navigate the library . . . And what could be more irrelevant to 20th Century philosophers like Deleuze or Guattari than Seventeenth Century quilt-making? Shouldn't they be reading Kant? Instead, *A Thousand Plateaus* frequently exhibits a lateral/bisociative/extraordinary science approach to knowledging.

But lateral thinking by any other name would smell as sweet. The philosopher Paul Feyerabend argued against the view of the scientific method as a set of universally binding methodological rules, and instead proposed an approach premised upon the idea that the best methodology is to avoid developing a single position (Oberheim 2006, 220).

John Cage was famously an anarchist, a political view espoused most clearly in *Anarchy*, a book-length lecture of twenty mesostic poems based on the writings of anarchist thinkers (Cage 2001).⁶

It seems appropriate, then, to see Cage's knowledging as a form of *Epistemological Anarchism*, a term coined by Paul Feyerabend in his book *Against Method* (1984). Feyerabend sought to show that "famous episodes in science that are admired by scientists, philosophers and the common folk alike were not 'rational', they did not occur in a 'rational' manner, 'reason' was not the motivating force behind them, and they were not judged 'rationally'" (Feyerabend 1984, 13). In fact, Feyerabend goes further, not only proposing a new style of epistemology but actively dismantling the idea of the scientific method as a myth, claiming that:

The idea of a method that contains firm, unchanging, and absolutely binding principles for conducting the business of science meets considerable difficulty when confronted with the results of historical research. We find, then, that there is not a single rule, however plausible, and however firmly grounded in epistemology, that is not violated at some time or other. It becomes evident that such violations are not accidental events, they are not results of insufficient knowledge or of inattention which might have been avoided. On the contrary, we see that they are necessary for progress. Indeed, one of the most striking features of recent discussions in the history and philosophy of science is the realization that events and developments, such as the invention of atomism in antiquity, the Copernican Revolution, the rise of modern atomism (kinetic theory; dispersion theory; stereochemistry; quantum theory), the gradual emergence of the wave theory of light, occurred only because some thinkers either *decided* not to be bound by certain 'obvious' methodological rules, or because they *unwittingly broke* them.

(Feyerabend 2010, 7)

While Feyerabend did not share Cage's political convictions, stating that "anarchism, while not the most attractive political philosophy, is certainly excellent medicine for epistemology, and for the philosophy of science" (Feyerabend 1984, 1), anarchism's principles of a non-hierarchical system formed the basis for his conception of epistemological anarchism, first articulated in Chapter 16 of *Against Method*. In anarchy, Feyerabend saw a mirror of the scientific process, proclaiming that "[s]cience is an essentially anarchic enterprise: theoretical anarchism is much more humanitarian and more likely to encourage progress than its law-and-order alternatives" (Feyerabend 2010, 1), and most famously "if a rationalist were looking for a single, overarching, and unanimously adhered-to methodology that led scientific practice, they would find only one: 'anything goes'" (Feyerabend 2010, 7)

Given that the idea of epistemological anarchism idea exists only in the first edition of his book and was excised from all three subsequent editions, I quote Feyerabend's description here almost in its entirety:⁷

⁶This section is adapted from (Pocknee 2015b).

⁷Hacking notes that "significant extemporizations of Feyerabend's idea of Epistemological Anarchism (in Chapter 16 of *Against Method*) were excised from the second edition of the text (1988), as well as the removal of the subtitle 'Outlines of an anarchistic* theory of knowledge'" (Hacking, I. in Feyerabend 2010, xiii), wondering perhaps this is due to Feyerabend's

Arthur Koestler	Bisociation	Association
Edward de Bono	Lateral Thinking	Vertical Thinking
Paul Feyerabend	Epistemological Anarchism	The Scientific Method
Thomas Kuhn	Extraordinary Science	Normal Science
Henri Saint-Simon/ William Marx	Avant-garde	Arrière-garde

Table 2.1: Different types of knowledging

Epistemological anarchism differs both from scepticism and from political (religious) anarchism. While the sceptic either regards every view as equally good, or as equally bad, or desists from making such judgements altogether, the epistemological anarchist has no compunction to defend the most trite, or the most outrageous statement. While the political or the religious anarchist wants to remove a certain form of life, the epistemological anarchist may want to defend it, for he has no everlasting loyalty to, and no everlasting aversion against, any institution or any ideology. Like the Dadaist, whom he resembles much more than he resembles the political anarchist, he ‘not only has no programme, [he is] against all programmes’ though he will on occasions be the most vociferous defender of the status quo, or of his opponents: ‘to be a true Dadaist, one must also be an anti-Dadaist’. His aims remain stable, or change as a result of argument, or of boredom, or of a conversion experience, or to impress a mistress, and so on. Given some aim, he may try to approach it with the help of organized groups, or alone; he may use reason, emotion, ridicule, an ‘attitude of serious concern’ and whatever other means have been invented by humans to get the better of their fellow men. *His favourite pastime is to confuse rationalists by inventing compelling reasons for unreasonable doctrines.*⁸ There is no view, however, ‘absurd’ or ‘immoral’, he refuses to consider or to act upon, and no method is regarded as indispensable. The one thing he opposes positively and absolutely are universal standards, universal laws, universal ideas such as ‘Truth’, ‘Reason’, ‘Justice’, ‘Love’ and the behaviour they bring along, though he does not deny that it is often good policy to act as if such laws (such standards, such ideas) existed, and as if he believed in them.

(Feyerabend 1984, 189-190)

The idea of epistemological anarchism arises directly out of the observation that the process of science and the creation of knowledge is not a "rational" endeavour and does not proceed by a singular methodology, yet it need not be seen, as it often is, as a nihilistic critique of scientific positivism (Feyerabend 1982). Instead, we can use this as a blueprint for knowledging.

2.3.8 Typologies of Thinking

And yet, in the literature, we see a split overandover, between the ordered hypotheses-testing of the scientific method and something weirder, more random - but not an 80s revival of Snow’s *Two Cultures* or the *Science Wars* of Sokal, but a split in the very process of research itself, given as many names as the winged-one (see Table 2.1).

And perhaps even more could be added there, such as *Swanson’s linking*, based on "the assumption that new knowledge and insight may be discovered by connecting knowledge sources which are thought to be previously unrelated", an approach which has led to the creation of the fields of *literature-related discovery* and *conceptual biology* (Dubitzky et al. 2012, 28).

Or perhaps we could see Cage not as an anarchist, but as a Bayesian, creating a type of work based on *Bayesian Inference*, in contrast to the "classical" statistical model. A Bayesian model is "concerned with the consequences of modifying our previous beliefs as a result of receiving new data". Instead of the classical approach "which begins with a hypothesis test that proposes a specific value for an unknown

wish that "having read [Against Method] the reader will remember me as a flippant Dadaist and not as a serious anarchist." (Feyerabend 2010, xiv).

⁸My emphasis, see the entirety of this thesis.

parameter, θ , Bayesian inference proposes a prior distribution (often simply called a prior), $p(\theta)$, for this parameter" (Upton and Cook 2016). Perhaps one could read his experimental approach to composing as a type of aesthetic inference.

2.3.9 The Bisociative/Associative Handshake

As Kuhn describes, paradigm shifts occur via extraordinary science (which is of a bisociative nature) and involve a fundamentally re-thinking of the nature of the field. This is then followed by a consolidation procedure in which the new paradigm fights for supremacy and is eventually consolidated through the associative process of normal science. We could describe this changing over from one technique of knowledging to another as a *bisociative/associative handshake*. I believe the process of PhD research can follow a similar path, first the utilization of chance and randomness to create an *encounter* which can be the site of bisociative thinking. This introduction of acausality and irrationality into the research process encourages the researcher to construct new linkages within the bisociation network with minimal redundancy. This is then transformed into a "construction of truth" not just through the declaration of love via a reference list, but also through the use of associative thinking to consolidate this randomness, acausality and irrationality using the causality and rationality of conventional research.

This "handshake" provides the basis for the way in which the conclusion to this thesis is written - bisociation consolidated by association, both methods working in tandem. This is described further in Chapter 5.

2.3.10 Music Can Cure Cancer

The composer Andy Ingamells would, when I would become overly insistent on the importance of music during a conversation, would proclaim: "It's only music, it's not going to cure cancer!"

Well, I believe that music can cure cancer, so screw you, Andy.

Music need not vampirically leech off the hard work of other disciplines nor embrace scientism to shore up its declining relevance. Instead, it can adopt a bisociative/avant-garde/extraordinary science/lateral thinking/epistemological anarchistic approach. It can reduce its redundancy and become part of the bisociation networks of other disciplines. Music can be a type of knowledging. It can generate new knowledge.

But what use can music be to the world? It can't change it, only make pretty sounds and stuff. Well, consider the *harmony search algorithm*, a "metaheuristic population-based algorithm, mimicking the musical improvisation process where a group of musicians play the pitches of their musical instruments together seeking a pleasing harmony" (Al-Betar and Khader 2012, 3), and which has been in increasingly wide use since 2000 for tasks such as optimal timetable calculation for universities (Al-Betar and Khader 2012, 3), designs of municipal water distribution networks and pipe diameters, architectural structural design, soil stability, data clustering, transport and thermal/energy applications (Ingram and Zhang 2009) (see the book *Music-Inspired Harmony Search Algorithm: Theory and Applications* (Geem 2009)). But we can go further ...

On 17 October 2025, a young cancer researcher named Toni Chaubekada went to a concert of experimental music. This in itself was not unusual. The first two works on the programme struggled to hold their attention; one took its inspiration from the physics of black holes, the other retrod musical and conceptual ideas that they'd seen hundreds of times before, and Toni found their attention wandering back to the lab they had just come from, where another day had been spent failing to successfully prevent the spread of cancer in lymph node cells. Then the third piece started, and it was somewhere when the violins and plastic cups started interacting from across the room and a bone-shaking chord erupted from the ensemble, that suddenly the solution became clear - there, in the interactions between the players and that sound was the perfect mechanism for allowing those cells the protection that they needed ...

(Droppe 2032, 88)

2.4 Hypotheses For An Original Contribution To Knowledge

The philosopher Timothy Morton wrote a set of helpful blogposts on being a PhD researcher (<http://ecologywithoutnature.blogspot.co.uk/p/phd-advive.html>) (Morton 2011). In the second of them he claims that the aim of a PhD is to transform you from a student into a world expert in *something*.

If you are a composer, when you start your PhD you are *already* a world expert in your own work, as you are the one who makes it and very few other people care. If, at the end of a PhD, you are *still* only a world expert in your own work, then doing the PhD seems like a waste of time.

But perhaps bisociation can help - we can use the ideas about knowledging outlined earlier to construct new knowledge and become a world expert in ideas that had not existed previously, rather than the usual approach of relying on associative knowledging procedures to link to concepts which already exist.

Given the preceding descriptions of bisociative knowledging procedures, we can now propose four hypotheses for the writing of a music composition PhD Thesis:

Hypothesis 1 You can write a PhD thesis primarily using ideas from books/articles/references which are randomly chosen.

A PhD thesis in a creative field is a type of extraordinary science/avant-gardism and thus we can apply bisociative methods, which are better at generating new ideas than associative ones.

Hypothesis 2 The resulting piece of writing will make as much sense as a conventionally-referenced PhD thesis.

Knowledge is constructed socially, culturally and psychologically, and the knowledge that can be created from two unrelated pieces of information is premised not on their difference but on the creativity of the mind synthesizing them.

Hypothesis 3 If the corpus of books is large enough, it is highly likely that the random selection of references will result in juxtapositions (brushings) of information that have not occurred previously, thus creating a situation where an "original contribution to knowledge" is more likely than if using conventional research methodologies.

Hypothesis 4 If the corpus of books contains an equal amount of men and women, it is statistically likely that the reference list of your thesis will be gender-balanced. If the corpus is not gender-balanced, constraints can be placed on the random procedures to ensure this occurs.

Associative knowledging is causal and logical and, therefore, can only propagate existing power structures as the validity of logical inferences is always legitimized by these structures. As de Bono says "[w]ith lateral thinking one realizes that a pattern cannot be restructured from within itself but only as the result of some outside influence. So one welcomes outside influences for their provocative action. The more irrelevant such influences are the more chance there is of altering the established pattern. To look only for things that are relevant means perpetuating the current pattern." (Bono 1970, 41). Bisociative knowledging eschews causality, and thus allows a rupture with these constructions. Bisociative knowledging can provide an anarchistic denial of hierarchies of knowledge in the model of Paul Feyerabend's epistemological anarchism.

But how might one put into practice the hypotheses proposed above? What random procedures might be used to encourage bisociative thinking and generate an event-encounter? A survey of Cage's compositional methodologies points towards an answer - the use of divination techniques . . .

2.5 Types Of Divination

Divination is a set of techniques developed independently all over the world and at different periods that seek to reveal what is hidden, through irrational means (Karcher 1998, 215). Divination seeks not necessarily to "reveal the future", but to add to our normal intelligence by showing "what spiritual forces are active in your present situation and how you can successfully interact with them . . . The aim of divination is not to reveal an implacable future, but to place you in the process of that future, to connect you with the flow of life, through its signs symbols and spirits." (Karcher 1997, 10). It can fulfil

	Name	Attribute	Image	Family Relationship	
	Ch'ien	the Creative	strong	heaven	father
	K'un	the Receptive	devoted, yielding	earth	mother
	Chên	the Arousing	inciting movement	thunder	first son
	K'an	the Abysmal	dangerous	water	second son
	Kên	Keeping Still	resting	mountain	third son
	Sun	the Gentle	penetrating	wind, wood	first daughter
	Li	the Clinging	light-giving	fire	second daughter
	Tui	the Joyous	joyful	lake	third daughter

(a) The eight trigrams used in the *I Ching*. Two of these are combined to produce a hexagram.

TRIGRAMS	Ch'ien	Chên	K'an	Kên	K'un	Sun	Li	Tui
UPPER ▶								
LOWER ▼								
Ch'ien	1	34	5	26	11	9	14	43
Chên	25	51	3	27	24	42	21	17
K'an	6	40	29	4	7	59	64	47
Kên	33	62	39	52	15	53	56	31
K'un	12	16	8	23	2	20	35	45
Sun	44	32	48	18	46	57	50	28
Li	13	55	63	22	36	37	30	49
Tui	10	54	60	41	19	61	38	58

Key for Identifying the Hexagrams

(b) Table of all 64 hexagrams, numbered.

Figure 2.3: Diagrams from the third edition of the Wilhelm/Baynes translation of the *I Ching* (Wilhelm 1968).

a number of different functions: "It can give you information about the way your fate or inner spirit is moving, locate you in a process of transformation, give you "signs of the time" that connect events in your life with events in the world." (Karcher 1997, 10)

Divination appears in two different forms:

The world of divination can be divided into those procedures called "oionistic", which are based on calm reflection, and those called "mantic", requiring a passion, an ecstasy, to be "taken out of oneself". It was Plato who made this distinction. The oionistic procedures are like science itself; the astrologer or consulter of bones and entrails carefully investigates patterns. In contrast the shaman or prophet lets the gods speak through him or her, as unobstructed by personality as possible.

(Spiegelman 1998, 94)

Consultation of the *I Ching*, or Chinese *Book of Changes*, is an oionistic procedure. In a consultation, the randomness inherent in a coin flip or picking up of yarrow branches is used to give a numerical value which references a literal grid of 64 possible outcomes (see Figure 2.3b), defined by the combinatoric potential of the binary states of six broken or unbroken lines in each hexagram $2^6 = 64$.

One of the characteristically oionistic aspects of this process is the use of a highly ordered symbolic system (in this case the 64 hexagrams) (see Figure 2.3), which is then applied onto "random" or "chance" phenomena (the coin tosses), and meaning extracted from "reading" the way in which this symbolic grid is activated (this is done through the use of the *Commentaries*). In other words, the combinatoric, grid structure of the *I Ching* provides the quantization procedure through which the chaos of the world is interpreted and made sense of. Jungian psychologist Marie von Franz describes this as the interaction between an "order pattern" and a "random pattern" (Franz 1980, 45).

In contrast, mantic divination does not feature an "order pattern", instead using direct interpretation without the intermediary of a grid. von Franz does not use Plato/Spiegelman's terminology of oionistic and mantic divination, but instead splits divinatory techniques into numerical and non-numerical types, although these categories are, in practice, equivalent to Spiegelman's. For instance, here is her discussion of non-number divination techniques, which clearly correlates to mantic divination in Spiegelman's typology:

There are innumerable divination techniques which to my mind are techniques to catalyze one's own unconscious knowledge. These do not use number, but some chaotic pattern; still

much used among white men are tea leaves and coffee grounds, but you can use any other such pattern. . . .

. . . Almost all non-number divination techniques are based on some kind of chaotic pattern, which is exactly like the Rorschach test. One stares at a chaotic pattern and then gets a fantasy, and the complete disorder in the pattern confuses one's conscious mind.

(Franz 1980, 38-39)

Despite the lack of agreement over the names to be given to these two types of divinatory procedures, the descriptions by these different authors clearly point to the same structural differences in the techniques. Given the lack of consensus over nomenclature,⁹ how rarely both typologies are used outside the two author's writings, and the orientation of this thesis, I shall from now on use the term *quantized* to refer to oionistic/numerical techniques in which a "grid" or order-pattern is imposed over randomness, and *unquantized* to refer to mantic/non-numerical techniques in which no grid is involved and the interpretation comes unmediated from the interpreter.

2.6 Cage and Quantized Divination (Oionistic/Numerical)

And need we more hagiographic pages of Cage-praise? More trees to the altar please! Sacrificed for his chance methods, so overinkprinted. But I aim not for gag-inducing sycophancy, but to ground his work in those ancient histories of divination in a connection much undertalked.

Cage had used randomness and chance in compositions since the early 1950s in works such as *Imaginary Landscape No. 4* (1951) and *Music Of Changes* (1951-52). The way he generated chance in these works was through a divinatory procedure using the Chinese oracle, the *I Ching* or *Book of Changes*, a technique which, according to Pritchett and Dinwiddie's descriptions, was also used for his random book selections at UC Davis (Pritchett 1996).

While Cage's use of the *I Ching* oracle clearly divinatory, much of his other work often relied on procedures which mimicked (intentionally or not) types of divination. Some of the earliest examples are the *Sixteen Dances* (1951) and *Concerto for Prepared Piano and Orchestra* (1951) in which Magic Squares were used; these squares were also used for divination in China, where they could be used as "talismans that could attract and focus the energy of specific gods." (Karcher 1997, 116)¹⁰

For *Music of Changes* not only was the *I Ching* consulted, but the Tarot was dealt to determine durations, leaving Revill to remark "It is interesting to note that Cage used another oracular resource rather than a secular pack of cards. He never used the Tarot again, however . . ." (Revill 1992, 134)

His works *Atlas Eclipticalis* (1961), *Etudes Australes* (1974-75) *Etudes Borealis* (1978-79) and *Music for Carillon No. 4* (1961) all use star maps to choose their notes and mirror astrological consultations of the heavens, a connection which is further reinforced by the fact that Cage consulted astrologer called Julie Winter (this is mentioned briefly in a discussion about macrobiotic food in (Kostelanetz 1988, 28-29)). Perhaps more tenuously, the process behind his *Music for Piano* (1952-56) series, in which random imperfections in the paper are transformed into notes is similar to the process of oracular geomancy, a system which consists of 16 signs that were traditionally produced by making and counting random marks made with a wooden rod in a box filled with earth or sand, but are now commonly made upon a piece of paper (Karcher 1997, 118-122).

However, Cage's use of the *I Ching* was not as an oracle, but as an extremely inefficient random number generator,¹¹ using the numerical values of the hexagrams but none of the interpretive information

⁹I have also seen the following description for these two types: "Analytical thinkers have tended to break divination into two categories, ecstatic and inductive, or inner vision and outer thinking." (Karcher 1997, 16) One could also think of how this might mirror the Apollonian/Dionysian division embodied, perhaps by Cage and his *bête noire* Jackson Pollock - "Cage, argues [Earle] Brown is the Apollonian *par excellence*" (Revill 1992, 171); or that between what Cage refers to as "Chance operations" vs "Indeterminacy" (Revill 1992, 74).

¹⁰The most famous of these is the *Lo Shou* 3x3 arrangement (4 9 2 / 3 5 7 / 8 1 6) (Franz 1980).

¹¹Cage's description of his coin flipping procedure in *Silence* indicates that he followed the traditional way of consulting the oracle, which requires 3 coin flips per line, resulting in 18 flips per six-lined hexagram. However, this is only mathematically necessary if you are using the movable lines, which he was not. Without the movable lines, an *I Ching* hexagram is just an alternative representation of a binary string, meaning that you could generate a number between 1 and 64 by flipping one coin per line, reducing the work by a factor of 3 to only 6 flips per hexagram.

contained in the commentaries that would make them meaningful - a bit like going to a doctor and only taking the prescription without listening to their diagnosis. And then using the prescription slip as wallpaper:

[INTERVIEWER:] *You use the I Ching to make choices in composition. Is this use of it separate from the book's guiding or spiritual purposes?*

[CAGE:] Yes. It's not entirely separate from it, but I don't make use of the wisdom aspects in the writing of music or the writing of texts. I use it simply as a kind of computer, as a facility. If I have some question that requires a wise answer, then of course I use it that way. On occasion I do. But if I want to know which sound of one hundred sounds I'm to use, then I use it just as a computer.

[INTERVIEWER:] *Is this considered an improper use of the book?*

[CAGE:] By some people, I think, who are superstitious about it.

- (Kostelanetz 1988, 219)

In fact, Cage went against the traditional Chinese way of approaching the book, that suggests only to consult the oracle with a specific question. In his writing, Jung comments that "[a]n unknown question is followed by an unintelligible answer." (Jung 1985, 50) However, Cage performed consultations without specific questions in mind and, in fact, stockpiled consultations, as he pointed out in another interview: "And this box over here that has ropes around it is full of *I Ching* printouts. So I have a great supply of answers to questions which I have not yet asked." (Kostelanetz 1988, 18)

In many ways, Cage's frequent use of adapted quantized divination techniques in his works make sense, as this is very much in line with his compositional methodology. Just as quantized divination involves the imposition of an interpretive grid over random phenomena in order to transform this phenomena into a prognostication about the state of reality, Cage uses the same procedure to perform a similar transformation of randomness into art.

I will use both quantized and unquantized divination techniques as knowledging procedures for writing the Conclusion of this thesis. Cage's random selection of library books at UC Davis is easy to replicate and use as a way of generating a bisociation network for the Conclusion. This is explained in Chapter 5 and implemented in the Conclusion.

2.7 Unquantized Divination (Mantic/Non-numerical)

Cage's divination process for choosing library books involved the consultation of the *I Ching*. The *I Ching* is a quantized divination process but there are also unquantized divination methods for generating an encounter . . .

2.7.1 The Psychogeography of Knowledge

When my hands held b/w warmcopies in outshuffle through the pagewalled labyrinth of university library to stairwell exit and from eyecorners scream they, like hardcore sirens in oldleafs from lowerfloors and dustcovered dustcovers, of *Women Who Kill* or *Killing For Company* then how could I but rockwrecked skinpeel and snapspine for their grimness that the bookplanners could not guess; but for chance and the topology of their kingdom I now know, and in pastyears when Malcolm Gladwell would mirrorwander by his own instinct then how could he but rockwrecked thumbsplit other fronts as axeheavy as his redcover paperback now lining another charityshopped geography (see Figure 2.4)that I could not but rockwrecked tipback that frontleaf to find him;

...in 1996, I came to write my first signed article for the *New Yorker*. It was an attempt to explain the drop in crime in New York city. It was called "The Tipping Point."

It is an odd thing, to think back on the genesis of that article, because it was so *random* - as the teenagers say. In my boredom in those days, I used to go to Bobst Library at New York University and wander through the stacks. This was the 1990s, of course when a library was still just a place full of things written on paper. I was leafing through the back issues of the *American Journal of Sociology* and came across an article by Jonathon Crane called "The Epidemic Theory of Ghettos." I wasn't looking for it. I was standing in the aisle - HM1 .A7 - and just plucked out a volume, in the hope that lightning might strike. And it did.

- Malcolm Gladwell, *The Tipping Point* (2013), in *Introduction to the 2013 Edition*.

and as the space and the cost and the ease and the knownot burybreathing our bookbrothers in serverstacks and distantdisks glance shielded and prisonchainlinked to keep us railed to the causal and its network of so many spiderchains to web us down in growing knownot or singleknows and libraries so shelfempty we now no longer cloudwander in such pageladen hills so hemmed by their holders of stone and brick and wood that to oneeighty is so majorswitched to otherface a that which could not be guessed from its infacing carriagecousin

Principles of Psychogeography

... the map's format - grids of orthogonal lines peppered with indications of rivers, capitals, and such - ... originated in the Greco-Roman culture of inquiry, exploration and conquest ... But it was Eratosthenes (276-196 BCE), the head of the most renowned library of the ancient world at Alexandria, who would develop the hard science around the Greek philosophers' cartographic model.

(Higgins 2009, 81-82)

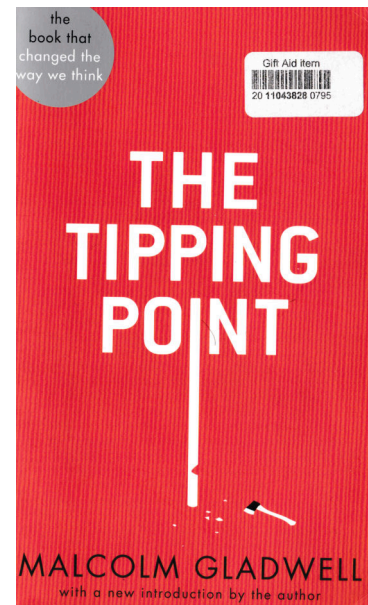

Figure 2.4: Front cover of my copy of the 2013 edition of Malcolm Gladwell's *Tipping Point* found during a *dérive* in the Oxfam second-hand bookstore in Huddersfield in 2016. Could this be some sort of recursive *dérive*?

We could see Gladwell's purposeless wondering around Bobst library as a type of psychogeographic *dérive*, a type of aimless wandering around a man-made environment. Psychogeography is an idea proposed by the Situationist group of artists/activist/philosophers in the 1950s. According to a 1958 definition, it is "The study of the specific effects of the geographical environment, consciously organised or not, on the emotions and behaviour of individuals." (Ford 2005, 34)

Psychogeography was seen as a blend of psychology and geography, looking at the psychological effects of urban environments. As a part of this exploratory approach to city navigation, the principle of a *dérive* was created, as a methodology to aid this exploration.

In a *dérive* one or more persons during a certain period drop their usual motives for movement and action, their relations, their work and leisure activities, and let themselves be drawn by the attractions of the terrain and the encounters they find there.

-Guy Debord *Theory of the Dérive* (quoted in (Ford 2005, 34))

A *dérive* need not simply be an unstructured walk, one of the most famous examples of a *dérive* involved a more strict methodology in which a friend of Debord wandered through the Harz region of Germany while blindly following the directions of a map of London (Coverley 2006, 91).¹²

In these more structured methods, we see once again the power to create an *encounter* through the bisociation of two unrelated things: the region of Harz and the map of London. The situationists Guy Debord and Gil J. Wolman saw the *dérive* as originating in a combination of chance and planning - although Debord was eager to ensure that this chance didn't arise from habit or automatism, which he believed was creatively exhausted by the surrealists (Sadler 1999, 78), a position which mirrors Cage's statement that "[a]utomatic art, in fact, has never interested me, because it is a way of falling back, resting on one's memories and feelings subconsciously, is it not? And I have done my utmost to free people from that." (Kostelanetz 1988, 173)

Gladwell is unknowingly participating in a psychogeographic type of unquantized divination. In some ways, the library provides a more suitable and inclusive situation for the practice of the inherently white male nature of the *dérive*. Only this subset of the population can traverse a city in a way that sees architecture as the primary constraints upon geography and not the violence of race and gender.¹³ In the more controlled environment of the library, some of these issues are dissipated, hopefully giving a more inclusive space to practice these psychogeographic principles.¹⁴

The Power of Physical Libraries

A library is not just a physical manifestation of information. Libraries which exist in the physical (as opposed to digital) world play an important function because the environment they create is conducive to the process of bisociation.

¹²Later, more sophisticated processes were developed, such as the Algorithmic Psychogeography practiced by the Dutch group *Social Fiction*, who would navigate the city using a series of iterative directions, such as:

2nd right
2nd right
1st left repeat.
(Bek 2002)

¹³It is worth noting that one of the first psychogeographic investigations, published in *International Situationiste #2*, was a piece of writing about a district in Paris entitled *Attempt at a Psychogeographical Description of Les Halles*. Its author, the Algerian national Abdelhafid Khatib, "was unable to complete his study of Les Halles due to repeated harassment from the police. North Africans were at this time subject to curfew and, after twice being arrested and spending the night in a cell, he was understandably reluctant to continue." (Coverley 2006, 99-100). Similarly, we could think of the problems that occur when black men play the pseudo-psychogeographic game *Pokémon Go* in the USA (see (Akil 2016)), or the restrictive safety concerns faced by female field-recorderists (see (Jones 2015)). Also see the article *Psychogeography and feminist methodology* (Bridger 2013); coincidentally, an article that I found whilst on a *dérive* in the library.

¹⁴In relation to the use of psychogeographic and divinatory procedures as knowledging apparatus to generate an encounter, there are three interesting fictional examples, all in the realm of detective fiction. *Zen Navigation* is a technique practised by Douglas Adam's "holistic detective" Dirk Gently and first proposed in *The Long Dark Teatime of the Soul* (Adams 1988): "My own strategy is to find a car, or the nearest equivalent, which looks as if it knows where it is going and follow it. I rarely end up where I was intending to go, but often I end up somewhere that I needed to be. So what do you say to that?" (Adams 1988, 153). Secondly, FBI Detective Dale Cooper in the third episode of the television show *Twin Peaks* uses the "Tibetan Method" for trying to determine the suspects of a murder case by throwing "rocks at a bottle situated on a tree stump-at a precisely measured distance-as the name of each suspect is read from the blackboard" (Nochimson 1992-1993, 24-25). Thirdly, the Existential Detectives in David O. Russell's film *I Heart Huckabees* use a barrage of unconventional, often Zen-inspired techniques in their investigations (Russell 2004).

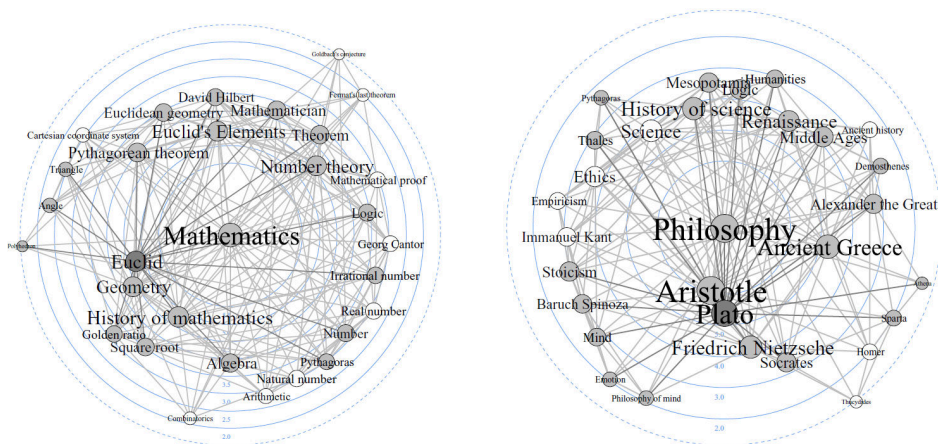

Figure 2.5: Visualisations of the Wikipedia-Schools entries for philosophy and mathematics (Berthold 2012, 5).

Now don't get me wrong, I love Wikipedia, I'm a real Wikipedophile, but it has its limitations. Wikipedia and other internet-based hubs of information are associative - they suggest *related* articles and link to pages of interest based upon their *causal* relationship to the page you are on. For instance, compare the networks in Figure 2.5, which show networks of Wikipedia-Schools entries (<http://schools-wikipedia.org/>), to the twitter diagrams shown in Figure 2.2 and notice the redundancy.

This is a problem which extends to the principles behind spotify, the recommended products on amazon.com, and the suggested videos on youtube.com. In fact the whole set-up of the world wide web is based on a linking system which privileges associative thinking and causal linkages. One of the most dangerous risks to bisociative thinking online, is the development of the *semantic web* and the associative causality it implies.

The bisociative possibilities of the web will die the moment google removes the "I'm Feeling Lucky" button from its search page.

The online world is based upon association, and therefore is not conducive to creating the environments needed for the *encounter*. Badiou understands this, which explains why he is so critical of online dating: "It is love comprehensively insured against all risks" (Badiou 2012, 6).¹⁵

A physical library allows for a psychogeographic *dérive*, a process which is acausal and is fertile ground for the creation of *encounters*. The same can be said for bookshops, and many of the ideas I have amassed over the years are the result of Badiou-ian encounters in these spaces.¹⁶

¹⁵In contrast to the web, one could see Big Data's approach as being a more bisociative methodology, in which correlation is privileged above causation. In fact, one might even make the claim that the Big Data approach is *synchronistic*, in the Jungian sense, especially when one compares it to the associative systems of neural networks.

¹⁶For example, I found the book *The Dice Man*, quoted in the first chapter, in an exhibition in London, which was a recreation of a teenage girls' room from the 1970s (*In My Room* by Aurelius Productions / Dorothy's Shoes at Spill Festival of Performance on 1 November 2015).

2.7.2 Reading As Psychogeography and Unquantized Divination

The Sortes

Mallarmé saw a poem as "chance defeated word by word".
(Badiou 2012, 45)

In the same way that one can psychogeographically walk through a library, one can similarly *dériver* through a book. Just as the movement through a space or architectural environment reveals something about the psychological state of the walker *and* the architectural priorities of a space, a movement through a book can do something similar.

There is a name for this type of oracle - *the sortes*:

This practice turns a book into a divinatory instrument and can yield surprising results. Originally, it used the Bible or Virgil's *Aeneid*, which Romans considered to be a holy book.

The practice survived for centuries, even though formally forbidden by the church.

The method is simple, though in some forms it involved ritual preparation. It consists of posing a question, opening the book you have chosen without looking, and putting your finger on the page. The word or phrase picked out at random is the answer the book gives to your question.

(Karcher 1997, 51)

A less directed version of this technique was used to choose many of the quotations from ancient Greek dramatists and Shakespeare found at the start of sections in this thesis using the following process:

1. Get a copy of the collected plays of ancient Greek dramatists and a copy of the collected works of Shakespeare.
2. Flip to a random page in one of these books.
3. Look for any quotation that is related to the current section you are writing about.
4. Place this quotations at the start of this section.

We can see Cage's library activity at UC Davis as an updated and expanded form of the *sortes*. Cage also used a directly-related technique in some of his later work, such as the imaginary *mise-en-scène* of *James Joyce*, *Marcel Duchamp*, *Erik Satie: An Alphabet* and the stage directions for the *Européras*, which were selected by chance from Webster's unabridged dictionary (Revill 1992, 283).

We could also use the *sortes* to increase a thesis-writers vocabulary and bisociate on the level of words?:

1. Take a dictionary, flip to a random page.
2. Write down any words that you do not know.
3. Use these in your writing.

A full list of dictionary words I have added into this thesis using this method can be found in Chapter 5. This is also a technique I used extensively in (Pocknee 2015a).

2.7.3 Mesostics

Cage also used his poetic form of the mesostic as a way of unpredictably moving through a text in a way which created new juxtapositions and bisociations:

During 1976 Elliot Anderson, who edited the journal *Tri-Quarterly* ... was preparing a special issue, *In the Wake of the "Wake"*, and asked Cage for some kind of contribution. ...

[Cage] opened *Finnegans Wake* at random - page 356 - and began writing mesostics using the name of Joyce as a string until he reached the end of the chapter. ...

"It was a discipline," he wrote, "similar to that of counterpoint in music with a cantus firmus."

(Revill 1992, 254)

But could a musical piece be a mesostic? In 2015 I wrote a work for solo piano entitled *A Beethoven Mesostic* (2015), inspired by Cage's poetic work and which I think is the world's first ever musical mesostic.

The basic principle behind a linguistic mesostic is taking a target-text and embedding it into the spine of the writing, similar to the way in which an acrostic will embed a target-text into the first letter of each line. An example of a mesostic can be seen in Figure 2.6, taken from one of his books of mesostics *Anarchy*. Here the target-text is the name of anarchist thinker Peter Kropotkin, arranged down the centre of the poem. This example also reveals an aspect of Cage's later mesostic writing, which is the use of found texts as the material for all of the writing. All of the text found in *Anarchy* is taken from writings by anarchist thinkers that are then collaged using the computer program *Mesolist* that Jim Rosenberg made for him.

In the *Finnegan's Wake* example at the top of the section, Cage starts at a random point in the book and, using James Joyce's name as a target-text, collages the sequential text of the book into a series of mesostics. This technique was then expanded out to encompass the entire book, moving through chronologically from the first page to the last, in his *Writing Through "Finnegans Wake"* (1976), "682 pages of mesostics extracted from top to bottom of the book" (Revell 1992, 254-255). This was a process Cage referred to as "writing-through" and which the poet Jackson Mac Low prefers to call a "reading-through text-selection procedure" (Low 2010, 220).

In many ways, this reading-through text-selection procedure is a form of divination, in which the interaction between an algorithm and the letter-distribution of the book creates a path through it. This is also similar to the algorithmic psychogeography mentioned in the last section.

A Beethoven Mesostic attempts something similar. Starting with a corpus of all 32 of Beethoven's Piano Sonatas, the piece uses an ascending, five-octave chromatic scale as a target-text and attempts to build this by collaging together fragments of Beethoven's sonatas. The work is created using an algorithm similar to Rosenberg's program. It could be described verbally as follows:

1. Order the Beethoven Sonatas sequentially from 1-32.
2. Start with a blank score, from here on referred to as the "mesostic score".
3. Start from the first bar of the first Beethoven sonata and move forward note-by-note searching for the first note of the ascending, five-octave chromatic scale (the G an octave below the lowest line of the bass clef).
4. When this note has been found, copy all of the music in the sonata that occurs during the duration of this note.
5. Paste the copied music into the beginning of the mesostic score.
6. Go back to the Beethoven sonata. Search forward note-by-note from the position directly after the end of the section of music that was copied, looking for the next note in the ascending scale.
7. When the note has been found, copy all of the music that occurs during the duration of this note.
8. Paste the copied music into the mesostic score, directly after the end of the last segment of music copied in.
9. Repeat instructions 6-8. If you reach the end of a sonata, start at the beginning of the next one. If you reach the end of the ascending scale, start back at the beginning, and keep looping until the end of the piece. The work ends when you reach the end of the 32nd sonata.

Break Down Of First Line Of "A Beethoven Mesostic"

The figure displays several musical excerpts from Beethoven's sonatas, with red boxes highlighting specific notes and fragments. These fragments are then used to form a central mesostic score. The excerpts include:

- G# - A - Sonata 2 - Allegro Vivace - bar 101
- Bb - Sonata 2 - Largo Appassionato - bar 61
- G - Sonata 1 - Adagio - bar 25
- B - Sonata 2 - Largo - bar 76
- C# - Sonata 3 - Allegro - bar 103
- C - Sonata 3 - Allegro - bar 13

Figure 2.7: An analysis of the opening few bars of *A Beethoven Mesostic* showing the original Beethoven sonata from which each fragment is taken from.

I
 sPirit of
 him for onE
 corporaTions
 arE
 failuRe
 Know-how of
 aRe
 idOlS will
 free rePublic
 each thrOUGH
 Them in
 maKe
 I
 to me
 aNarchism

Figure 2.6: An example of one of the mesostics from Cage's *Anarchy*, spelling out the name of anarchist thinker Peter Kropotkin (Cage 2001).

Figure 2.7 shows this process in action at the very opening of the piece. Around the page are the actual sections of music from the Beethoven sonatas that were copied to make the mesostic in the centre. What is noticeable is that not all of the notes are copied from each section. This is due to a coding error with the program (mid2asc.exe) which I used to translate MIDI data of the sonatas into more easily manipulable text data which my Lisp algorithm could operate upon. Although this was not the original intention of the work, I feel that enough of Beethoven's style is still audible through this process and that the missing notes allow a transparency to the harmony of the work that aids creating continuity between each collaged section.

Interestingly, I tried this process upon a whole range of historical keyboard works by different composers from different eras and it was only the work of Beethoven which generated interesting results. I think part of the reason for this is that Beethoven's style lies somewhere between the more strict voice-leading of the Classical period and the extended harmony of the Romantic period. With the "target text" being an ascending chromatic scale, this means that there is always an embedded chromatic movement through each collaged section, which can then function in Beethoven's musical language as leading-tones which harmonically connect the sections and provide harmonic movement that not only gives the work a pacing and harmonic tension/resolution that would otherwise be lacking but accomplishes that in a way which is stylistically appropriate to the material, with the rhythmic irregularities and lack of conventional phrase structure creating a counterbalance that accentuates the oddity of the musical mesostic procedure.

Selfhelplessness and Cipher for the Lighthouse Twins

In my book *Selfhelplessness*, the psychological state of the reader is both laid bare and manipulated. The book borrows the form of a "choose-your-own-adventure" book, popular in children's literature and, instead, subverts it by replacing the fun adventure narratives typical of this genre with very adult self-help questions.¹⁷

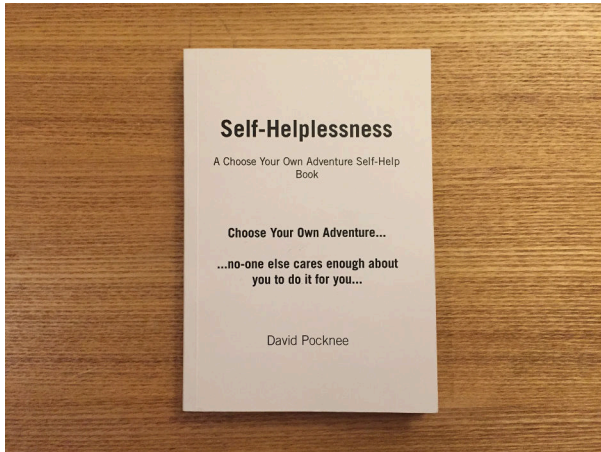

Figure 2.8: Image of *Selfhelplessness*

Q: So there's some type of structure involved?

A: Yes, the work is conceived such that every question is a point on a 10x10 grid, with the questions on each row being based around a rough subject of the type you would expect to find in a self-help book. Answering "yes" moves you horizontally along the grid and answering "no" moves you vertically. In each subsequent column, the number of rows up you move when answering "no" increases (see Figure 2.10).

Q: Why bother doing this if there are no answers?

A: It helps the book appear to act like it is responding to your questions; if you answer "yes" to a question on a particular subject, it will ask you more about that subject, if you answer "no", it will change the subject.

Q: But looking at the book, this 10x10 structure isn't apparent ...

A: The 10x10 grid doesn't appear in the book in this order, the pages were randomly scrambled to disguise this underlying structure so the reader doesn't realize they are being manipulated in this way.

Q: But this still doesn't seem to fully explain why the book is as depressing as it is.

Q: Yeezus, this book is depressing!

A: It's designed that way.

Q: How?

A: Firstly, there are no answers. In contrast to normal self-help books which try to help the reader by directing them towards active solutions, all of the questions in this book lead to every other question.

Q: So, you could potentially be stuck reading it forever without getting any answers?

A: The book is 100 pages long. If you answered "yes" to every question, you would go through every question in the book once before you ended up in the same place, and the same would happen if you answered "no" to every question.

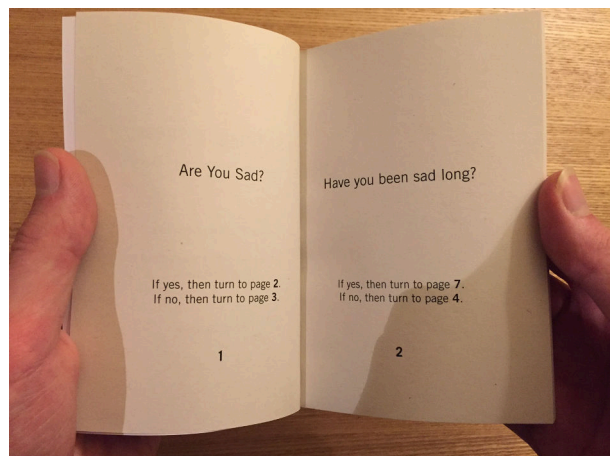

Figure 2.9: Image of *Selfhelplessness*

¹⁷"This type of work is also referred to as 'ergodic literature' by Espen Aarseth, a type of writing ... in which 'nontrivial effort is required to allow the reader to traverse the text'. In ergodic literature, 'the experienced sequence of signs does not emerge in a fixed, predetermined order decided by the instigator of the work, but is instead one actualization among many potential routes within what we may call the event space of semio-logical possibility'." (**hayot-ergodic**)

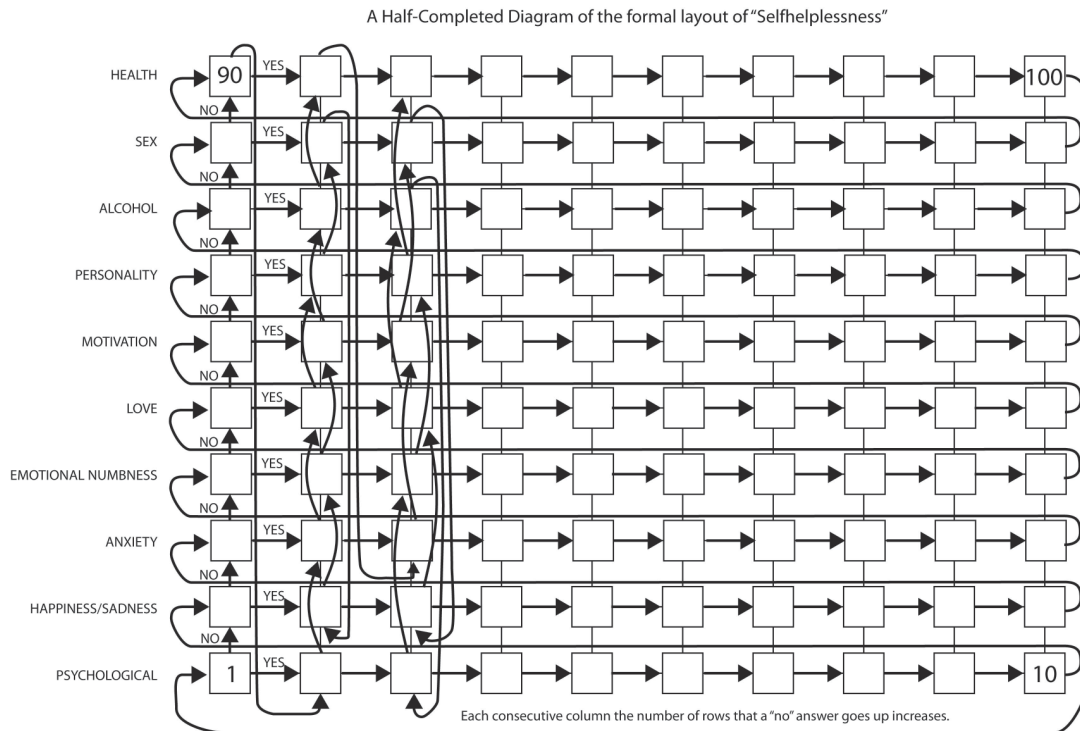

Figure 2.10: Diagram showing the structure of *Selfhelplessness*. The diagram is only partially completed for the sake of clarity.

A: The way in which language is used also helps. I'm doing what in Neuro Linguistic Programming is referred to as "reframing" (O'Connor and Seymour 2002), where I word questions to accentuate negative aspects. As a simple example, I would ask you "Are you sad?" rather than "Are you happy?" to put a negative spin on the question.

Q: This is a book. Is this composition?

A: As I mentioned at the start of this thesis, I see composition as a lineage of tools, not as a sound-specific way of working.

Q: What tools does this draw from, then?

A: I think the highly-formalized nature of the structure, the element of randomizing pages and the "indeterminate in relation to performance" approach to its realization are all quite characteristic of mid-century compositional modernism.

Q: But this also mirrors some kind of messed-up divinatory procedure, where the grid of the book is imposed onto the chaos of the reader's mind?

A: I think you can see elements of the way in which von Franz and Jung talk about the ability of divination to reveal hidden unconscious processes. "Coincidence, as understood through Jung's concept of synchronicity, is a phenomenon in which the self confronts an important aspect of its own nature" (Verene 2002, 459)

Q: And it's somehow psychogeographical?

A: Imagine that the choice between two answers on each page is like a fork in a road.

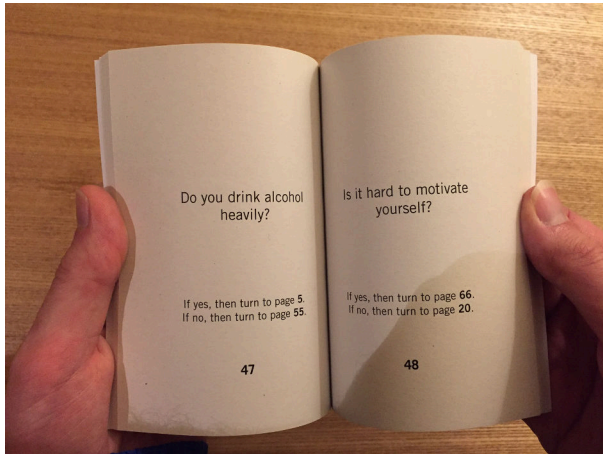

Figure 2.11: Image of *Selfhelplessness*

Q: Jung's idea of synchronicity seems important, especially in relation to Cage and bisociation.

A: Well, Jung wrote the foreword to the edition of the *I Ching* that Cage used (the Bollinger edition with the Wilhelm and Cary Baynes translation (Hamm 1997, 288)) and it was here that Jung first laid out his ideas about synchronicity, "a concept that formulates a point of view directly opposed to that of causality. Since the latter is merely statistical truth and not absolute, it is a sort of working hypothesis about how events evolve out of one another, whereas synchronicity takes the coincidence of events in space and time as meaning something more than mere chance, namely a peculiar interdependence of objective events among themselves as well as with the subjective (psychic) states of the observer or observers." (Wilhelm 1968, xxiv)

Q: Synchronicity seems related to bisociation, especially given that Jung refers to synchronicity as "an acausal connecting principle", which seems is what bisociation seeks to do (Jung 1985).

A: You could conceive it as a description of the *encounter*. Perhaps not a description of how it works, but of its existence although here it originates not *just* in chance because in Jung's analysis, chance becomes meaningful.

Q: Your other book work Cipher for the Lighthouse Twins, for two readers, doesn't seem to reveal anything about the psychic state of the reader, however?

A: This work is almost pure process. Two readers face each other, each with a copy of the same book. Each page of the book is unique and has four options of whether to flip the current page one or two pages forward or backwards according to the pages flipped by the other reader. The piece involves them taking it in turn to flip a page in reaction to how the other reader flipped.

The readers basically function as random number generators and the piece starts with them flipping to a random page in the book. After that, however, you are simply watching the interaction of the books themselves - there is no self-expression on the part of the reader, they are simply the conduit for the ordering systems built into the books.

Q: Do the performers not have the ability to make any decisions?

A: No.

Q: So the performers have no agency?

A: Exactly, but do we really have any agency in life? Are we not simply articulating a set of social, cultural, psychological, physical and biological systems much larger than ourselves?

Q: So this is some sort of strange propaganda for philosophical determinism, then?

A: I realized recently that so much of my work is just that - pieces which seem open, but in which the performers have no agency - just like being alive! Open works are only open if you believe that humans have agency.

Q: But if we have no agency and all is determined, then the future can be predicted!

A: This is why divinatory oracles work.

Q: Denmark's a prison

A: Then is the world one.

*Now shall mine oracle no more look forth
Out of a dim veil like new-wedded bride,
But put on a brightness as a wind that blows
Towards the sun's uprising, 'gainst the light*
- Aeschylus *Agamemnon* (Aeschylus 1952, 64)

Chapter 2 Bibliography

- Adams, Douglas. 1988. *The Long Dark Teatime of the Soul*. London: William Heinemann.
- Aeschylus. 1952. "Agamemnon." In *Great Books of the Western World: 5 Aeschylus Sophocles Eurides Aristophanes*, ed. by Robert Maynard Hutchins, 52–69. London: William Benton.
- Akil, Omari. 2016. "Warning: Pokemon GO is a Death Sentence if you are a Black Man." <https://medium.com/mobile-lifestyle/warning-pokemon-go-is-a-death-sentence-if-you-are-a-black-man-acacb4bdae7f#.308k11n9x>.
- Badiou, Alain. 2012. *In Praise of Love*. London: Serpent's Tail.
- Baxter, Mike. 1995. *Product Design: A practical guide to systematic methods of new product development*. London: CRC Press.
- Bek, Wilfried Hou Je. 2002. "Algorithmic Psychogeography." <http://www.spacehijackers.org/html/ideas/writing/socialfiction.html>.
- Berthold, Michael R. 2012. "Towards Bisociative Knowledge Discovery." In *Bisociative Knowledge Discovery*, ed. by Michael R. Berthold, 1–10. Heidelberg: Springer.
- Al-Betar, Mohammed Azmi, and Ahamad Tajudin Khader. 2012. "A harmony search algorithm for university course timetabling." *Annals of Operations Research* 134 (1): 3–31.
- Bono, Edward de. 1970. *Lateral Thinking*. London: Penguin.
- Brassier, Ray. 2014. "Unfree Improvisation/Compulsive Freedom." *Grafter's Quarterly* 1:2.
- Bridger, Alexander John. 2013. "Psychogeography and feminist methodology." *Feminism and Psychology* 23 (3): 285–298.
- Burr, Vivien. 2003. *Social Constructionism*. London: Routledge.
- Cage, John. 2001. *Anarchy*. Middletown, CT: Wesleyan University Press.
- . 1976. *For The Birds*. Boston/London: Marion Boyars.
- Coverley, Merlin. 2006. *Psychogeography*. Harpenden: Pocket Essentials.
- Deleuze, Gilles, and Félix Guattari. 2004. *A Thousand Plateaus*. London: Continuum Books.
- Dinwiddie, John. 2011. "Mewantemooseicday." In *Source: Music of the Avant-Garde, 1966-1973*, ed. by Larry Austin and Douglas Kahn, 235–238. Berkeley: University of California Press.
- Droppe, Frederick. 2032. *The Sidewinder Sleeps Tonight: Scientific Discoveries of the Early 21st Century (2000-2030)*. Chicago: University of Chicago Press.
- Dubitzky, Werner, et al. 2012. "Towards Creative Information Exploration Based on Koestler's Concept of Bisociation." In *Bisociative Knowledge Discovery*, ed. by Michael R. Berthold, 11–32. Heidelberg: Springer.
- Egbert, Donald Drew. 1970. *Social Radicalism and the Arts: Western Europe*. New York: Knopf.
- Feyerabend, Paul. 1984. *Against Method*. 4th ed. London: Verso.
- . 2010. *Against Method*. 1st ed. London: Verso.
- . 1982. *Science In A Free Society*. London: Verso.
- Ford, Simon. 2005. *The Situationist International: A User's Guide*. London: Black Dog Publishing.
- Franz, Marie-Louis von. 1980. *On Divination and Synchronicity*. Toronto: Inner City Book.

- Geem, Zong Woo, ed. 2009. *Music-Inspired Harmony Search Algorithm: Theory and Applications*. Berlin: Springer.
- Gladwell, Malcolm. 2013. *The Tipping Point*. London: Abacus.
- Hamm, Charles. 1997. "Privileging th Moment: Cage, Jung, Synchronicity and Postmodernism." *The Journal of Musicology* 15 (2): 278–29.
- Higgins, Hannah B. 2009. *The Grid Book*. Massachusetts: MIT Press.
- Huddersfield, University of. 2016. *Regulations for Awards*. Twenty-second revision. Huddersfield: University of Huddersfield.
- Ingram, Gordan, and Tonghua Zhang. 2009. "Overview of Applications and Developments in the Harmony Search Algorithm." In *Music-Inspired Harmony Search Algorithm*, ed. by Zong Woo Geem, 15–38. Berlin: Springer.
- Jones, Lucy. 2015. "Natural Imbalance: The Threat to Female Field-Recorders." <http://pitchfork.com/thepitch/962-natural-imbalance-the-threat-to-female-field-recorders/>.
- Jung, Carl. 1985. *Synchronicity: An Acausal Connecting Principle*. London: Arc.
- Karcher, Stephen. 1998. "Divination, Synchronicity and Fate." *Journal of Religion and Health* 37 (3): 215–228.
- . 1997. *The Illustrated Encyclopaedia of Divination*. Shaftesbury: Element Books.
- Koestler, Arthur. 1964. *The Act of Creation*. London: Penguin.
- Kostelanetz, Richard. 1988. *Conversing With Cage*. New York: Limelight Editions.
- . 1993. "The Anarchist Art of John Cage." <http://sterneck.net/john-cage/kostelanetz/index.php>.
- Kötter, Tobias, and Michael R. Berthold. 2012. "From Information Networks to Bisociative Information Networks." In *Bisociative Knowledge Discovery*, ed. by Michael R. Berthold, 33–50. London: Springer.
- Kuhn, Thomas. 1996. *The Structure of Scientific Revolutions*. London: The University of Chicago Press.
- Lewis, Ricki. 2009. *Discovery: Windows of the Life Sciences*. Hoboken, NJ: Wiley-Blackwell.
- Low, Jackson Mac. 2010. "Cage's Writings up to the Late 1980s." In *Writings through John Cage's Music, Poetry and Art*, ed. by Christopher Hatch and David W. Bernstein, 210–233. Chicago: University of Chicago Press.
- Mcluhan, Marshall. n.d. "The Agenbite of Outwit." http://projects.chass.utoronto.ca/mcluhan-studies/v1_iss2/1_2art6.htm.
- Morton, Timothy. 2011. "Ecology Without Nature." <http://ecologywithoutnature.blogspot.co.uk/p/phd-advive.html>.
- Neimeyer, Robert A. 1995. "An Invitation to Constructive Psychotherapies." In *Constructivism in Psychotherapy*, ed. by Robert A. Neimeyer and Michael J. Mahoney, 1–8. Washington: American Psychological Association.
- Nicholls, David. 2007. *John Cage*. Illinois: University of Illinois.
- Nochimson, Martha. 1992-1993. "Desire under the Douglas Firs Entering the Body of Reality "Twin Peaks"." *Film Quarterly* 46 (2): 22–34.
- Noddings, Nel. 1995. "Constructivism in Mathematics Education." In *Journal for Research in Mathematics Education: Monograph Number 4 - Constructivist Views on the Teaching and Learning of Mathematics*. Ed. by Robert B. Davis, Carolyn A. Maher, and Nel Noddings, 7–18. Reston, Virginia: National Council of Teachers of Mathematics.
- Oberheim, Eric. 2006. *Feyerabend's Philosophy*. Berlin: Walter de Gruyter.
- O'Connor, Joseph, and John Seymour. 2002. *Introducing NLP*. London: Element.
- Parise, Salvatore, Eoin Whelan, and Steve Todd. 2015. "How Twitter Users Can Generate Better Ideas." *MIT Sloane Management Review* 56 (4): 21–25.
- Perloff, Marjorie. 2010. *Unoriginal Genius*. London: University of Chicago Press.

- Pocknee, David. 2015a. "An Experimodern Coda to Human Sexuality." http://cerenem.ricercata.org/articles/human_sexuality/page01.html.
- . 2016. "Composer Advice." <http://www.twitter.com/composeradvice>.
- . 2015b. "Composition Is Not A Jaffa Cake, Research Is Not A Biscuit: A Riposte to John Croft." http://davidpocknee.ricercata.org/writing/croft-essay_airline_version_03.pdf.
- Pritchett, James. 1996. *The Music of John Cage*. Cambridge: Cambridge University Press.
- Revill, David. 1992. *The Roaring Silence: John Cage: A Life*. London: Bloomsbury.
- Roozenburg, N.F. M., and J. Ekels. 1995. *Product Design: Fundamentals and Methods*. New York: John Wiley & Sons.
- Rule, Alix, and David Levine. 2013. "International Art English." https://www.canopycanopycanopy.com/contents/international_art_english.
- Russell, David O. 2004. *I Heart Huckabees*.
- Sadler, Simon. 1999. *The Situationist City*. London: MIT Press.
- Saint-Simon, Henri de. 1999. "Opinions litteraires, philosophiques et industrielles." In *Art and It's Histories: A Reader*, ed. by Steve Edwards, 188–189. Guilford: Open University.
- Small, Christopher. 1998. *Musicking*. Middletown, CT: Wesleyan University Press.
- Concise Oxford English Dictionary*. 2009. Ed. by Catherine Soanes and Angus Stevenson. Oxford: Oxford University Press.
- Spiegelman, J. Marvin. 1998. "The Scientific and Mythological basis of divination." *Psychological Perspectives: A Quarterly Journal of Jungian Thought* 37 (1): 92–107.
- Sword, Helen. 2012. "Zombie Nouns." http://opinionator.blogs.nytimes.com/2012/07/23/zombie-nouns/?_r=0.
- Upton, Graham, and Ian Cook. 2016. "Bayesian Inference." In *A Dictionary of Statistics*. Oxford: Oxford University Press.
- Verene, Donald Phillip. 2002. "Coincidence, historical repetition and self-knowledge: Jung, Vico and Joyce." *Journal of Analytical Psychology* 47:459–478.
- Wilhelm, Richard. 1968. *The I Ching or Book of Changes*. London: Routledge / Kegan Paul Ltd.

Chapter 3

Completism

*A prologue armed, but not in confidence
Of author's pen, or actor's voice, but suited
In like conditions as our argument
- Shakespeare Troilus and Cressida*

3.1 About Completism

Completism is a new word for an old phenomenon.

It's been there undersurface-lurking, nametagsmudged and cornerbottle-partyhunched into backgroundfiller. Yet there. And now petri-grown from footnotes, dual-birthered by Siamese mothers: myself and Beavan Flanagan¹ - a name that bawls its own history.

Someone once said that punk died the moment the first kid exclaimed that punk wasn't dead. And so, in the light-flickered green of the deliveryroom, we as midwives deliver to the world only the viscera-soaked scrawl of a suicide note.

This is no plan for the future, not a manifesto or an "ism" spasm'd into being, but a form of archaeology: we show you what has been hidden below the shifting sands of aesthetic fashion for the last 60 years.

And you've seen them - the "catalogue pieces", these exercises in exhaustion: you've dragged the ant-roasting focus of your cynosure across the canvas that offers "every single combination of..."; sat in darkhalls richter-scale rocked by the aftershocks of muffled coughs as musicians slowly unfold "every possible permutation of..."; paused from tab-switched distraction in the lull between clickclusters, swapping skytinged realities to watch the realization of "all possible x in ..."; axeheavy spinesplit another book to read "every single element of x alphabetically re-ordered"; seen the theatre stage as photocopier for "the whole of x copied verbatim"; seen movement air-inscribed by dancer's hand cutting through the black-boxed void as they enact "every single x transformed into y "; heard loudspeakers spatter "the entirety of...". You already *know* completism ...

Completism already exists. It was on the tip of everyone's tongue; Tyler and I just gave it a name (Fincher 1999). Poets, playwrights, composers, painters: every discipline had its completists and hardly anybody noticed.²

Since the late 1950s, artists in visual art, music, theatre, literature, dance, poetry and net art have used the mathematical field of combinatorics to create artworks. Completism is where discrete mathematics meets creativity, where artists such as Sol LeWitt, Anne McGuire and Kenneth Goldsmith use permutation, combination, enumeration, mapping, re-ordering and direct transcription to create new works. Completism crosses genres and generations.

With the increasing growth and popularisation of completist ways of thinking, especially in the realm of net art, now is an ideal time to try and piece together this previously neglected history. From Brion

¹This chapter is a modified and condensed version of sections of a book on completism that I am writing with Beavan Flanagan. Although we have worked together formulating the ideas behind this subject and collecting the pieces found in the list at the end of this chapter, all of the following research and writing that follows is my own.

²A notable exception is Janet Zweig in her *Ars Combinatoria* article (Zweig 1997).

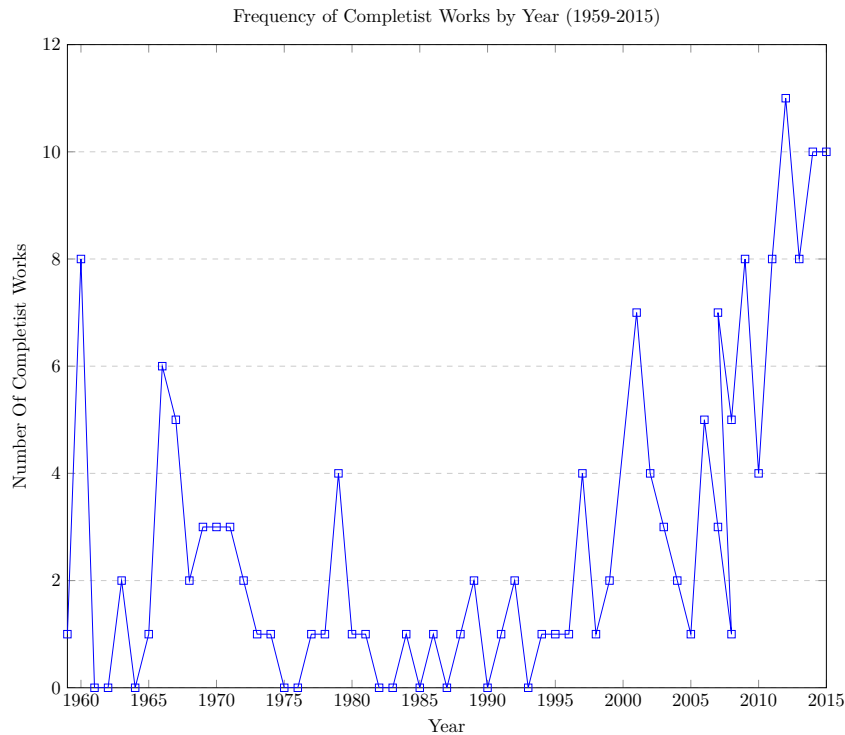

Figure 3.1: Graph showing the yearly frequency of completist works in our corpus.

Gysin's earliest *Permutation Poems* to youtube "Supercuts", this way of thinking spans over 60 years and multiple artistic disciplines. This chapter presents a new analytical framework for combinatoric artmaking.

Completism starts with Brion Gysin in 1958. Because good stories don't fade in. There are earlier examples, like Cristoph Graupner's *Canon with 5626 inversions* (1730-35), or the English "change ringing" tradition, or Pingala's *Chandasastra* which systematically explores the combinatorial possibilities of short and long syllables in Sanskrit, but completism only starts to move from the time-speckling of historical oddities to the close-clustering of a zeitgeist following the invention of the computer language FORTRAN in 1956. And as computers have become smaller and cheaper and easier to use, completism has grown (see Figure 3.1).

And so we collected - what else were we meant to do?

Myself and Beavan built a corpus of completist works from 1958 to the present day. A corpus of 120 different works. This corpus can be found at the end of this chapter and has been visualized in Figure 3.1. The works in the corpus come from a wide range of artistic disciplines: music, visual art, photography, dance, theatre, literature, poetry and net-art. Each work was only included if it met a strict set of criteria, based upon the following definition:

A completist work consists, almost solely, of the systematic exhaustion of specific combinatorial possibilities, iterated once only, of the subsets (and/or their relations) of a fixed and finite set of discrete elements.

This definition will be explained and further elaborated at the end of this chapter. Within this definition, completism can then be broken down into six separate sub-categories: permutation, combination, enumeration, re-ordering mapping, and direct transcription, which form the structure of the rest of this chapter.

3.2 Permutation

*Of author's pen, A prologue armed,
but not in confidence
In like conditions as our argument
but suited or actor's voice,
- Shakespeare Troilus and Cressida*

3.2.1 The Permuted Poems of Brion Gysin

It's 1959, and the poem *I AM THAT I AM* by the visual artist, poet and sound art pioneer, Brion Gysin kick-starts completism (see Figure 3.2).

I AM THAT I AM is the first of Gysin's collection of *Permutation Poems*, all of which feature the systematic process of working through all possible permutations of a set of words given in the title of the poem. In this case, the title used is the *Divine Tautology* found in Aldous Huxley's book *The Doors Of Perception* (Gysin 2001, 79).

You pick up a new pack of cards - still cellophane-sealed - and thumbnail-dig along the plastic edge to find that loosewrap purchase-point, pulling to emerge the box from its transparent cocoon. You lidpick and cardshake its contents into a neat palmpile and deftly fanspread them face-up on the greenbaize tabletop. Their newborn-order as expected: suit-separated, numerical succession, kissingkings and all. You upscoop them back, handstacked, and then shuffle: a simple cut and riffle-shuffle will do. You again deftly fanspread them face-up on the greenbaize tabletop to find that newborn-order now world-corrupted, the randomness of your hands so deranging that beautiful patterning. You have permuted the deck of cards. Shuffling a deck of cards creates a permutation of its order.

A permutation is a re-ordering of a set of elements or, in mathematical terms, a bijective mapping of a finite set onto itself (Matoušek & Nešetřil 1998, 52). It is also sometimes referred to as a shuffling or derangement of elements. In contrast to *combinations* of a set, a permutation always involves a re-ordering of *all* elements of the set, without the addition or subtraction of any member. This is in contrast to *combinations*, which need not involve all members of the set.

Permutation and Combination:

Let us take a set containing 4 elements: {1,2,3,4}

Some of the possible *permutations* of this set are:

{1,2,4,3}

{3,4,1,2}

{4,3,2,1}

Some of the possible *combinations* of this set are:

{1,2,3}

{2}

{3,1,1,2,4,4,4}

The number of possible permutations of a given set is found by calculating the factorial of its number of members. The factorial (notated $n!$) is the product of all natural numbers lower than and equal to n :

$$n! = n(n-1) \times \dots \times 2 \times 1 = \prod_{j=0}^{n-1} (n-j) = \prod_{i=1}^n i.$$

(Matoušek & Nešetřil, 1998 p.54)

For example, the ordered set $\{a, b, c, d\}$ contains 4 members. Therefore, the factorial of 4 ($4!$) gives the total number of possible permutations of this set:

$$4! = 4 \times 3 \times 2 \times 1 = 24$$

This can be proved through listing all of these:

$\{a, b, c, d\}$	$\{a, b, d, c\}$	$\{a, c, b, d\}$	$\{a, c, d, b\}$	$\{a, d, b, c\}$	$\{a, d, c, b\}$
$\{b, a, c, d\}$	$\{b, a, d, c\}$	$\{b, c, a, d\}$	$\{b, c, d, a\}$	$\{b, d, a, c\}$	$\{b, d, c, a\}$
$\{c, a, b, d\}$	$\{c, a, d, b\}$	$\{c, b, a, d\}$	$\{c, b, d, a\}$	$\{c, d, a, b\}$	$\{c, d, b, a\}$
$\{d, a, b, c\}$	$\{d, a, c, b\}$	$\{d, b, a, c\}$	$\{d, b, c, a\}$	$\{d, c, a, b\}$	$\{d, c, b, a\}$

The number of possible permutations of a given set increases exponentially in relation to its number of members:

$1! = 1$	$4! = 24$	$7! = 5,040$	$10! = 3,628,800$
$2! = 2$	$5! = 120$	$8! = 40,320$	$11! = 39,916,800$
$3! = 6$	$6! = 720$	$9! = 362,880$	$12! = 479,001,600$ ³

The title of Gysin's poem *I AM THAT I AM* (Figure 3.2) contains five elements $\{I, AM, THAT, I, AM\}$, so there are $5! = 120$ possible permutations of this title, meaning that Gysin's poem will be 120 lines long, as none of these permutations are repeated.

I AM THAT I AM
 AM I THAT I AM
 I THAT AM I AM
 THAT I AM I AM
 AM THAT I I AM
 THAT AM I I AM
 I AM I THAT AM
 AM I I THAT AM
 I I AM THAT AM
 I I AM THAT AM
 AM I I THAT AM
 I AM I THAT AM
 I THAT I AM AM
 THAT I I AM AM
 I I THAT AM AM
 I I THAT AM AM
 THAT I I AM AM
 I THAT I AM AM
 AM THAT I I AM
 THAT AM I I AM

Figure 3.2: Extract of the first twenty lines of Brion Gysin's *I AM THAT I AM* (Gysin 2001, 80)

Gysin's permutation poems are not only some of the oldest versions of completist poetry, but some of the earliest versions of completist works in any discipline, an especially ironic fact given Gysin's much repeated claim that "[w]riting is fifty years behind painting" (Gysin 2003, 154-155).

The narrative of *I AM THAT I AM* is the narrative of a single systematic process. Nothing else happens in the work. There is an input (the title), and then the algorithm takes over, re-arranging it, deranging it, until the redundancy of repetition causes it to stop. In completism you listen very carefully, for they shall say this only once. Each permutation of the title is iterated once, and once only.

Gysin wrote a series of these permutation poems between 1958 and 1960, such as *JUNK IS NO GOOD BABY*, *KICK THAT HABIT MAN*, *NO POETS DONT OWN WORDS* and *I DONT WORK YOU DIG*, all based on identical principles of titular permutation. Many of these were broadcast in 1960 as part of a BBC Radio programme called *The Permuted Poems of Brion Gysin* (Gysin 2001, 79).⁴

Gysin understood two ideas that would become key features of completism:

1. That the same, simple, combinatoric processes can be applied to work across multiple artistic disciplines
2. That a computer can be used to aid in the execution of these combinatoric processes.

³This is the number of possible twelve-tone rows.

⁴Although they were only published in print many years later, in works such as *Let the Mice In* (1973) or *The Third Mind* (1978).



Figure 3.3: Extract of *Overture*

The development of completism in the twentieth and twenty-first century has been driven by developments in computing. Gysin's collaborator: the artist, mathematician and programmer, Ian Sommerville generated many of the complete versions of Gysin's permutation poems on a computer, with some of these realizations being used for the BBC broadcast. Sommerville was a mathematics student at the University of Cambridge and wrote the program on punch cards for the Honeywell 200/120 computer: "The input was a string ("sentence") whose n elements ("words") were separated by spaces...[Gysin's] stated intention: To refrain from adding any external meaning to the result – the permuted text was supposed to disclose its sense on its own." (Bajohr 2014) This program printed all of the permutations in a logical order based upon the process it had used to calculate them, and included any semantic redundancies resulting from the duplication of elements.

e.g. if 1=I, 2=AM, 3=THAT, 4=I, and 5=AM; then the ordering:
 $\{1,4,2,3,5\} = \{I,I,AM,THAT,AM\}$ produces the same result as
 $\{4,1,5,3,2\} = \{I,I,AM,THAT,AM\}$ even though the permutation of elements is different.

For the aforementioned BBC broadcast, Gysin also took the permutation ideas from his poetry and applied them to recorded sound to produce an early work of sound art: *Pistol Poem* (1960):

In this piece, a single pistol shot was recorded on tape and then rerecorded, he has explained, "as heard from the distance of one yard, two yards, three yards, four yards and five yards. The reports were run through their possible permutations and laid in sound layers with my voice speaking the numbers.

- Brion Gysin describing *Pistol Piece* (Gysin 2001, 79)

This work is the earliest completist work of sound art. Gysin's savvy realization of the multidisciplinary potential of combinatoric processes foreshadowed the multidisciplinary nature of modern completism.

The start of my work *Overture* from *I Can Do Better* shares some similarities with *Pistol Poem*. There are five loudspeakers placed in a line on stage. My voice comes out of each speaker in turn, stating each speaker's number, in relation to its order on stage: "Speaker 1!", "Speaker 2!", "Speaker 3!", "Speaker 4!", "Speaker 5!". I then continue through as many permutations of these 5 speakers as possible in the piece's 3 minute duration. An even more extreme version of permutational thinking in my practice are the pieces *Plastic Cup Permutations* (Figure 3.5) and *Realization #2: Christian Wolff's "Stones"* (Figure 3.10). The second of these is part of a series of works in which I make concrete realizations of open text scores, each based on a previous performance I have done of the original.

Around the same time as Gysin's *Permutation Poems*, the poet, musician and fluxus participant, Emmett William's wrote one of the first modern completist works of music, his *Cellar Song for Five Voices* (1960), first published in *An Anthology of Chance Operations* (1963) (Young & Mac Low 1963,

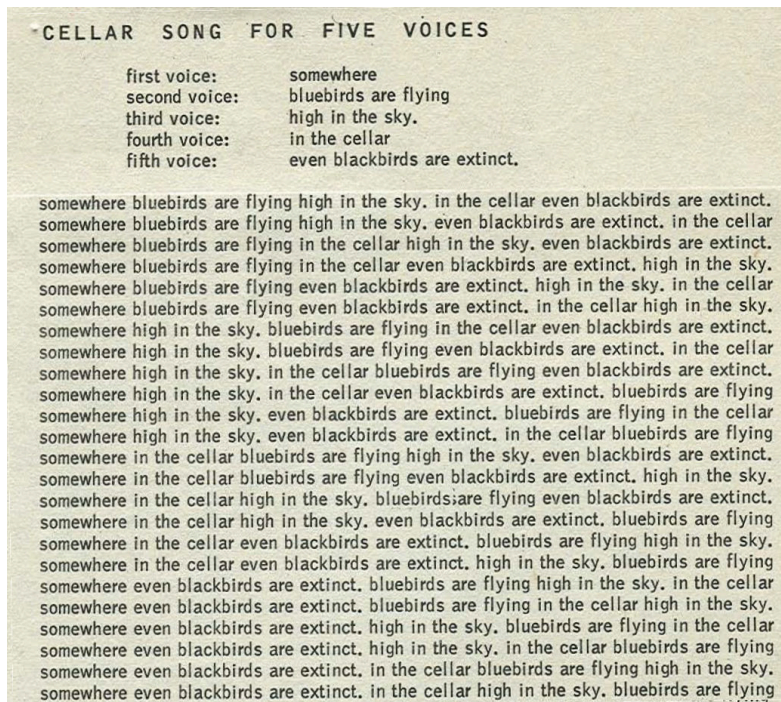

Figure 3.4: Extract of Emmett Williams *Cellar Song for Five Voices* (1963) from *An Anthology Of Chance Operations*

n.p). It consists of a permutation algorithm much like Gysin's, but here *groups* of words are permuted and each of these groups is executed by a different performer (see Figure 3.4).

A work clearly influenced by Williams is Jackson Mac Low's poem *JAIL BREAK* (1965) which similarly uses multiple performers to work through all permutations of a sentence (in this case, "Tear all jails down now") (Figure 3.9). Both of these works also have many similarities with Georg Perec's later radio play *The Machine* (1968), in which a short extract by Goethe is submitted to a variety of completist techniques displaced over four different "channels", or performers (Bellos 2012, 38). While William's work is titled a "song", the actual discipline it belongs to is debatable, especially given its inclusions in the *Anthology of Concrete Poetry* (1967) edited by Williams himself (Williams 2013).

In music, certain types of the English tradition of "change ringing" of church bells, (which has been in existence since at least the 18th Century), are based on permutational principles. In change ringing, each permutation is referred to as a "change", and an "extent" involves the full exhaustion of all permutational possibilities of the changes, without repeat (Intermont & Murphy 2011, 225).

Musical permutational works in most of the 20th Century, however, were few and far between, with the composer Tom Johnson furnishing two of the scarce examples: *Tango* (1984) (Figure 3.8) and *Music And Question* (1988), both of which use five-note permutative processes and terminate when all 120 orderings have been reached. Although permutational thinking pervades much of the set-theoretical thinking associated with Total Serialism, this is primarily used as a tool for material generation, and is hardly ever as systematic or foregrounded as it would need to be to classify as completist under our definition.

Plastic Cup Permutations

David Pocknee

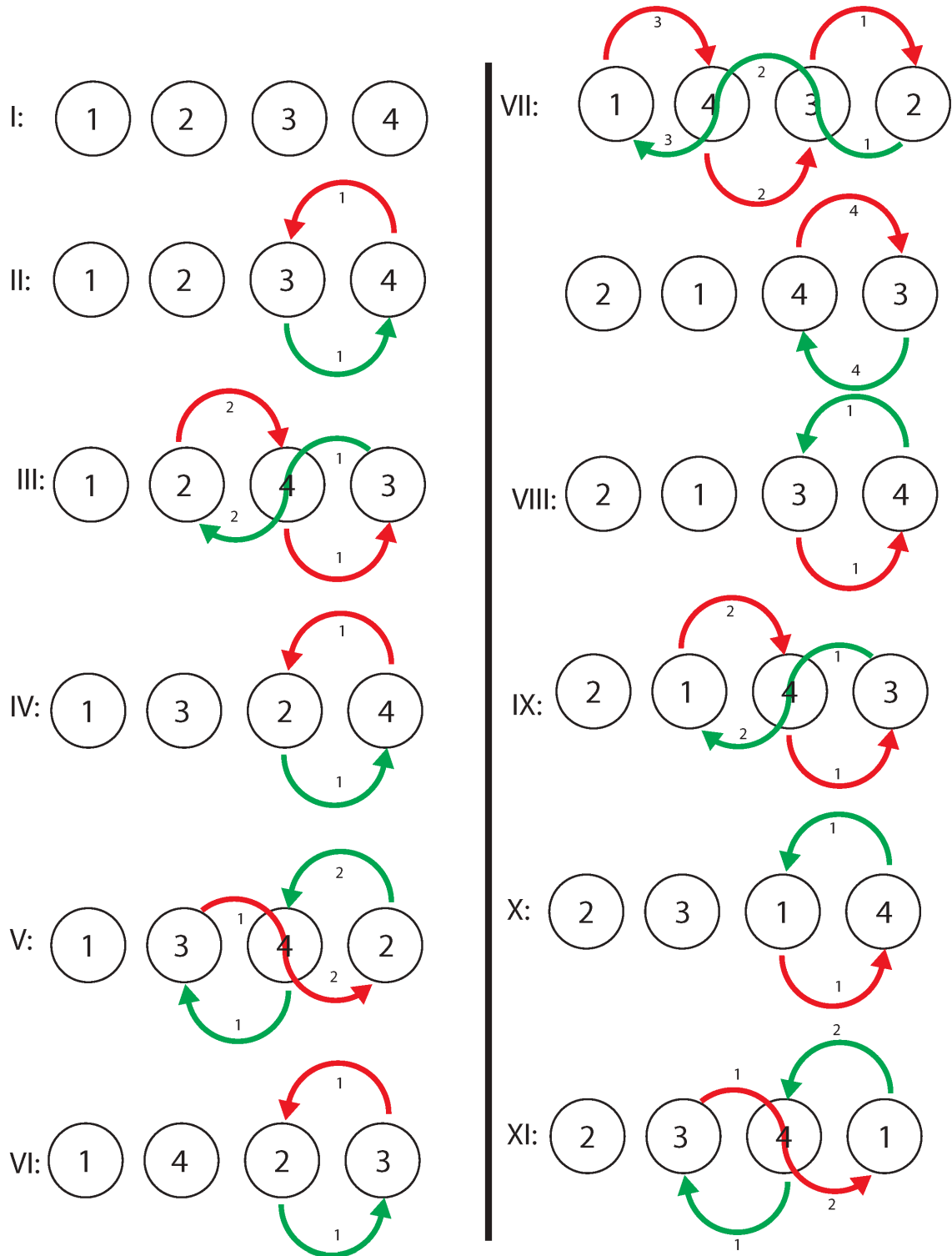

Figure 3.5: Page 1 of *Plastic Cup Permutations*

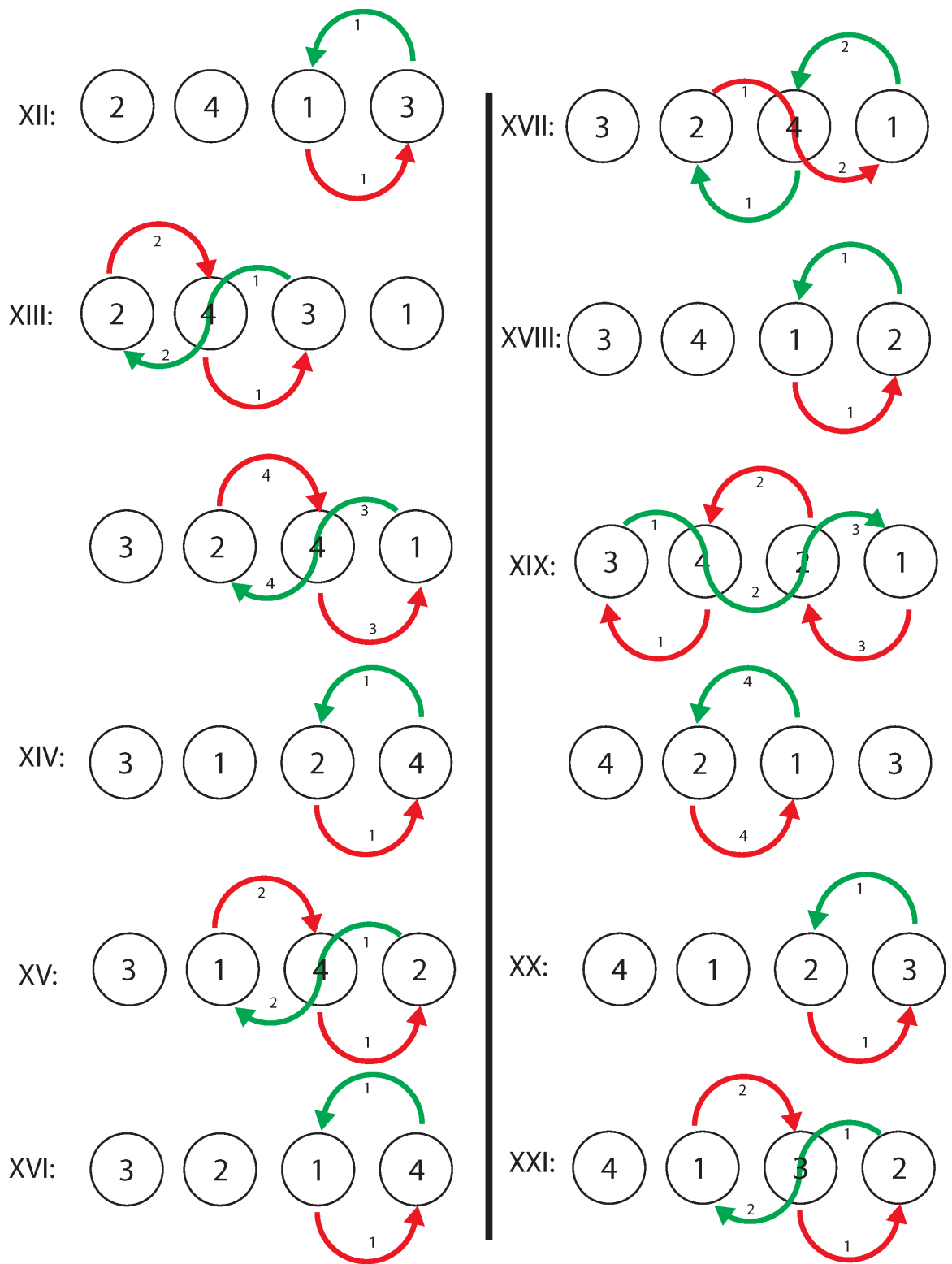
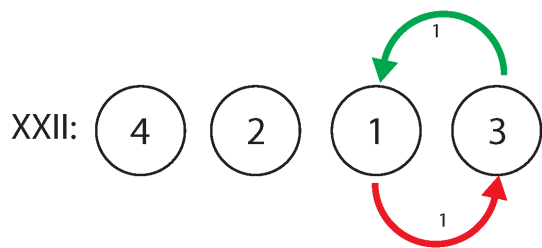

Figure 3.6: Page 2 of *Plastic Cup Permutations*



Instructions

This piece explores different arrangements of four plastic cups placed in a line.

The piece works through all 24 possible combinations that the cups can be placed in, whilst in a single line. and the score indicates how to move between each of these positions.

For the piece, the base of each of the four cups used should be numbered from 1-4.

For the performance, the cups should be placed on a small table, face down, in a line, with approximately 3cm between each one.

The score shows the position of all four cups, at their different positions during the piece with the coloured arrows indicating which cups should be moved at which time by which hand. The red arrow indicates movements of cups executed by the right hand, whilst the green indicates movements executed by the left.

The movement of the cups should be executed by sliding them over the surface of the table, following the path specified in the score. At no point should they lose contact with the table.

All of these movements should be performed as fast as possible, without sacrificing accuracy.

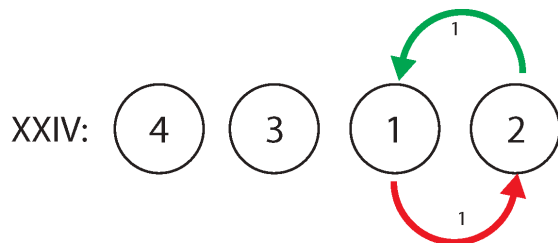
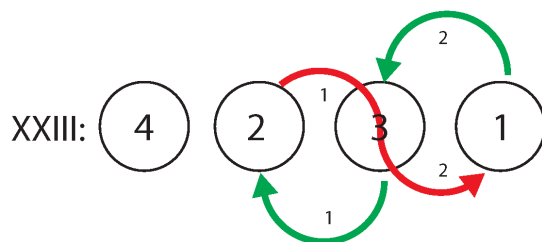

Possible Versions:

This piece can either be performed through once with plastic cups, or in an extended version using plastic and polystyrene cups. In the extended version, the piece is played through multiple times, starting with four polystyrene cups. At the end of each completion, one of the polystyrene cups should be swapped for a plastic one, according to the order on the left (pl = plastic cup, po = polystyrene).

Use of cups in the Extended Version. Each numbered line indicates what cups should be used for each cup in that repetition of the score:
Cup 1 / Cup 2 / Cup 3 / Cup 4

- | | |
|----------------------|-----------------------|
| 1: po / po / po / po | 9: po / pl / pl / po |
| 2: pl / po / po / po | 10: po / pl / po / pl |
| 3: po / pl / po / po | 11: po / po / pl / pl |
| 4: po / po / pl / po | 12: pl / pl / pl / po |
| 5: po / po / po / pl | 13: pl / pl / po / pl |
| 6: pl / pl / po / po | 14: pl / po / pl / pl |
| 7: pl / po / pl / po | 15: po / pl / pl / pl |
| 8: pl / po / po / pl | 16: pl / pl / pl / pl |

Each time a cup is moved, another cup must be moved simultaneously with it, so that each place in the line is empty for a minimal amount of time. The numbering of each coloured arrow is designed to show which actions should be occurring simultaneously. The movements should be performed in the order specified by the numbers.

After each movement has been performed, both hands should be briefly out of contact with the cups. Whilst moving between positions, a hand should be in contact with one of the cups throughout the entirety of the movement (the hand used may swap over the course of the movement, using moments where both hands are in contact as pivot points).

Where a longer line with several numbers is used, the smaller movements which occur along its length should be executed in order, with each smaller movement following directly on from its predecessor, while the longer gesture should be kept completely fluid, at a consistent speed.

Figure 3.7: Page 3 of *Plastic Cup Permutations*

The image displays a musical score for Tom Johnson's *Tango* (1984), specifically bars 3 through 18. The score is presented in two systems, each consisting of a grand staff with a treble clef and a bass clef. The key signature is one sharp (F#), and the time signature is 3/4. The melody in the treble clef is characterized by a rhythmic pattern of eighth notes, often beamed in pairs, with a consistent interval of a major second. The bass clef part provides a steady accompaniment, primarily using quarter notes and dotted quarter notes, with a consistent interval of a major second. The overall texture is simple and rhythmic, typical of a tango accompaniment.

Figure 3.8: Bars 3-18 of Tom Johnson's *Tango* (1984)

JAIL BREAK (for Emmett Williams & John Cage) September 1963, April & August 1966

Tear now jails down all.	All jails now down tear.	Jails tear down all now.
Tear all now down jails.	All now tear down jails.	Jails tear down now all.
Tear now all jails down.	All jails down tear now.	Jails down now all tear.
Tear jails now all down.	All now jails down tear.	Jails now tear down all.
Tear jails now down all.	All now down tear jails.	Jails now tear all down.
Tear now jails all down.	All jails now tear down.	Jails tear now down all.
Tear now down all jails.	All tear now jails down.	Jails tear now all down.
Tear all down jails now.	All jails down now tear.	Jails all tear now down.
Tear jails down all now.	All down now tear jails.	Jails tear all now down.
Tear jails all down now.	All tear down jails now.	Jails all tear down now.
Tear all jails down now.	All tear jails down now.	Jails all down tear now.
Tear jails all now down.	All now down jails tear.	Jails now down all tear.
Tear jails down now all.	All down tear now jails.	Jails tear all down now.
Tear down now all jails.	All down tear jails now.	Jails down all tear now.
Tear now all down jails.	All down now jails tear.	Jails down now tear all.
Tear down now jails all.	All down jails now tear.	Jails now all tear down.
Tear now down jails all.	All down jails tear now.	Jails down tear all now.
Tear down all jails now.	All tear jails now down.	Jails now all down tear.
Tear down jails all now.	All now tear jails down.	Jails down tear now all.
Tear all jails now down.	All tear down now jails.	Jails all now tear down.
Tear all now jails down.	all jails tear now down.	Jails down all now tear.
Tear all down now jails.	All now jails tear down.	Jails all now down tear.
Tear down jails now all.	All jails tear down now.	Jails now down tear all.
Tear down all now jails.	All tear now down jails.	Jails all down now tear.

PEOPLE: Five who speak clearly, listen closely to each other & all environing sounds, & let what they hear modify how they speak. In Way 1 they must be able to improvise together, let performance flow & their own impulses determine how they speak. Way 2 needs a precise conductor & 5 speakers who follow him accurately.
MATERIALS: 120 small cards, 5 equal squares of poster board (8 to 28 inches a side), paint/ink, pen/brush; for Way 1, 10 envelopes each large enough to hold 24 cards with room for easy removal & insertion of cards.

PREPARATION: Type permutations on cards. Experiment to find size of sign easiest to handle; size, colors, letter shapes most visible in performance situation. Make 5 square signs, each with one of the 5 words on it. For Way 1 attach 2 envelopes to each sign back & put the 24 cards whose texts begin with the sign's word in one envelope.
PERFORMANCE: Way 1: The speakers line up, holding signs parallel in the order TEAR DOWN ALL JAILS NOW. Each draws a card, listens closely to other speakers & environment until he & the situation are ready, then speaks

Down tear now jails all.
 Down now tear jails all.
 Down tear all jails now.
 Down all now tear jails.
 Down jails tear all now.
 Down jails all tear now.
 Down now all jails tear.
 Down all jails now tear.
 Down all tear now jails.
 Down jails now tear all.
 Down now jails all tear.
 Down jails now all tear.
 Down tear jails now all.
 Down tear all now jails.
 Down now jails tear all.
 Down now tear all jails.
 Down jails tear now all.
 Down all tear jails now.
 Down tear jails all now.
 Down all jails tear now.
 Down tear now all jails.
 Down all now jails tear.
 Down jails all now tear.
 Down now all tear jails.

the words as a connected sentence making good sense. Speed, loudness & voice coloration are free. He puts the card in the empty envelope & draws another, &c., until he's read each card once. It ends after last speaker finishes.
Way 2: Lined up as above, speakers face conductor, who shuffles the 120 cards & draws one, pointing in turn, in the permutation's order, to each word's bearer, who says the word, connecting it with the others so the sentence makes sense tho said by 5. Way 2 needs long intense rehearsal; ends when all 120 permutations are read.
Way 2 performed (2nd Jail Poets' Reading, Living Theatre, 9 Sept. 1963) by Judith Malina, Tom Cornell, Paul Prensny, & 2 others, conducted by JML. **Way 1** 1st performed in rain (reading against USSR jailing of writers, 30 April 1966: WIN, 11, 9: 6-7) by JML, Blackburn, Rothenberg, Antin, & the Rt. Revd. Michael F. Itkin.

Now all down tear jails,
 Now down all tear jails,
 Now tear down jails all,
 Now jails all down tear,
 Now jails all tear down,
 Now jails tear down all,
 Now down jails all tear,
 Now all tear jails down,
 Now all tear down jails,
 Now down all jails tear,
 Now jails down all tear,
 Now tear down all jails,
 Now tear all down jails,
 Now all down jails tear,
 Now tear jails down all,
 Now jails down tear all,
 Now down tear all jails,
 Now tear all jails down,
 Now all jails down tear,
 Now tear jails all down,
 Now jails tear all down,
 Now down tear jails all,
 Now down jails tear all,
 Now all jails tear down,

Figure 3.9: Jackson Mac Low's poem *JAIL BREAK* (1965) from *An Anthology of Concrete Poetry* (Williams 2013)

Realization #2: Christian Wolff's Stones	TOP => BOTTOM	
First performed 12 September 2015 (7:30 – 8:15pm)	1234	
	1243	
Take four irregularly-shaped stones	1324	
of different sizes.	1342	
Balance all four stones on top of each other	1423	
in all 24 possible orders	1432	
following the sequence on the right.	2134	
Time how long it takes to stack each permutation	2143	
and leave a silence as long as the length of the previous stacking	2314	
after each one.	2341	KEY
	2413	1 = smallest
	2431	2 = 2 nd smallest
	3124	3 = 2 nd largest
	3142	4 = largest
	3214	
	3241	
	3412	
	3421	
	4123	
	4132	
	4213	
	4231	
	4312	
	4321	

Realizations – David Pocknee (2016-11-15)

Figure 3.10: *Realization #2: Christian Wolff's "Stones"*

3.3 Combination

A prologue armed, but not in confidence
Of author's pen, or actor's voice, but suited
In like conditions as our argument

A prologue armed, but not in confidence
Of author's pen, or actor's voice, but suited

A prologue armed, but not in confidence
In like conditions as our argument

Of author's pen, or actor's voice, but suited
In like conditions as our argument

A prologue armed, but not in confidence

Of author's pen, or actor's voice, but suited

In like conditions as our argument
- Shakespeare *Troilus and Cressida*

And so you're there in that darksilence; the hush and shush of pre-sound; the way anticipation pillowsmothers the chatter of the earlybird seatstealer - centreperched - and the rest in their rings of concentric lateness. And on stage, bleached by the spotlight, a performer in knucklecracked readiness seated at the blackvoid of the piano, starting to play.

And it's the constraints that strike you, only that middle octave, the player bodylocked in place. And it's the rhythm that strikes you, regular, robotic. And it's the order that strikes you, the simple logic, unfolding between pauses:

Always begin with the lowest possible positions and move gradually up according to this rule: The lowest voice that can rise a half-tone does so and any lower voices descend to their points of departure. Each time that the top voice is going to rise a half-tone, one leaves a pause and begins a new section. (Johnson 1999, 9)

Not that you hear it that first time, in that *mezzoforte* pounding, only that gradualbuild over 70 minutes, from the anaemic emptiness of all two-note chords in that octave, through the evergoing six-note chords, through the muddy uncertainty of those 10-note chords - the changes so dense in their strangeness - to the single 13-note chord.

And it finishes, and you wait as if for the *HISCORE* screen, as if this octave has been completed. And you know that you've heard it all - all 8,178 combinations possible from that middle-C up to the C an octave above - 2- to 13- note chords all played, read out like a register. *This* is music as a branch of discrete mathematics, exhausting all possibilities, all combinations: Tom Johnson's *The Chord Catalogue* (1986).⁵

Imagine you're at that greenbaize table again, shuffled deck in hand, but now with three others cardsharks, one on each side of that cubist villagegreen. And you start dealing, sending three cards to each player. Each now has a combination of the deck. They can shuffle the cards around in their hands all they want but the order doesn't matter.

Combinations are groupings of a set. Unlike permutations, combinations deal with *unordered* sets, meaning that its ordering has no bearing on counting it as a combination or not.

⁵There are three works that are key for understanding my creative practice: Tom Johnson's *The Chord Catalogue* (Chapter 3), the second movement of Brian Ferneyhough's *Kurze Schatten II* (Chapter 1), and *Eggs* from George Brecht's *Water Yam* (Chapter 2).

Examples of combinations:

Given a set {1,2,3,4}, some possible combinations of this set are:

- (1,2,3),
- (2,3),
- (4,3),
- (3),
- (4,1,3)

Unlike permutations, a set such as (1,3,2) is considered the same as (1,2,3), as the ordering of the set has no bearing on its status as a combination, only the elements it contains.⁶

Combinations can be conceptualized as unordered subsets of a given set. The amount of possible combinations that can be made from a given set is defined by two parameters: one being the size of the set (usually notated as *n*), and one being the size of the subsets that can be made from the elements of this set (usually notated as *k*).

The amount of combinations in a set can be calculated using the binomial coefficient: "The basic combinatorial meaning of the binomial coefficient $\binom{n}{k}$ is the *number of all k-element subsets of an n-element set.*" (Matoušek & Nešetřil 1998, 56)

The binomial coefficient is defined as:

$$\binom{n}{k} = \frac{n!}{k!(n-k)!}$$

Example:

To calculate the number of possible 3-element unordered subsets (combinations) that can be made from the 5-element set (1,2,3,4,5) we can calculate:

$$\binom{5}{3} = \frac{5!}{3!(5-3)!} = \frac{120}{6 \times 2} = 10$$

This can be verified by listing all possible 3-element combinations:

- | | | |
|------------|------------|-------------|
| 1. (1,2,3) | 5. (1,3,5) | 9. (2,4,5) |
| 2. (1,2,4) | 6. (1,4,5) | 10. (3,4,5) |
| 3. (1,2,5) | 7. (2,3,4) | |
| 4. (1,3,4) | 8. (2,3,5) | |

To calculate all possible combinations of any size from 1-element up to the size of the original set (*n*-elements), the following equation can be used:

$$\sum_{k=1}^n \binom{n}{k}$$

Given the example set of (1,2,3,4,5), the number of possible combinations of subsets containing 1-5 elements, would be:

$$\sum_{k=1}^5 \binom{5}{k} = \binom{5}{1} + \binom{5}{2} + \binom{5}{3} + \binom{5}{4} + \binom{5}{5} = 5 + 10 + 10 + 5 + 1 = 31$$

And you do the math(...s) on Johnson's work, a simple doublecheck:

$$\sum_{k=2}^{13} \binom{13}{k} = 8,178$$

⁶It is conventional to designate ordered sets using curly brackets { } and unordered sets using curved brackets ().

The Chord Catalogue

(for keyboard)

TOM JOHNSON

The 78 two-note chords possible in one octave:



Figure 3.11: Extract from Tom Johnson's *The Chord Catalogue* (1986)

and wonder: on that many-teethed beast of ivory and feltpounded stretchedstrings how small the compass of Johnson's world: that single octave. and you see those great swathes of *terra incognita* that sprawl each side of it: that regular two-tone topography from basso-profundo to belltinkle; from A to shining C; those 88 keys that define this territory and their possibilities.

and you do the math(...s) and forget the practicalities: how many possible chords containing 2-88 notes are playable on the piano:

$$\sum_{k=2}^{88} \binom{88}{k} = 3.09 \times 10^{27}$$

309 septillion chords! And you know this sprawls passed the humanly possible, that most of these require more than ten fingers to play, using hands that surpass the breadth and agility of any human player, that if these were played at eight notes a second it would take 73.6×10^{18} to exhaust them, and that the age of the universe is only 13.82×10^9 years old by current estimates.

And so you write a piece, for player-piano and video, called *The Chord Catalogue (Redux)* (2015), which presents extracts from this imagined future and the mathematics behind it - a work that fast-forwards through billions of years - a taster menu for a piece of pure combinatorics unconstrained by the mundane limits of human lifespan or practicality, like a teaser trailer for a work that will never exist.

And in 1997, in the WildWesting of that earlyOnline, a work that blackmirrors back Johnson's ideas: John Simon's net-art classic *Every Icon*. It runs as a java applet in a web browser. Once the page is loaded, it starts to systematically run through all 1.8×10^{308} combinations of black and white pixels in a 32x32 grid - the size used for computer icons during this period (Mirapaul 1997).

And you imagine the speed of it running those 20 years earlier, as you see it now, hummingbird fast flickering through its options, yet still as asymptotically far from completing.

And Johnson's work, so strange in its time, now adopted by others, like Samuel Vriezen, John Lely, Michael Winter and G. Doug Barrett. Barrett's *3 Voices* (2008) consists of...

..."every possible ordering of entrances and cut-offs of sounds or actions for three performers" (Barrett 2009). From left to right, three lines, three performers, each playing a single tone, sound, or action corresponding to the 169 graphic portrayals of relative beginnings and endings, Barrett composes an exhaustive picture of a particular form of time, of time written sideways. An hour-long performance from 2008 features two violins and flute articulating the diversity of entrances and cut-offs through a series of soft iterations of the sonority: Eb4, D5, Db6.

(Priest, 2011)

And that same idea, condensed, without redundancies in Winter's *tergiversate* (2015). And also Terence Klex and his 5 hour *Some Things We Should Never Speak Of* (2015), in which every playable chord containing the notes of a C major chord are played by string quartet (Figure 3.13).

Every Icon

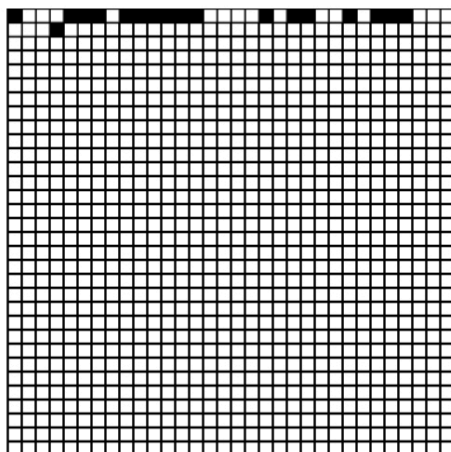

Given:
An icon described by a 32 X 32 grid.

Allowed:
Any element of the grid to be colored
black or white.

Shown:
Every icon.

Owner:
John F Simon Jr

Edition Number:
Artist's Proof

Starting Date:
January 14, 1997, 9:00:00 pm

Figure 3.12: Screenshot of John Simon's *Every Image* running as a java applet inside Firefox from <http://numeral.com/appletsoftware/eicon.html>

Some Things We Should Never Speak Of

Terence Klex

Figure 3.13: Extract from Terence Klex's *Some Things We Should Never Speak Of* (2015)

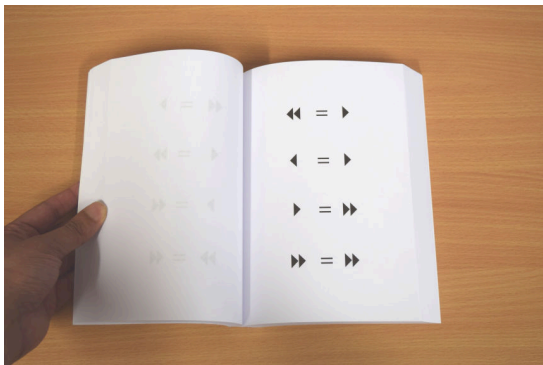

Figure 3.14: Picture of *Cipher for the Lighthouse Twins*.

And you find yourself lowceilinged onceagain in concretefloored basement and watch them facing and stageseated and bookreading ornot. Atleast holdingbooks and pageflipping but otherwatching. Two of them, informal and in comfort, as if you are now livingroomsnooping, watching their private-time - both books, lap-laid and open and identical, their titles now legcovered but, when they seated themselves, minutes earlier, with bookspines both snapshut, you saw across mottledwhitecovers the title *Cipher for the Lighthouse Twins* (2015) and watched how, in turn, they turned pages back and forward, one or two at a time.

But from your placement - shortarse you, head-forest lost - you cannot see the codes upon their pages - an occasional triangleflash - but no instruc-

tions, encrypted perhaps?

And in that aftershow-space, pre-packdown and New Schmmoozic erupting amongst the glasslink, you circle with other composervultures around the deadtreeskeletons of scorestands to pick over the carion of notation, and finally hold those bookbulks - 520 pages between paperbacks - both identical.

On each pagespread, each leftpage blank and each rightpage printed (Figure 3.14). Each rightpage shows one of all possible combinations of four symbols indicating the direction of page turning.

Each pagespread contains an ordered set of four symbols (the right-hand column in Figure 3.14). Each element in this set can be one of four different symbols.

Let these symbols be defined as a, b, c and d . In this system, the set $\{a, b, d, c\}$ can occur, but also the set $\{d, b, a, b\}$. Not all symbols need occur in each set, and symbols may occur more than once. To calculate the total of possible combinations using this system, the following equation can be used: n^r , where n is the number of elements to choose from, and r is the size of the set. In this example $n^r = 4^4 = 256$. Therefore, there are 256 printed pages in the book (excluding instructions).

3.3.1 Combination In The Visual Arts

And, like all of completism, these combinations spew outwards from a single discipline. And, in the Tate Britain, you see one of the earliest completist works in the field of the visual arts: John Hilliard's *Camera Recording its Own Condition (7 Apertures, 10 Speeds, 2 Mirrors)* (1971) (Figure 3.15):

The central image in this work, visible in varying degrees across seventy black and white photographs, arrayed in ten rows of seven across, is the artist's camera, an East German made Praktica. The camera, which is operated by Hilliard, is reflected in two mirrors, the larger of which presents a reversed image of the subject. Hilliard also holds up a smaller mirror which reflects and makes legible the camera's setting and controls. The variables governing the making of the work are indicated by the second part of its title, '7 apertures, 10 speeds, 2 mirrors' - the camera has become both the subject and object of the work, in that the seventy photographs show the images resulting from all combinations of aperture size and shutter speed in that camera. Across a diagonal axis, where the exposures are 'correct', it is possible to read the camera settings which produced each image. Where the photographs have been sequentially over or under-exposed, the next reading can usually be logically inferred.

(Tate n.d.)

The artist Sol LeWitt's output features many completist works based around combinatoric principles. In fact, of all the artists included in this survey of completist works, he is the artist whose work most frequently fits our criteria of completism, and who has more entries than any other in our list of completist works.

The ideas behind Hilliard's early serial work, produced from iterating every single combination of possibilities within a fixed system, can also be seen in LeWitt's *Incomplete Open Cubes* (1974) (Figure 3.16), which consists of:

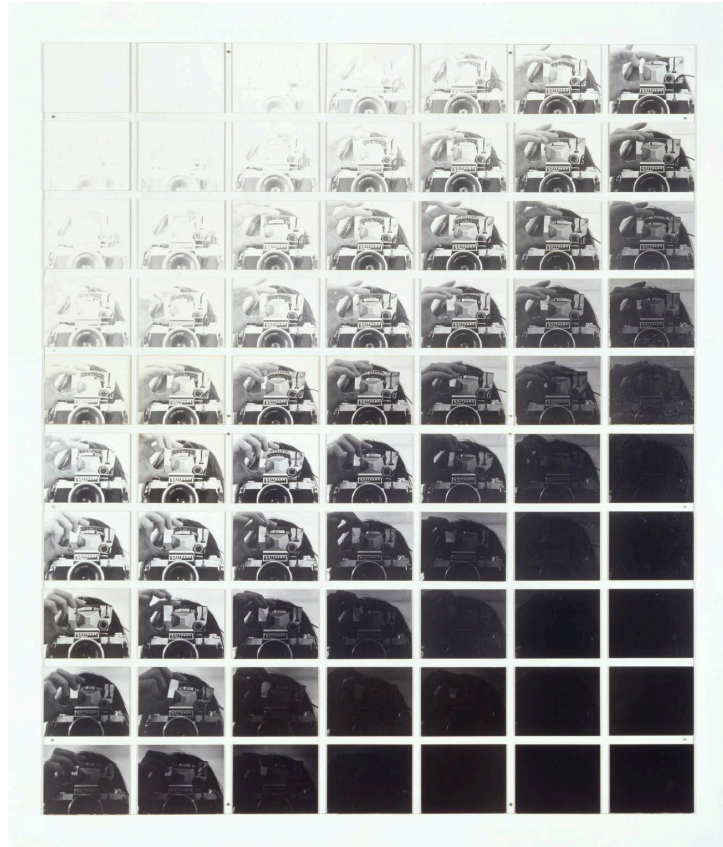

Figure 3.15: John Hilliard *Camera Recording its Own Condition (7 Apertures, 10 Speeds, 2 Mirrors)* (1971) <http://www.tate.org.uk/art/artworks/hilliard-camera-recording-its-own-condition-7-apertures-10-speeds-2-mirrors-t03116>

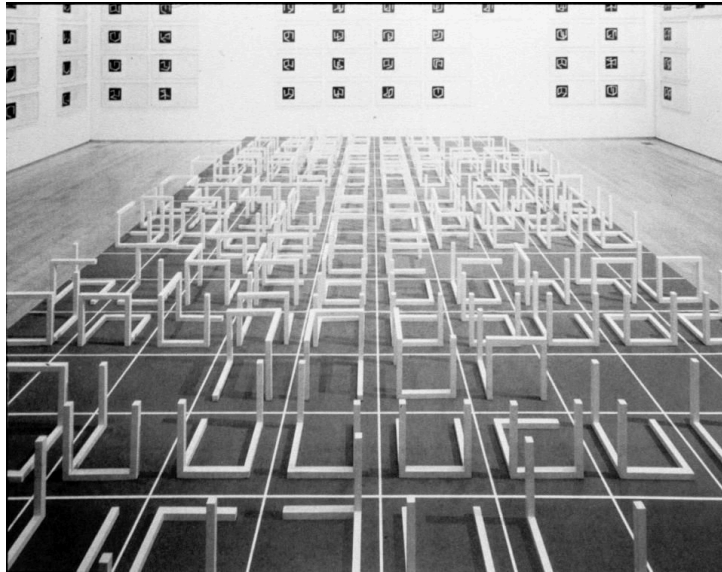

Figure 3.16: Image of Sol LeWitt's *Incomplete Open Cubes* (1974) <http://workflow.arts.ac.uk/artefact/file/download.php?file=1820206&view=177213> <http://jduggan1.workflow.arts.ac.uk/space-research>

... a collection of frame structures and a presentation of their diagrams. Each structure in the project is a cube with some edges removed so that the structure remains three-dimensional and connected.

Structures are considered to be identical if one can be transformed into another by a space rotation (but not reflection).

The list of incomplete cubes consists of 122 structures.

(Reb 2011)

This is a process mirrored in Manfred Mohr's computer-generated *Cubic Limit Series* (1972-76) (Figure 3.17), a collection of works which also uses the combinatorial possibilities of the cube as a starting point: "an alphabet of signs is created from the twelve lines of a cube. In some works, statistics and rotation are used in the algorithm to generate signs. In others, combinatorial, logical and additive operators generate the global and local structures of the images." (Mohr, n.d.)

They could feel a fast mechanical pounding shaking the metal floor of the corridor, far louder than the satellite's engines: that low hum like filtered white noise coupled with that piercing whine, just at the limit of human hearing - the reason for the deafness and insanity in the early explorers. Imagine that high-drill-whine boring into your eardrums day after day. The ship was immaculately clean and clearly had never been opened; a previous time sealed in the antiseptic air.

The door at the end of the corridor slid open automatically as they approached and suddenly the ship was filled with sound.

The room was spherical, the walls coated in wires and panels and lights. In the centre, floating in the zero-g was a grand piano playing by itself. Over its front was a mechanism rhythmically depressing the keys - some type of early solenoid technology, probably adapted for the gravityless environment (as presumably was the rest of the traditionally gravity-based piano mechanism). The instrument was tethered to the sides of the room by eight thin, transparent threads of elastic, holding it roughly in place to prevent any collisions with the sides of the room should the satellite suddenly change velocity or direction, although space-debris this far out was statistically unlikely.

It was rhythmically pulsing out eight chords every second, around a quarter of the keys being pressed down each time. The playing didn't stop for the entire time they were there.

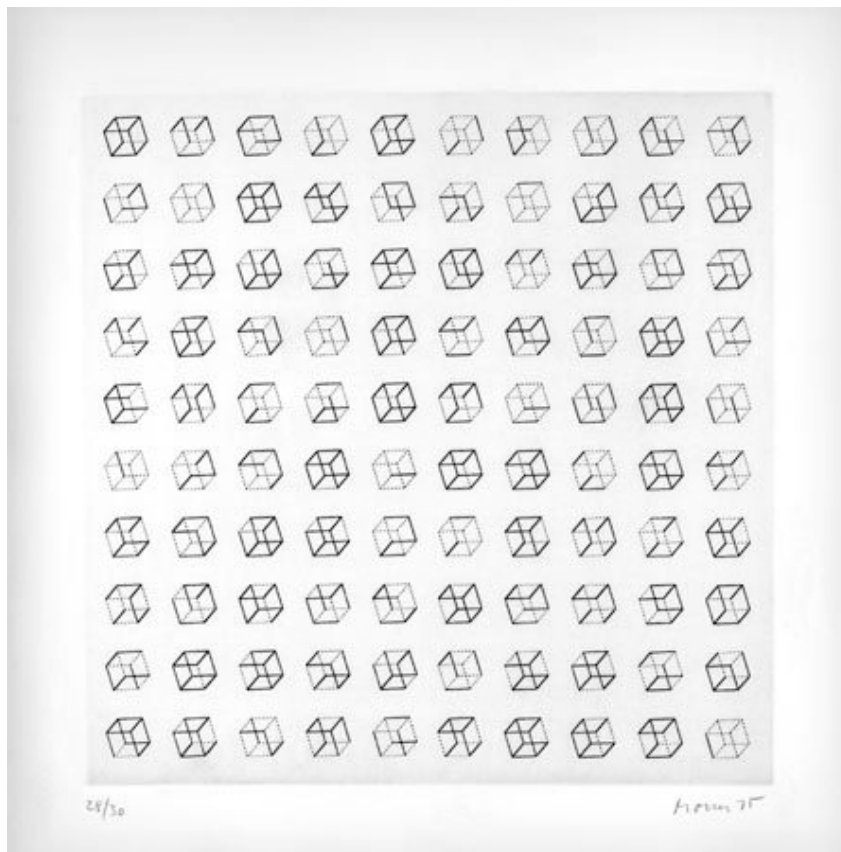

Figure 3.17: Image of etching made as part of Manfred Mohr's *Cubic Limit Series* (1974) <http://www.emohr.com/collab-exp/images/etching-2.jpg> http://www.emohr.com/ww4_out.html

It must have been playing for millenia, the hex-screen presumably keeping count had long since burnt out, and now only flickered in unintelligible bursts (counting systems had changed so drastically since this ship was built it was pretty much meaningless anyway).

It must have been orbiting the star, fuelled by solar power, just waiting to be discovered - or maybe not even that. They wouldn't know for how long until they got the archaeologists out here. The only clue to its age was the corpse slowly drifting near the peak of the room, preserved, like the rest of the ship, in a condition that was more eerie than horrifying: skin stretched taut but no decay - the janitor? the creator of this...thing? And the performance carried on without them, indifferent to their death, unfazed when its audience shrunk into passivity, continuing towards some end and an applause that would never come...

3.4 Enumeration

prologue armed, confidence
pen, voice, suited
argument
- Shakespeare *Troilus and Cressida*

You find yourself in another darksilence but now the speakers sit staged and outspill collagechunked sounds, each atomic, an ordering not audible, bits and pieces, a slower plunderphonics: the chaos of an encyclopaedia not of a corrupted hard-drive: an under-order, a structuring.

Symfonie der Duizend (1990-92) by Dutch composer Gilius van Bergeijk, translates as "Symphony of a Thousand" and is an electroacoustic piece consisting of the first note of every record in the composer's record collection played one after the other, in alphabetical order. This is then followed by the first minute of all of the recordings used, superimposed over the top of each other to create a wall of noise. van Bergeijk's work takes the fixed and finite set of the composer's record collection at a particular point in time, uses the subset of the first note of each recording and iterates each of these subsets once only, using alphabetical ordering in relation to the name of the artist responsible for the recording.

And find you alone again at that greenbaize, cards palmpiled and hardshuffled. And you sift through them, handfanned, and slowly deal to the table all of the clubs. Then, you sort that tablestack until thirteen cards are lined in order from one side of the table to the other, running from the ace of clubs on your left to the king of clubs on your right. You have enumerated the clubs.

The subcategory of completism referred to as "enumeration", encompasses works which involve the iteration once only of all subsets containing only one element which fulfil a specific criteria. In this type of work, the ordering of this enumeration is extremely important and is frequently based upon simple ascending or descending alphabetical, numerical, or chronological ordering.

At the simplest level, an example of an enumeration process could involve taking a set such as {7,3,2,4,9,1,5,6,8,10} and then applying a condition and an ordering process. For instance, if the condition is that only odd numbers will be enumerated, and the ordering will be ascending numerical order, the result would be {1,3,5,7,9}.

In enumeration artworks, the ordering of the elements is foregrounded, in contrast to combination-based works, in which this is unimportant. Enumeration artworks have an absence of combinations featuring more than one element, as opposed to the numerous-element combinations that define the combination subcategory. This subcategory also distinguishes itself from *permutation* in that only one of many possible permutations of the elements is used.

Enumeration is a technique that appears relatively late in the history of completism and is one of the few subcategories in which music appears to have taken the lead.

A later work, similar to van Bergeijk's, is Canadian composer John Abram's 68-minute composition *Vinyl Mine* (1996) which "catalogues the sound of a single pass from the play-off groove of each album comprising the (then) whole of his record collection" (Priest 2011), "at that time approximately 1100 discs, organised by category, composer/artist and date" (Abram n.d.).

These 20th Century electroacoustic approaches to musical completism were followed in the 21st Century by a slew of similar works which used completist techniques, often to highlight similarity or difference over a large set of recorded corpuses. Examples of this work are pieces such as Check TVine's *James Hetfield "Yeah!" Compilation* (2014) a catalogue of every time the singer of *Metallica* says "Yeah!" over all their albums; Paul Marshall's *How Shall We End This?* (2015), a compilation of every similar-sounding ending from the songs of the rock group *AC/DC*; and proteinjivesutra's *Beethoven's Eroica: opening chords*, a "chronological survey of the opening chords of Beethoven's Eroica Symphony" (2013).⁷

⁷It is unclear if this last work is fully completist as whether all possible recordings of Beethoven's *Eroica* are used is not stated.

The image shows a musical score extract for Figure 3.18, spanning measures 25 to 39. The score includes staves for OBOE, ENGLISH HORN, TRUMPETS in F, VIOLIN I, VIOLIN II, and VIOLAS. The OBOE part features the name 'Isolde' and dynamic markings 'f' and 'ff'. The ENGLISH HORN and TRUMPETS parts have dynamic markings 'p'. The VIOLIN I part has a 'pizz' marking. The VIOLIN II and VIOLAS parts have dynamic markings 'p'.

Figure 3.18: Extract from bar 25-39 of Act 1 Scene 1 of Eric Carlson's *At C: Every Middle C from Tristan und Isolde* (2015)

The composer, Antoine Beuger's *calme étendue (spinoza)* (1997) "consists of the successive reading of all the approximately 40,000 monosyllabic words from Spinoza's *Ethics*, painstakingly copied in their order of appearance. Each syllable is to be spoken in a very relaxed tempo (one word every eight seconds) and with a very quiet voice." (Glover & Harrison, 2013, p. 43) Similarly to van Bergeijk's work, sequential ordering is important. The ordering is applied to a subset of an existent set of material in order to bring out hidden characteristics in the original set. In both cases the "set" (van Bergeijk's record collection, Spinoza's *Ethics*) could be described as a "readymade" or "found material". Both works, although very different in their aesthetic outcomes (the overloaded chaos of van Bergeijk's work versus the quiet, spaced contemplation of Beuger's) ostensibly use an identical process for their construction: Selection of a set, selection of subsets, ordering.

Perhaps the most complex type of completist musical enumeration is seen in Scott Rickard's *Costas Golumb No. 1: The Perfect Ping* (2009), consisting of all 88 keys of the piano played only once, arranged so as to negate any intervallic doubling using a mathematical system known as a "Costas Array" and rhythmically avoiding any proportional duplication through the use of another mathematical system known as a "Golumb Ruler" (Schellinx, 2014).⁸

Probably one of the most prolific completist composers, when it comes to enumeration, is Eric Carlson. Carlson has produced several works enumerating the subsets of various historical works such as *At C: Every Middle C from Tristan und Isolde* (2015) (Figure 3.18), *The Art of the Tetrad: All Tetrads in The Art of the Fugue* (2012) and *Beethoven op. 131 mvt 1 Without Rests* (2014), all of which follow the enumeration procedure outlined in their titles to create new works from their source materials.

3.4.1 Enumeration In Literature

In literature, there are several examples of enumerative processes. Judith Goldman's poem *dicktee* (1997) is "composed of every single word in Melville's *Moby Dick* that begins with the prefix *un-*, in the exact order in which they appear" (Ngai 2000) and Christine Bergvall's aforementioned *VIA (36 Dante Translations)* (2001) collates the opening of every single English translation of Dante's *Inferno* in the British Library. Christian Bök's *Eunoia* (2001) is "a univocal lipogram, in which each chapter restricts

⁸Golumb rulers were used for building chords in my work *We Doubled Down the Base Camps*.

itself to the use of a single vowel" (Bök 2001, 103).⁹ Due to the need that these organizations of words be sense-making, the ordering of these lipograms was not algorithmically generated, and in fact took Bök seven years. His work follows other Oulipian pseudo-completist lipograms, such as Georg Perec's *La disparition* (1969) which uses no words featuring the letter E, or *Les revenentes* (1972) in which only words containing the letter E are used.¹⁰

3.4.2 Supercuts

The types of procedure outlined above have become a genre unto themselves in the discipline of net art, where the last ten years has seen rapid increase in the internet-based artform known as the *supercut*, an example of a more mainstream adoption of completist aesthetics.

A supercut is an ordered assemblage of conceptually-related fragments of movies or television series, a term apparently coined by the blogger Andy Baio in a 2008 blogpost of this type of material. However, the earliest form of this type of work seems to date back to Chuck Jones's *Buffies (first season)* (2002), which consists of "Every utterance of the word "Buffy" made during the first season of *Buffy The Vampire Slayer*" (Jones n.d.) and contemporaneous works by the artists Jennifer and Kevin McCoy *Every Anvil* (2002) and *Every Shot, Every Episode* (2001) - installations in which multiple supercuts are created from 100 *Looney Tunes* episodes and the TV show *Starsky & Hutch* (McCoy J. & McCoy K. 2012).

Supercuts are primarily a phenomena driven by the internet and video-streaming services, such as youtube.com (which launched in 2005 and resulted in a large spike in this type of work in 2006). They exist for several reasons, although, interestingly, they very rarely present themselves as art. Not every supercut is completist, as many eschew either the complete exhaustion of a finite set or do not apply ordering procedures.

⁹Along with a series of other writing restrictions "[t]he text must exhaust the lexicon for each vowel, citing at least 98% of the available repertoire (although a few words do go unused, despite efforts to include them: parallax, belvedere, gingivitis, monochord and tumulus). The text must minimise repetition of substantive vocabulary (so that, ideally, no word appears more than once)." (Bök 2001, 103)

¹⁰It is worth noting that this is the same technique used in the prologue of this section, where the only words of Shakespeare's writing that are left are those containing the letter E. One could also see a reference to Perec's work in *Almost Every*, although this was not intentional - it's more to do prevalence of this pitch class when the guitar is in standard tuning.

3.5 Re-Ordering

A actor's argument armed as author's
but but conditions confidence In in like not
Of or our pen prologue suited voice

”
- Shakespeare *Troilus and Cressida*

Once again, we find you at that greenbaize. Newdeck unwrapped and palmheld. And deal you onto that falselawn the cards in a new order: first by value, then alphabetically by suit: ace of clubs, ace of diamonds, ace of hearts, ace of spades, two of clubs, two of diamonds, two of hearts, two of spades - until the deck is completely re-ordered according to new rules.

Re-ordering has some similarities with enumeration yet, unlike enumeration, rather than involving the ordering of a subset which has been created through the application of a set of rules, re-ordering applies an ordering procedure to the entirety of the original set. Given the ordered set {7, 3, 2, 4, 9, 1, 5, 6, 8, 10}, a re-ordering might result in: {1, 2, 3, 4, 5, 6, 7, 8, 9, 10}. This could alternatively be considered as a single permutation of the given set in which the ordering is ascending and alphanumeric.

Perhaps one of the clearest examples of a completist work of re-ordering is Claude Closky's self-explanatory *The First Thousand Numbers Classified in Alphabetical Order* (1989):

Eight, eight hundred, eight hundred and eight, eight hundred and eighteen, eight hundred and eighty, eight hundred and eighty-eight, eight hundred and eighty-five, eight hundred and eighty-four, eight hundred and eighty-nine, eight hundred and eighty-one, eight hundred and eighty-seven, eight hundred and eighty-six, eight hundred and eighty-three, eight hundred and eighty-two, eight hundred and eleven, eight hundred and fifteen, eight hundred and fifty, eight hundred and fifty-eight, eight hundred and fifty-five, eight hundred and fifty-four, eight hundred and fifty-nine, eight hundred and fifty-one, eight hundred and fifty-seven, eight hundred and fifty-six, eight hundred and fifty-three, eight hundred and fifty-two . . .

Here the work subverts the conventional, numerical ordering of the set in order to impose a different alphabetical ordering. An earlier version of this technique can be found in a piece of text by Emmett Williams from 1966 called *abeeüllmmstwy* (Figure 3.19), which features a list of names of famous fictional literary characters re-ordered alphabetically in the following format: "don quixote = deinoqtux". Also of note is that the title is a re-ordered version of the author's name (Williams 2004, 30). A similar process is also at play in Gerald Ferguson's *The Standard Corpus of Present Day English Language Usage Arranged by Word Length and Alphabetized Within Word Length* (1970); Kenneth Gangemi's *Lydia* (1970) which alphabetically lists national parks; Leevi Lehto's *Päivä* (2007) which alphabetizes the Finnish News Media feed from August 20 2003; Rory Macbeth's *The Bible (alphabetized)* (2007); and Leila Brett's alphabetization of Proust's *À la recherche du temps perdu* (2004)¹¹.

Both the processes of re-ordering and enumeration have their origins in a much older, non-artistic practice: the creation of *concordances*. These were alphabetized collections of the words used in important religious or artistic works. Concordances would record each word in the text and where it was used, much like an over-detailed index, to allow easy reference. The earliest complete concordance is of the Latin Bible, compiled by the Benedictine Hugo de San Charo in the thirteenth century, reportedly with the assistance of over 500 monks (Tribble & Jones 1992, 29).

In net art, several examples of alphanumeric re-ordering are worthy of note: Firstly, Lenka Clayton's *Quaeda, Quickly, Question, Quickly, Quickly, Quiet*, which is a video alphabetization of George W. Bush's "Axis of Evil" speech (Clayton 2010, 40). Secondly, Tom 7's *ARST ARSW* (2014), a video alphabetization of dialogue from the film *Star Wars*, and the related *AARRSSTW - WTSSRRRAA* (2013) by %20, in which the 1997 *Star Wars* Special Edition movie is resorted by shot length (ascending and

¹¹Some of these can be seen in Dworkin and Goldsmith's *Against Expression* collection (Dworkin 2011)

Alphabetized Winterreise

Franz Schubert / Erik Carlson

(suggestion for performance:
two singers alternate measures)

Figure 3.20: Extract of Eric Carlson’s *Alphabetized Winterreise* (2013) <http://midnightsledding.com/carlson/AlphabetWinter.pdf>

descending). Thirdly, the recent *Of Oz the Wizard* (2015) by Matt Bucy, which involves the alphabetical re-ordering of the the film *The Wizard Of Oz*.

These works have a lineage back to Anne McGuire’s *Strain Andromeda, The* (1992), which is a re-edited version of Robert Wise’s 1971 science fiction film *The Andromeda Strain* in which the order of shots is reversed, so that the last shot appears first and the first last (vdb n.d.).

In music, examples of completist works of re-ordering include Jasna Veličković’s *Good Bach* (2001/4) and Eric Carlson’s *Aaccino* (2013), both of which take works by Bach and re-order the pitches within them in ascending order. Similar is Carlson’s *Alphabetized Winterreise* (2013) (Figure 3.20), which uses the text of Schubert’s song cycle as the basis for the re-ordering. Also worthy of note is Luke Nickel’s *Reorganization* series (2012) which provides a list of instructions for the re-arrangement of an existing musical work in a way which will frequently produce completist works. One existing realization involves the re-ordering of the vocal line of Bikini Kill’s *Alien She*. All of these works clearly have strong connections to earlier, literary works, such as the Claude Closky piece discussed earlier.

abeeillmmstwy

don quixote	=	deinooqtux
tom jones	=	ejmnoost
david copperfield	=	acddeefilopprv
captain ahab	=	aaaabchinpt
emma bovary	=	aabemmorvy
pierre bezuhov	=	beehioppruz
raskolnikov	=	aiklnoorsv
huckleberry finn	=	bceefhiknrruy
lord jim	=	dijlmor
leopold bloom	=	bdellmoooop
hans castorp	=	aachnoprst
joseph k.	=	ehjkops
frederick henry	=	cdeefhiknrry
thomas sutpen	=	aehmnpsttu
tom joad	=	adjoomt
		adn
		elst
		aekt
		ffo
		fomr
		eehr!
		eknorwy
		ailpr 1669

Figure 3.19: Emmett Williams’ *abeeillmmstwy* (1966) from *Manifestos* (2004, p. 30)

3.6 Mapping

1 8 6, 3 3 2 10
 2 7 3, 2 7 5, 3 6
 2 4 10 2 3 8

- Shakespeare *Troilus and Cressida*

And under the dulllight and the greenbaize, you would practice your memory. You could memorize an entire pack of cards. A mnemonic device, the "peg system" (Brown 2006, 69-114) - each card-number translated into an image, used for recalling the deck's order. You hold a shuffled deck and turn over the top card: the 7 of clubs - reverse it - clubs seven - clubs becomes "C", seven becomes "T" - fill in a vowel - "a" - and seven of clubs becomes the mental image of a "CaT". A mapping.

This sub-category involves the mapping of the entirety of one set onto another. This mapping, in mathematical terms, must be "bijective", in other words, each element in one set can only map onto one and only one element of the other set. A bijective mapping of the ordered set {A,B,C,D,E,F,G,H,I,J} onto the ordered set {1,2,3,4,5,6,7,8,9,10} could then be used to translate between the two types of material contained in each set, such that an ordered subset of the first {D,I,C,E} could then be used to create a corresponding ordered subset of the second {4,9,3,5}.

In a completist mapping, this relation is frequently used to exhaust a particular permutational set of possibilities offered by the first set. For example, listed below are all possible 5-letter words made from the set {A,B,C,D,E,F,G,H,I,J} and occurring in the *Scrabble Dictionary* mapped to their counterparts in the ordered set {1,2,3,4,5,6,7,8,9,10} :

{a,b,i,d,e} = {1,2,9,4,5}	{c,a,d,i,e} = {3,1,4,9,5}	{f,a,d,g,e} = {6,1,4,7,5}
{a,c,h,e,d} = {1,3,8,5,4}	{c,a,g,e,d} = {3,1,7,5,4}	{f,i,c,h,e} = {6,9,3,8,5}
{b,a,d,g,e} = {2,1,4,7,5}	{c,e,b,i,d} = {3,5,2,9,4}	{f,i,d,g,e} = {6,9,4,7,5}
{b,a,g,i,e} = {2,1,7,9,5}	{c,e,i,b,a} = {3,5,9,2,1}	{g,a,d,j,e} = {7,1,4,10,5}
{b,e,a,c,h} = {2,5,1,3,8}	{c,h,a,f,e} = {3,8,1,6,5}	{g,i,b,e,d} = {7,9,2,5,4}
{b,e,g,a,d} = {2,5,7,1,4}	{c,h,i,d,e} = {3,8,9,4,5}	{h,a,d,j,i} = {8,1,4,10,9}
{b,h,a,j,i} = {2,8,1,10,9}	{c,h,i,e,f} = {3,8,9,5,6}	{h,e,j,a,b} = {8,5,10,1,2}
{b,i,g,a,e} = {2,9,7,1,5}	{d,e,b,a,g} = {4,5,2,1,7}	{h,i,j,a,b} = {8,9,10,1,2}
{b,i,g,h,a} = {2,9,7,8,1}	{d,e,c,a,f} = {4,5,3,1,6}	{i,c,h,e,d} = {9,3,8,5,4}
{c,a,d,g,e} = {3,1,4,7,5}	{f,a,c,e,d} = {6,1,3,5,4}	{j,e,h,a,d} = {10,5,8,1,4}
		{j,i,b,e,d} = {10,9,2,5,4}
		{j,i,h,a,d} = {10,9,8,1,4}

In contrast to other types of completism, in which the set undergoing the permutation, combination or enumeration procedure is presented as the final product, mapping instead presents a secondary set as the output. In the example above "abide" is not the first of our results, "1 2 9 4 5" is. Although the process of mapping has a long history in cryptography, it is only in the twenty-first century that this type of completism has frequently occurred in artworks.

Poem (2017-02-15)

20 18 1 14 19 12 1 20 9 15 14

Figure 3.21: Poem



Figure 3.22: Extract from Luiz Henrique Yudo's *On Words: J*, arranged by Sergei Zagny (2012)

his net-art works *Drei Klavierstücke op. 11* (2009), which is "a recreation of Arnold Schoenberg's 1909 op. 11 *Drei Klavierstücke* (aka *Three Piano Pieces*) made by editing together videos of cats playing pianos downloaded from Youtube" (Arcangel 2009) or *Paganini Caprice No. 5* (2011) in which videos of amateur guitar players from youtube are used to reconstruct the work of the title (Arcangel 2011). An early example of this type of work is *A Wild Hare* by the rock band Spastic Ink (1997) in which every word from the character Thumper in the film *Bambi* is transformed into a guitar melody with accompaniment.

Examples of works using mapping include Luiz Henrique Yudo's *On Words* (2000-1) (Figure 3.22) in which all the words starting with a particular letter in the dictionary are transformed into music using a systemized set of rules based on braille. A similar type of process is found in Rama Gottfried's *Langenscheidt Euro-Edition Teil A* (2009) (Figure 3.24) for violinist and performer, this time using words beginning with A from a German dictionary. Michael Oesterle's *All Words* (2014) for choir "sets, in alphabetical sequence, all 1,015 three-letter words from the *Official Scrabble Players Dictionary*" (Rutherford-Johnson 2015), although here the application is much less systematised.

Other examples include Anton Wasiljew's *Das Kapital Study* (2013) which uses the text of Karl Marx's *Das Kapital* as an ordered set in which each word is turned into a sound, with only the words "labour" and "money" getting sonic signifiers. Cory Arcangel uses a mapping procedure in

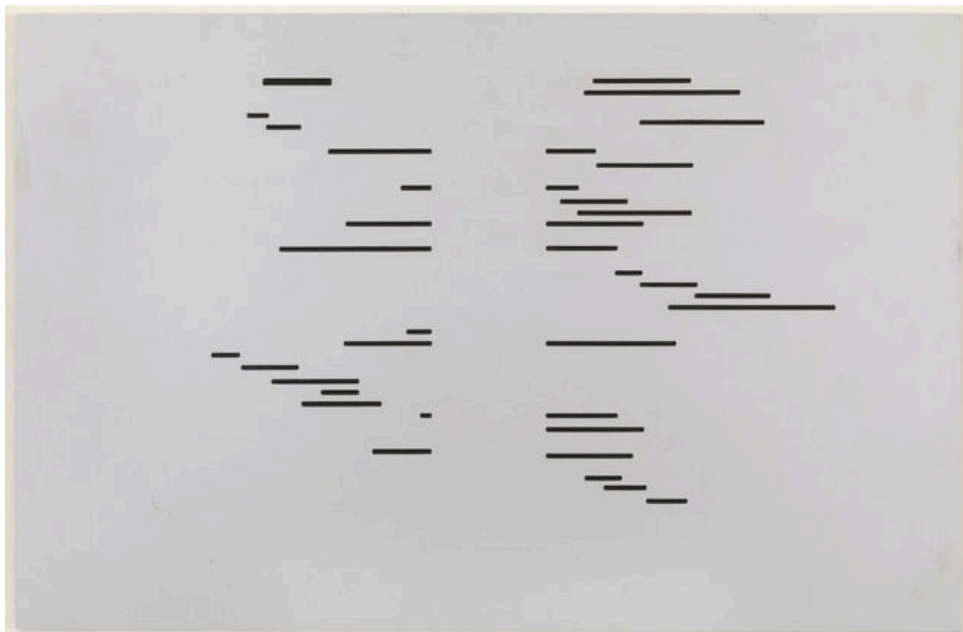

Figure 3.23: Extract from Marcel Broodthaers's *Un Coup de dés jamais n'abilora le hasard* <http://www.moma.org/collection/works/146983>

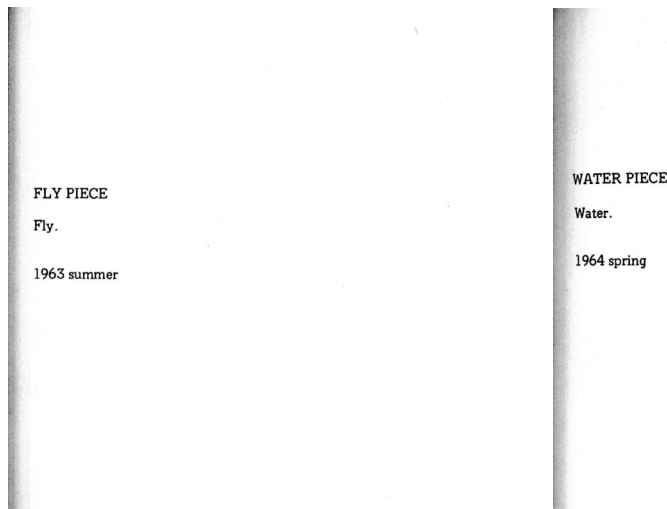

Figure 3.25: Two scores from Yoko Ono's *Grapefruit* (1964).

Marcel Broodthaers's *Un Coup de dés jamais n'abilora le hasard* (Figure 3.23), utilises the typographical arrangement of Mallarmé's poem of the same name by replacing the text with black rectangles, leaving only the layout of the writing, divorced from the words themselves. This mapping procedure was taken even further in the identically titled 2009 work by Michalis Pichler in which these arrangements of black rectangles are punched into a player piano roll and transformed into music.

This process is similar to that applied in my *Augenmusik 1b-e*, in which the ejaculate-covered sheets of paper used in *Augenmusik I: The Grid Is A Terrible Moment For Sensitivity And Substance (after John Cage and Jordan Mackenzie)*, described in Chapter 1, are translated into sound via the imposition of different sizes of rhythmic and pitch grids, using a computer algorithm.

My work *MG3250 Performs Cornelius Cardew's "Treatise"* (2015) consists of a recording of an inkjet printer printing the score of Cardew's graphic work, proposing that this may be a valid interpretation of the score, as every graphic element of the score is mapped into sound.

NFO: Book Of Fluxus-Style One-Word Verb Pieces (Figure 3.26) is a work I made in 2013 which uses a corpus of verbs from an online English-language word-list to create 13,718 one-word text scores in the style of those found in Yoko Ono's *Grapefruit* (see Figure 3.25). This is a net art work which only exists as an online webpage and randomly re-orders the scores on the page each time it is loaded. In some ways this is similar to the *sortes* divination procedure discussed in the last chapter. This work was part of an ongoing project called the *New Fordist Organization* which uses techniques pioneered by Henry Ford to mass-produce artworks.



Figure 3.24: Extract from Rama Gottfried's *Langenscheidt Euro-Edition Teil A* (2009)

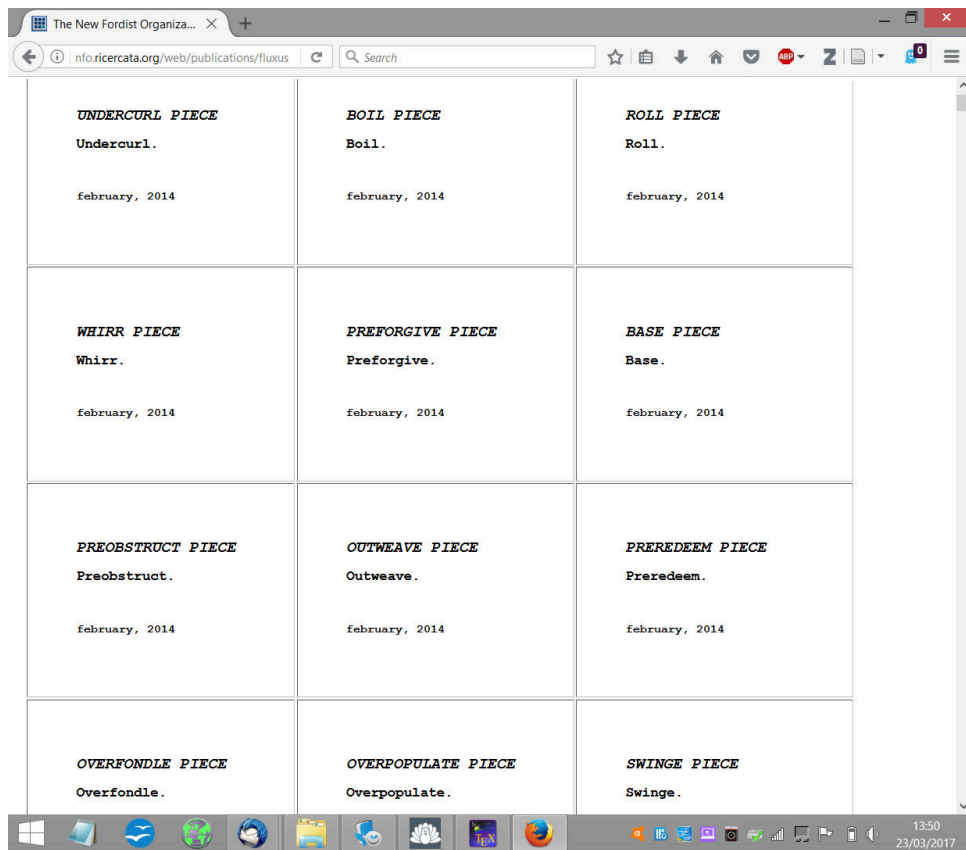

Figure 3.26: Extract from *NFO: One-Word Fluxus Text Scores* running in *Firefox*.

3.7 Direct Transcription

*A prologue armed, but not in confidence
Of author's pen, or actor's voice, but suited
In like conditions as our argument
- Shakespeare Troilus and Cressida*

We step and do not step into the same rivers; we are and are not.
- Heraclitus (Curry 2010)

The game had finished, the chairs now vacant around that dull-lit lawn of greenbaize and centre-stacked cards of that last game still ... but now quickly forgotten. You didn't deal the last round, it was he to your left, now emptychaired and ghosted. And so you fan them face-up - the derangements of another's randomhands now outsmeared.

You take a new pack, pocket-stashed and still cocooned, and unravel its transparent skin. You lidpick, boxshake and palmcatch, the contents now handsat. And you begin to place the cards from your hand onto the greenbaize below that of that fan of othershuffles, so that each newdeck card sits below its aged twin, until two identically ordered decks sit fanned on the table: a deck of someone else's shuffle, and your exact copy.

Direct transcription is a type of completism which involves the copying of an existing artwork, with the intent that this replication is as close to the original as possible. Sometimes this is done through a process of human transcription, other times it involves computerised duplication of the work.

Mathematically, direct transcription could be seen as a bijective mapping of an ordered set such that $x_n = y_n$. For instance, the mapping of the ordered set $\{1,2,3,4,5,6,7,8,9,10\}$ onto the set $\{1,2,3,4,5,6,7,8,9,10\}$.

Direct transcription is a way of working which has gained popularity in the literary field largely due to the conceptual writing movement. The poet Kenneth Goldsmith's *Day (The Figures)* (2003) is a re-typed copy of all of the text of the 1 September 2000 edition of the *New York Times*, published as a book. Simon Morris's *Getting Inside of Jack Kerouac's Head* (2008) is a re-typing of the entirety of Kerouac's *On The Road*; Robert Fitterman's *Directory* (2009), which consists of the directory of an unnamed mall (Goldsmith, p. 97); and Vanessa Place re-purposes legal documents in *Statement of Facts* (2008), *Statement Of The Case* (2011) and *Argument* (2011) (Goldsmith, 2011, p.101).

Although there are not many musical examples of this type of completism, notable are the recordings released by Zenph Studios, in which famous recordings of solo piano music are subjected to computer analysis and then re-performed by an extremely accurate player-piano system. Zenph Studios have released four albums utilising this technology on performances by Rachmaninoff, Art Tatum, Oscar Peterson and a re-creation of Glenn Gould's 1955 recording of Bach's *Goldberg Variations*.

Whilst Zenph Studios have attempted direct transcription through technological means, in 2014 the jazz group *Mostly Other People Do The Killing* released an album entitled *Blue* (2014) in which the group attempts to recreate note-for-note the entirety of Miles Davis's *Kind Of Blue* album.

3.8 Defining Completism

In the previous sections of this chapter, six main categories of completist works were given (permutation, combination, enumeration, re-ordering, mapping and direct transcription) along with the beginnings of an outline of a completist canon.

Again, completism can be defined as follows:

A completist work consists,
almost solely,
of the systematic exhaustion
of specific combinatorial possibilities,
iterated once only,
of the subsets (and/or their relations)
of a fixed and finite set of discrete elements.

To simplify, there are three elements which allow the construction of a completist work:

1. The Set
2. The Subsets and/or their relations
3. The Ordering

3.8.1 The Set

All completist works are based around a set of material, whether it be the 13 notes in an octave in Tom Johnson's *The Chord Catalogue*, the film *The Andromeda Strain* in Anne Mcguire's *Strain Andromeda The*, or all possible camera settings in John Hilliard's *Camera Recording its Own Condition*. One of the key elements about all of the sets mentioned above is that they have several characteristics:

The Set Is Fixed

The sets in completist works are fixed, meaning that the set does not change during the course of the artwork. The set is the same at the beginning of the work as at the end, a fact that allows the full exhaustion of its combinatoric possibilities.

The Set Is Finite

The sets used in a completist work must be finite. This excludes works made using infinite or transfinite sets. This means that, while it may be tempting to label the artist Roman Opalka's $1 - \infty$ series of canvasses, which are filled with tiny, painted, incrementally-increasing lists of natural numbers, as completist, they are not. The set of natural numbers is infinite, and Opalka's series was only terminated by his death in 2011. The infinite nature of the set prevents its exhaustion - a necessity for a work to be completist.

The Set Is Discrete

The use of discrete sets is an important element of the completist approach, as the use of discrete elements defines the type of mathematics that can be used. Combination, permutation, enumeration, mapping and re-ordering are techniques from discrete mathematics, of which completism can be considered an aesthetic offshoot.

The focus upon discrete elements means that many works which might, on the surface, appear to be completist, are in fact, only pseudo-completist due to their use of continua. Works such as James Tenney's *Postcard Piece No. 4: Koan* (1971) for solo violin, Michael Snow's video work *Wavelength* (1967), or John Lely's *The Harmonics of Real String* (2006/13), all involve continuous movement (the slow glissando over the entirety of a string instrument in Tenney and Lely, and a slow zoom in the Snow) that, cover all intervals between one point and another, but do so in a way that does not feature the discreteness necessary for completist works. Andy Warhol's *Empire* (1964) and *Sleep* (1963), both featuring long, static shots, also fail to meet the discreteness criteria, as does Douglas Gordon's *24 Hour Psycho* (1993).

3.8.2 The Subsets and/or Their Relations

The size and type of subsets used will partly define the types of completist procedures that can be performed. One choice is whether the subsets themselves, or the relations between the subsets will be the focus of the completist operations. In van Bergeijk's work, the subset of all first notes of recordings in his record collection is used, whereas in Scott Rickard's work, the relations *between* the elements (i.e. the musical intervals) are the elements being exhausted.

Completist works tend to consist of subsets or sets which coincide with the entirety of a typological classification which is identifiable outside of itself. e.g. rather than "13 chords chosen by the composer from some Bing Crosby songs", it would be "all chords from every Bing Crosby song". Here the typology delineating both chords and the number of Bing Crosby songs is established and defined externally to the completist work, which involves the exhaustion of that typology.

3.8.3 The Ordering

The System

There is often a systematic or algorithmic approach to the ordering of elements in a completist work. Often this is extremely simple, as with alphanumeric or chronological ordering, in order to foreground the systematized nature of the material.

Iterated Once Only/Exhaustion

Key to the completist aesthetic is an idea best summed up in this quotation from Webern, talking about his *Bagatelles* (1911) (Op. 9) (Webern, 1963):

... about 1911 I wrote the *Bagatelles for String Quartet* (Op. 9), all very short pieces, lasting a couple of minutes perhaps the shortest music so far. Here I had the feeling, "When all twelve notes have gone by, the piece is over."
(Webern, 1963, p.51)

Webern's actual compositions, however, are not completist, due to the subclause in the definition of completism which states that combinatorial possibilities be "iterated only once" (Figure 3.27).

However, this specification cuts both ways. Whilst a completist work must enumerate its specific set of combinatorial possibilities not more than once, they must also not be enumerated less than once, a stipulation which excludes several works which set out a network of all possibilities, yet fail to enumerate all of them.

An early example of this tendency of partial enumeration in pseudo-completist works can be seen in the popular musical dice games of the 18th century (Hedges, 1978). These dice games introduced chance procedures to musical composition by using dice rolls to determine the orderings of pre-composed musical segments but only ever enumerate one possibility at a time.

Similarly, Raymond Queneau's *100,000,000,000,000 Poems* (1961) provides the possibility of generating a vast amount of sonnets by allowing for 10 sonnets of 14 lines each to be recombined in as many ways as possible: 10^{14} different combinations or 100 billion possible sonnets (Matthews & Brotchie 2005). The need for all combinations to be iterated for a work to be truly completist means that Queneau's poem is not truly completist, neither is Daniel James Wolf's musical version of Queneau's work, *100,000,000,000,000 PIECES FOR CLARINET* (2011-12), although a work which presented all possible sonnets simultaneously would be considered completist.

This is why Thomas Pynchon's multiple grammatical permutations of the words "you" "never" "did" "the" "Kenosha" "kid" in Thomas Pynchon's *Gravity's Rainbow* (Pynchon 1995, 60-61) is not completist, but Darius Kazemi twitter feed (<https://twitter.com/YouNeverDidTh>) which enumerates all of them is.¹²

¹²(3) Minor employee: Well, he has been avoiding me, and I thought it might be because of the Slothrop affair. If he somehow held me responsible -

Superior (haughtily): You! never did the Kenosha Kid think for one instant that *you* ... ?

(3.1) Superior (incredulously): You? Never! Did the Kenosha Kid think for one instant that *you* ... ?"
(Pynchon 1995, 60-61)

Correction #2

David Pocknee
2017-3-27

Sechs Bagatellen für Streichquartett 3

Alle Rechte vorbehalten
All rights reserved

I
Anton Webern, Op. 9

Mäßig (♩. ca 60)

I. Geige 1 mit Dämpfer 2

II. Geige mit Dämpfer

Bratsche am Steg - mit Dämpfer am Steg

Violoncell mit Dämpfer

rit. tempo accel. heftig rit.

wieder mäßig (♩. ca 60)

Copyright 1924 by Universal Edition A. G., Wien
Revised Copyright 1932 by ...

C# D# E# F# G# A# B#

What happened? I can only relate something from my own experience; about 1911 I wrote the "Bagatelles for String Quartet" (Op. 9), all very short pieces, lasting a couple of minutes—perhaps the shortest music so far. Here I had the feeling, "When all twelve notes have gone by, the piece is over." Much later I discovered that all this was a part of the necessary development. In my sketch-book I wrote out the chromatic scale and crossed off the individual notes. Why? Because I had convinced myself, "This note has been there already." It sounds grotesque, incomprehensible, and it was incredibly difficult. The inner ear decided quite rightly that the man who wrote out the chromatic scale and crossed off individual notes was *no fool*. (Josef Matthias Hauer, too, went through and discovered all this in his own way). In short, a rule of law emerged, until all twelve notes have occurred, none of them may occur again. The most important thing is that each "run" of twelve notes marked a division within the piece, idea or theme.

My Goethe song, "Gleich und Gleich" (Four Songs Op. 12, No. 4, com- sharp -A-D then a ch-

Figure 3.27: The score of *Correction #2*.

A completist work iterates *all* of its total possibilities once and once only.

3.8.4 The Aesthetic: Almost Solely

Fundamental to the aesthetics of completism, is the intention for these works to be viewed as art. This distinguishes completism from the use of combinatorics as an educational tool or mathematical exercise.

The idea of a completist work consisting "almost solely" of the iteration of a completist process is probably the criteria most open to subjectivity in the definition we have put forward. It is key that a completist work foregrounds its completist nature. This foregrounding often takes shape in the ordering of the material according to a simple system, easily understood by a potential audience, or by holding many of the other parameters in the piece static, whilst the parameter being permuted, re-ordered, enumerated etc. changes.

This means that many works, although built upon completist principles, do not count as completist unless this systematized process is the main focus of the work. This discounts works such as the third movement of Brian Ferneyhough's solo guitar piece *Kurze Schatten II* (1983-89) which is based on "a large table of all possible guitar finger positions – from 1st to 18th position, if I recall correctly – and all possible combinations of four fingers over any combination of the six strings" (Ferneyhough, 1993, pp. 146-147), or Andrew Greenwald's string quartet *A Thing Is A Hole In A Thing It Is Not* (2012), which uses the 15 possible instrumental combinations available within the string quartets instrumentation as a formal construct (Greenwald, 2012). Both of these works contain a high degree of change in other compositional parameters which obscure these basic completist procedures.

3.8.5 The Elements of Completism

Completism can thus be broken down into these four elements:

1. The Set
 - Fixed
 - Finite
 - Discrete Elements
2. The Subsets and/or their relations
 - How are the subsets defined?
 - What are their combinatorial possibilities?
 - Combination
 - Permutation
 - Enumeration
 - Mapping
 - Re-ordering
 - Direct Transcription
3. The Ordering
 - Chronological/alphabetical/numerical/algorithmic
 - Once and once only
4. The Aesthetic
 - Almost Solely

3.9 List Of Completist Works

Built with Beavan Flanagan.

AUTHOR	WORK	DATE	MEDIUM
Christoph Graupner	Canon with 5626 Inversion	1730-35	music
Various	Change Ringing	1700s	music
Joseph Cornell	Rose Hobart	net art	video art
Brion Gysin	I AM THAT I AM	1959	poetry
Brion Gysin	Pistol Poem	1960	poetry
Brion Gysin	Junk Is No Good Baby	1960	poetry
Brion Gysin	Kick That Habit Man	1960	poetry
Brion Gysin	No Poets Dont Own Words	1960	poetry
Brion Gysin	I Dont Work You Dig	1960	poetry
Brion Gysin	This Is Sam Francis	1960	poetry
Brion Gysin	Pistol Poem	1960	sound-art
Emmett Williams	Cellar Song for Five Voices	1960	music
Marc Adrian	Text I	1963	video art
Dan Flavin	the nominal three (to William of Ockham)	1963	visual art
Alison Knowles	Performance Piece #8 (Summer, 1965)	1965	music
Alison Knowles	Word Power	1966	literature
Jackson Mac Low	Jail Break	1966	poetry
On Kawara	I Read	1966	visual art
Sol LeWitt	Serial Project #1 (ABCD)	1966	visual art
Ed Ruscha	Every Building On The Sunset Strip	1966	photography
Emmett Williams	abeeillmmstwy	1966	poetry
Sol LeWitt	Three-Part Variations on Three Different Kinds of Cubes	1967	visual art
Tomás Marco	Das Augenblicht (homage to anton webern)	1967	performance art
Robert Morris	Permutation	1967	sculpture
Robert Morris	Untitled (Drawing for 380 Possible Fibreglass, Steel, Aluminium Pieces)	1967	Drawing
Emmett Williams	Sweethearts	1967	poetry
Bruce Nauman	Study for First Poem Piece	1968	visual art
George Perec	The Machine	1968	theatre
Marcel Broodthaers	Un Coup de dés jamais n'abilora le hasard	1969	visual art
Deborah Hay	20 Permutations of 2 Sets of 3 Equal Parts in a Linear Pattern	1969	choreography
On Kawara	One Million Years-Past	1969	visual art
Gerald Ferguson	The Standard Corpus of Present Day English Language Usage Arranged by Word Length and Alphabetized Within Word Length	1970	literature
Kenneth Gangemi	Lydia	1970	literature
Sol LeWitt	One-, Two-, Three- and Four-Part Combinations	1970	visual art
Mel Bochner	Axiom of Exhaustion	1971	visual art
John Hilliard	Camera recording its own condition	1971	photography
Sol LeWitt	49 Three-Part Variations on Three Different Kinds of Cubes	1971	visual art
Alighiero e Boetti	Untitled (Victoria Boogie Woogie)	1972	visual art
Manfred Mohr	Cubic Limit series	1972	visual art
Sol LeWitt	All Combinations of Arcs from Corners and Sides	1973	visual art

Sol LeWitt	Incomplete Open Cubes	1974	Installation
Sol LeWitt	Five Cubes on Twenty-Five Squares (sides touching/corners touching)	1977	visual art
George Perec	Life: A User's Manual	1978	literature
Philippe Bootz	Combinatory Poems on Minicomputer	1979	poetry
On Kawara	I Went	1968-79	visual art
On Kawara	I Met	1968-79	visual art
On Kawara	I Got Up At	1968-79	visual art
On Kawara	One Million Years-Future	1980	visual art
Samuel Beckett	Quad	1981	theatre
Tom Johnson	Tango	1984	music
Tom Johnson	Chord Catalogue	1986	music
Tom Johnson	Music and Questions	1988	music
Claude Closky	The First Thousand Numbers Classified in Alphabetical Order	1989	literature
Janet Zweig	The 336 Lines Currently Expunged from Shakespeare's Romeo and Juliet in Ninth-Grade Textbooks	1989	literature
Sol LeWitt	Figures and Their Combinations	1991	visual art
Anne McGuire	Strain Andromeda, The	1992	video art
Gilius van Bergijk	Symphony of 1000 [Symfonie der Duizend]	1992	music
Sol LeWitt	One-, Two-, Three-, and Four-Part Combinations of Vertical, Horizontal and Diagonal Left and Right Bands of Color	1994	visual art
Tracey Emin	Everyone I Have Ever Slept With (1963-1995)	1995	visual art
John Abram	Vinyl Mine	1996	music
Antoine Beuger	calme étendue (spinoza)	1997	music
Judith Goldman	dictee	1997	poetry
Spastic Ink	A Wild Hare	1997	music
John Simon	Every Icon	1997	net art
Chuck Jones	NPR Inhale	1998	sound art
Lisa Jevbratt	1:1	1999	net art
Brian Kim Stefan	The Dreamlife of Letters	1999	net art
Christine Bergvall	VIA (36 Dante Translations)	2001	literature
Christian Bök	Eunoia	2001	literature
José Luis Castillejo	TLALAATALA	2001	literature
Kenneth Goldsmith	Soliloquy	2001	literature
Jennifer & Kevin McCoy	Every Shot, Every Episode	2001	visual art
Luiz Henrique Yudo	On Words	2001	music
Jasna Veličković	Good Bach	2001	music
Chuck Jones	Buffies (first season)	2002	supercut
Chuck Jones	Loveline Questions	2002	sound art
Chuck Jones	Five More Isolation Studies	2002	sound art
Jennifer & Kevin McCoy	Every Anvil	2002	visual art
Chedomir Barone	Piano Installation with Derangements	2003	music
Kenneth Goldsmith	Day (The Figures)	2003	literature
Tom Johnson	Combinations for String Quartet	2003	music
Leila Brett	À la recherche du temps perdu	2004	literature
Brendan Dawes	Cinema Redux	2004	visual art
Kenneth Goldsmith	The Weather	2005	literature
Unknown	Scarface F Word	2006	supercut
Samuel Vriezen	Within Fourths / Within Fifths	2006	music

Stormy Lang	Casino The Fucking Short Version	2006	supercut
Stormy Lang	The Big Lebowski - The Fucking Short Version *featured*	2006	supercut
yukole1	Fargo Yeah	2006	supercut
Cory Arcangel	Every Other C.S.N.Y.	2007	visual art
Elizabeth S. Clark	Between Words	2007	literature
Martin Creed	Piano accompaniment (No. 736)	2007	installation
Craig Dworkin	Parse	2008	literature
Kenneth Goldsmith	Traffic	2007	literature
Leevi Lehto	Päivä	2007	literature
Rory Macbeth	The Bible (alphabetized)	2007	literature
Adam Parrish	@everyword	2007	net art
skywalkerpotter21	Shia LaBeouf in "No No No NOo" video	2007	supercut
zebonka	Star Trek I - X Montage	2007	supercut
Zenph Studios	Zenph Re-Performance: Bach: Goldberg Variations 1955 / Gould	2007	music
G. Douglas Barrett	Three Voices	2008	music
Kenneth Goldsmith	Sports	2008	literature
Simon Morris	Getting Inside of Jack Kerouac's head	2008	literature
Vanessa Place	Statement of Facts	2008	poetry
Zenph Studios	Zenph Re-Performance: Piano Starts Here - Art Tatum: Live At The Shrine	2008	music
Cory Arcangel	Drei Klavierstücke op. 11	2009	net art
Robert Fitterman	Directory	2009	poetry
Robert Fitterman	The Sun Also Rises	2009	literature
Rama Gottfried	Langenscheidt Euro (Edition Teil A)	2009	music
Michalis Pichler	Un Coup de dés jamais n'abilora le hasard	2009	music
Scott Rickard	Costas Golumb No. 1: The Perfect Ping	2009	music
taylorcreviston	Kramer's Entrance Supercut	2009	supercut
Zenph Studios	Zenph Re-Performance: Rachmaninoff Plays Rachmaninoff	2009	music
Philipp Adrian	An Index	2010	literature
Lenka Clayton	Qaeda, Quality, Question, Quickly, Quickly, Quiet	2010	net art
Johannes Kreidler	Vier Konzeptuelle Stucke	2010	net art
Bruce Nauman	For Beginners (all the combinations of the thumb and fingers)	2010	video
Cory Arcangel	Paganini Caprice No. 5	2011	net art
Tauba Auerbach	RGB Colorspace Atlas	2011	visual art
Christopher Delaurenti	Of Silences Intemporally Sung: Luigi Nono's Fragmente-Stille, an Diotima	2011	sound art
Maura Hazeldon	Pride & Prejudice, Movement: Past, Possible, Present	2011	literature
Jörg Piringer	Unicode	2011	video art
Vanessa Place	Statement Of The Case	2011	literature
Vanessa Place	Argument	2011	literature
Zenph Studios	Zenph Re-Performance: Oscar Peterson: Unmistakable	2011	music
Philipp Adrian	#oneSecond	2012	literature
Eric Carlson	Aaccino	2012	music
Eric Carlson	All Tetrads in The Art of the Fugue	2012	music
kogonada	Tarantino // From Below	2012	supercut
kogonada	Wes Anderson // From Above	2012	supercut

John Lely	Doubles	2012	music
Luke Nickel	Reorganization	2012	music
Jeff Thompson	Computers On Law and Order	2012	net-art
thecussingchannel	2001 A Space Odyssey - Just The HAL 9000	2012	supercut
GoldenApple	The Many D'ohs of Homer Simpson (Seasons 1-20)	2012	supercut
kogonada	Kubrick // One-Point Perspective	2012	supercut
Eric Carlson	Alphabetized Winterreise	2013	music
Eric Carlson	A Chronological Survey of Haydn's Symphonic Opening Sonorities	2013	music
Kerplosh	Complete Jesse Pinkman "BITCH" Montage (Breaking Bad Seasons 1-5)	2013	supercut
Ramsey Nasser	@everyunicode	2013	net art
Ramsey Nasser	Tweeting Top Gun	2013	net art
Mika Taanila	My Silence	2013	supercut
Jeff Thompson	Every Possible Photograph	2013	installation
Anton Wasiljew	Das Kapital Study	2013	net art
%20	AARRSSTW-WTSSRRAA	2013	video
Tom 7	ARST ARSW	2014	net-art
Eric Carlson	Beethoven op. 131 mvt 1 Without Rests	2014	music
Check TVine	James Hetfield "Yeah!" Compilation	2014	music
Steve Gisby	Fragmented Melodies	2014	music
kogonada	Wes Anderson // Centered	2014	supercut
David Pocknee	Plastic Cup Permutations	2014	music
Terence Klex	Some Things We Should Never Speak Of	2014	music
Michael Oesterle	All Words	2014	music
Mostly Other People Do The Killing	Blue	2014	music
David Pocknee	Fluxus-Style One-Word Verb Pieces	2014	net art
Tom 7	Portmantout: A portmanteau of Every English word	2015	net art
Robert Blatt	Forty-Three Thousand Five Hundred and Eleven	2015	music
Eric Carlson	At C (Every Middle C from Tristan und Isolde)	2015	music
Beavan Flanagan	2 Part Inventions	2015	music
Dylan Marron	Every Single Word Spoken by a Person of Color in [Mainstream Film Title]	2015	net art
Paul Marshall	How Shall We End This?	2015	music
mewlist	Every "Fuck" from Every Tarantino Film	2015	supercut
David Pocknee	Almost Every	2015	music
David Pocknee	Chord Catalogue (Redux)	2015	music
Labeouf, Rönkkö & Turner	#ALLMYMOVIES	2015	net art
Matt Bucy	Of Oz the Wizard	2016	net art
Ed Henderson	Jurg Frey's String Quartet No. 3 With The Music Taken Out	2016	sound art
Maurice Rougeux	Between The Words	2016	visual art

Chapter 3 Bibliography

- %20. 2013. "AARRSSTW-WTSSRRAA." Visited on 01/01/2016. <http://noneinc.com/AARRSSTW-WTSSRRAA/AARRSSTW-WTSSRRAA.html>.
- 7, Tom. 2015. "ARST AWSW." Visited on 01/01/2016. <https://www.youtube.com/watch?v=5GFW-eEWXlc>.
- Abram, John. n.d. "Vinyl Mine." Visited on 03/29/2016. <http://www.johnabram.net/vinyl-mine.html>.
- Adrian, Philipp. 2010. Visited on 12/11/2015. <http://www.philippadrian.com/project/index-5/>.
- aKeenerCat. 2011. "Catherine Keener Tribute - Part 1: The Art of Cursing." Visited on 03/29/2016. <https://www.youtube.com/watch?v=hyv3swoMW88>.
- Arcangel, Cory. 2009. "Drei Klavierstucke op. 11." Visited on 01/02/2016. <http://www.coryarcangel.com/things-i-made/2009-003-dreiklavierstucke-op-11>.
- . 2011. "Paganini Caprice No. 5." Visited on 01/02/2016. <http://www.coryarcangel.com/things-i-made/2011-022-paganini-caprice-no-5/>.
- Auerbach, Tauba. 2011. "RGB Colorspace Atlas." Visited on 01/01/2016. <http://taubaauerbach.com/view.php?id=286>.
- Austin, Thomas. 2006. "A Never-Ending Flashback." *New Review of Film and Television Studies* 4 (2): 131–146.
- Baio, Andy. 2008. "Fanboy Supercuts, Obsessive Video Montages." Visited on 03/29/2016. http://waxy.org/2008/04/fanboy_supercuts_obsessive_video_montages/.
- Bajohr, Hannes. 2014. "Let it write: Contemporary Literature and the Fear of the Digital." Visited on 03/29/2016. <http://0x0a.li/en/schreibenlassen-gegenwartsliteratur-und-die-furcht-vorm-digitalen/>.
- Beckett, S. 1984. "Quad." In *Collected Shorter Plays*, 291–294. London: Faber / Faber.
- Bellos, David. 2012. "George Perec's Thinking Machines." In *Mainframe Experimentalism*, 38–50. London: University of California Press.
- Berkowitz, Joe. 2013. "A Modern Genre: How To Make A Supercut." Visited on 03/29/2016. <http://www.fastcocrete.com/1682740/a-modern-genre-how-to-make-a-supercut>.
- Blume, P. 2008. "Mathias Spahlinger's 128 erfulte augenblicke and the Parameters of Listening." *Contemporary Music Review* 27:625–642.
- Bod, Rens. 2002. "A General Parsing Model for Music and Language." In *Music and Artificial Intelligence*, ed. by Christina Anagnostopoulou, Miguel Ferrand, and Alan Smaill, 5–17. London: Springer.
- Bok, C. 2001. *Eunoia*. n.p.: Coach House Books.
- Boogert, A. 1692. "Traité des couleurs servant à la peinture à l'eau." Visited on 12/07/2015. <http://www.e-corpus.org/notices/102464/gallery/>.
- Borges, Jorge Louis. 1993. "The Library of Babel." In *Ficciones*, 58–66. London: Everyman's Library.
- Brett, G. 2003. "Gysin Known and Unkown: The Calligraphic Paintings." In *Brion Gysin: Tuning in to the Multimedia Age*, 51–98. London: Thames & Hudson Ltd.
- Brown, Derren. 2006. *Tricks of the Mind*. London: Random House.

- Brownlee, J. n.d. "This Designer Turned A Year's Worth Of Emotions Into Colorful Spectrums." Visited on 01/07/2016. CIASUDHISUDHAISUDHA.
- Cage, J. 2009. *Silence*. London: Marion Boyars.
- channel, richfofo's. 2009. "No Signal (and other cellular drama)." Visited on 03/29/2016. <https://www.youtube.com/watch?v=XIZVcRccCx0>.
- Clayton, L. 2010. "Qaeda, Quality, Question, Quickly, Quietly, Quiet. Wag's Revue, Issue 7. Fall 2010." Visited on 01/01/2016. http://wagsrevue.com/Issue_7/.
- Cohen, David. 1974. "Anton Webern and the Magic Square." *Perspectives of New Music* 13 (1): 213–215.
- Collins, N. 2012. "Enumeration of Chord Sequences." Visited on 01/16/2016. asdasdasdasd.
- Conrad, T. 2012. "Selected Pieces from 1961 Compositions." In *Word Events*, ed. by J. Lely J. Saunders, 161. London: Continuum.
- Cramer, F. 2005. *Words Made Flesh*. Rotterdam: Piet Zwart Institute.
- Curry, Patrick. 2010. "Embodiment, Alterity and Agency: Negotiating Antinomies in Divination." In *Divination: Perspectives for a New Millenium*, ed. by Patrick Curry, 85–118. London: Taylor / Francis.
- DeLaurenti, Christopher. 2011. "Of Silences Intemporally Sung: Luigi Nono's Fragmente-Stille, an Diotima." Visited on 03/29/2016. <https://soundcloud.com/susanlawly/christopher-de-laurenti-of>.
- Deleuze, G. 1995. "The Exhausted." *SubStance* 24:3 (78): 3–28.
- dondrapersayswhat. n.d. "Videos." Visited on 03/29/2016. <https://www.youtube.com/user/dondrapersayswhat/videos>.
- Druckner, J. 2006. "Procedures Performed and Executed." In *Make Me Think: Bruce Nauman*, ed. by Laurence Sillars, 32–45. Liverpool: Tate Liverpool.
- Dworkin, K., C. & Goldsmith. 2011. *Against Expression*. Evanston, Illinois: Northwestern University Press.
- Fincher, David. 1999. *Fight Club*.
- Friedman, M. 2000. "Construction Sites San Francisco: pp. 48-59." In *Sol Lewitt: A Retrospective*, 48–59. San Francisco: San Francisco Museum of Modern Art.
- Frye, Brian. 2001. "Rose Hobart." Visited on 03/29/2016. http://ubu.com/film/cornell_rose.html.
- Funkhauser, Christopher. 2012. "First Generation Poetry Generators: Establishing Foundations in Form." In *Mainframe Experimentalism*, 243–265. London: University of California Press.
- Giestas. n.d. "Soft Cover Emotions." Visited on 12/23/2015. <http://giestas.com>.
- Glimcher, Marc. 2005. *Logical Conclusions: 40 Years Of Rule-Based Art*. New York: Pace Wildenstein Gallery.
- Glover, Richard, and Bryn Harrison. 2013. *overcoming form: reflections on immersive listening*. Huddersfield: University of Huddersfield Press.
- GoldenApple. 2012. "The Many D'ohs of Homer Simpson (Seasons 1-20)." Visited on 12/23/2015. <https://www.youtube.com/watch?v=cnaeIAEp2pU>.
- Goldsmith, Kenneth. 2007. "Being Boring." In *American Poets in the 21st Century: The New Poetics*, ed. by Lisa Sewell Claudia Rankine, 361–367. Wesleyan: Wesleyan University Press.
- . 2011. *Uncreative Writing*. New York: Columbia University Press.
- Gottfried, Rama. 2009. "Langenscheidt Euro-Edition Teil A." <http://ramagottfried.com/dictionary.html>.
- Group, The Zaj. 2004. *A Zaj Sampler*. n.p.: ubu Classics.
- GyörgyLigeti. 1960. "Pierre Boulez." *Die Reihe* (London) 4:36–62.
- Gysin, Brion. 2001. "Back In No Time: The Brion Gysin Reader," ed. by Jason Weiss. Middletown, CT: Wesleyan University Press.
- . 2003. *Brion Gysin: Tuning in to the Multimedia Age*. London: Thames & Hudson Ltd.

- Hazelden, Maura. 2011a. "Pride & Prejudice, Movement: Past, Possible, Present." Visited on 03/29/2016. <https://www.etsy.com/listing/105313398/pride-prejudice-movement-past-possible>.
- . 2011b. "Working With Jane Austen." Visited on 03/29/2016. <http://www.yllehwnymathisplacehere.blogspot.co.uk/2011/09/working-with-jane-austen-gweithio-gyda.html>.
- Henderson, Ed. 2016. "Jurg Frey's String Quartet No. 3 With The Music Taken Out." Visited on 03/29/2016. <https://soundcloud.com/edward-henderson/jurg-freys-string-quartet-no-3-with-the-music-taken-out>.
- Higgins, Hannah B., and Douglas Kahn. 2012. *Mainframe Experimentalism*. Berkeley: University of California Press.
- Ink, Spastic. 1997. "A Wild Hare." Visited on 05/07/2016. <https://www.youtube.com/watch?v=UhP4lg28fs0>.
- Intermont, Michele, and Aileen Murphy. 2011. "An Application of Group Theory to Change Ringing." *The College Mathematics* 42 No. 3:223–228.
- IQ, Filmmaker. 2012. "Editing SCARFACE for TV." Visited on 03/29/2016. <http://filmmakeriq.com/2012/02/editing-scarface-for-tv/>.
- Jobson, Christopher. 2014. "271 Years Before Pantone, an Artist Mixed and Described Every Color Imaginable in an 800-Page Book." Visited on 12/07/2015. <http://www.thisiscolossal.com/20314/05/color-book/>.
- Johns, Charlie W. 2015. *Incompatible Ballerina and Other Essays*. Alresford: iff.
- Johnson, Tom. n.d.(a). "Found Mathematical Objects." Visited on 01/04/2015. <http://www.editions75.com/Articles/Found%20Mathematical%20objects.pdf>.
- . n.d.(b). "I Want To Find the Music, Not To Compose It." Visited on 01/04/2015. <http://www.editions75.com/Articles/I%20WANT%20TO%20FIND%20THE%20MUSIC.pdf>.
- . 1984. "Tango." Visited on 04/05/2016. http://editions75.com/EnglishPortal/index.php?option=com_content&view=article&id=125:tangon1984&catid=46:piano-and-keyboard&Itemid=88.
- . 1986. *The Chord Catalogue*. Paris: Editions 75.
- . 1999. *The Chord Catalogue*. XI Records.
- Johnston, Ron. 2006. "A most public of musical performances: the English art of change-ringing." *Geo-Journal* 65:17–31.
- Jones, Chuck. n.d. "Isolation Studies." Visited on 03/29/2016. <http://www.babygorilla.com/warehouse/art/isolation/isolations.html>.
- Kemp, Anthony E. 1996. *The Musical Temperament*. Oxford: OUP.
- Kennelty, Greg. 2015. "Every AC/DC Song Ever Has The Same Ending And We Have Proof." Visited on 03/29/2016. <http://www.metalinjection.net/av/every-acdc-song-ever-has-the-same-ending-and-we-have-proof>.
- Kerplosh. 2013. "Complete Jesse Pinkman "BITCH" Montage (Breaking Bad Seasons 1-5)." Visited on 03/29/2016. <https://www.youtube.com/watch?v=WVR476WHmR8>.
- Knowles, Alison. 2004a. *by Alison Knowles*. New York: ubuclassics.
- . 2004b. "Word Power." In *Manifestos*, 5. New York: ubuclassics.
- kogonada. 2013. "Kubrick // One-Point Perspective." Visited on 03/29/2016. <https://vimeo.com/48425421>.
- . 2012a. "Tarantino // From Below." Visited on 03/29/2016. <https://vimeo.com/37540504>.
- . 2014. "Wes Anderson // Centered." Visited on 03/29/2016. <https://vimeo.com/89302848>.
- . 2012b. "Wes Anderson // From Above." Visited on 03/29/2016. <https://vimeo.com/35870502>.
- Kyriakides, Yannis. 2004. "Wordless." Visited on 03/29/2016. <http://www.kyriakides.com/wordless.html>.

- Labeouf, Rönkö & Turner. 2015. "#ALLMYMOVIES." Visited on 01/01/2016. <http://thecampaignbook.com/projects/allmymovies/%20and%20http://newhive.com/allmymovies>.
- LACMA. 2011. "BRUCE NAUMAN'S FOR BEGINNERS ENTERS LACMA'S COLLECTION." Visited on 12/24/2015. http://www.lacma.org/sites/default/files/Nauman_pressrelease_070711.pdf.
- Lang, Stormy. 2006a. "Casino The Fucking Short Version." Visited on 03/29/2016. http://youtube.com/watch?v=3j_B-GhvPgU.
- . 2006b. "The Big Lebowski - The Fucking Short Version *featured*." Visited on 03/29/2016. https://www.youtube.com/watch?v=gU2ZgaQ_H-Y.
- Lee, Paula Young. 2014. "'Every Single Word Spoken by a Person of Color' has gone viral: Will anything in Hollywood change?" Visited on 12/11/2015. http://www.salon.com/2015/07/14/every_single_word_spoken_by_a_person_of_color_has_gone_viral_will_anything_in_hollywood_change/.
- LeWitt, Sol. 2000. *Sol LeWitt: A Retrospective*. San Francisco: San Francisco Museum of Modern Art.
- lucarelli, fosco. 2015. "Photographic Removal as Critical Practice: Marina Abramović's "Freeing the Horizon" (1973)." Visited on 05/07/2016. <http://socks-studio.com/author/admin/>.
- Marshall, Paul. 2014. "How Shall We End This?" Visited on 03/29/2016. <https://soundcloud.com/100-7-kslx/acdcend>.
- Matouzek, Jiri, and Jaroslav Nesetril. 1998. *Invitation To Discrete Mathematics*. Oxford: Clarendon Press.
- McCoy, J. & McCoy K. 2012. "Every Shot, Every Episode." Visited on 03/29/2016. <http://mccoospace.com/project/51/>.
- McCoy, Jennifer, and Kevin McCoy. 2012. "Every Anvil." Visited on 03/29/2016. <http://mccoospace.com/project/44/>.
- McDaniel, Raymond. n.d. "Affect and Autism: Kenneth Goldsmith's Reconstitution of Signal and Noise." Visited on 01/01/2016. <http://wings.buffalo.edu/epc/authors/goldsmith/mcdaniel.html>.
- McIntosh, William D., and Brandon Schmeichel. 2004. "Collectors and Collecting: A Social Psychological." *Leisure Sciences* 26:85–97.
- mewlist. 2015. "Every "Fuck" from Every Tarantino Film." Visited on 03/29/2016. <https://www.youtube.com/watch?v=R-LDKfhDD9I>.
- Mickocki, Lara. 2012. "tauba auerbach: RGB colorspace atlas. designboom." Visited on 12/07/2015. <http://www.designboom.com/art/tauba-auerbach-rgb-colorspace-atlas/>.
- Miles, Barry. 2003. "The Inventive Mind Of Brion Gysin." In *Brion Gysin: Tuning in to the Multimedia Age*, 121–139. London: Thames & Hudson Ltd.
- Mirapaul, Matthew. 1997. "In John Simon's Art, Everything Is Possible." Visited on 12/07/2015. <http://www.numeral.com/articles/041797mirapaul/041797mirapaul.html>.
- Mohr, Manfred. n.d. "Cubic Limit I." Visited on 12/07/2015. http://www.emohr.com/two_1972.html.
- MoMA. n.d. "Serial Project, I (ABCD) - Sol LeWitt." Visited on 03/29/2016. https://www.moma.org/learn/moma_learning/sol-lewitt-serial-project-i-abcd-1966.
- Montfort, Nick. 2014. "Memory Slam and Code Poetry at ITP." Visited on 03/29/2016. nickm.com/post/2014/11/memory-slam-and-code-poetry-at-ityp/.
- Nasser, Ramsey. n.d. "555μhz." Visited on 12/07/2015. <http://nas.sr/555%5C%C%5C%5C2%5C%B5hz/>.
- . 2013. "everyunicode." Visited on 12/07/2015. <http://nas.sr/everyunicode/>.
- Ngai, Sianne. 2000. "Stuplimity: Shock and Boredom in Twentieth Century Aesthetics." *Postmodern Culture* 10 (2).
- Ono, Yoko. 1964. *Grapefruit*. London: Simon / Schuster.
- Pantone. n.d. "about Pantone." Visited on 12/07/2015. <http://www.pantone.com/pages/Pantone.aspx?pg=19306>.

- Parrish, Allison. 2014. "Every Word." Visited on 01/02/2016. <http://www.decontextualize.com/2014/06/task-complete/>.
- Perec, Georges. 2009. "The Machine." *Review Of Contemporary Fiction* 29 (1): 33–93.
- Perloff, Marjorie. 2010. *Unoriginal Genius*. London: University of Chicago Press.
- Pichler, Michalis. 2009. "Un Coup de dés jamais n'abilora le hasard." Visited on 03/29/2016. https://www.youtube.com/watch?v=JkG_qAk7zxQ.
- Piringer, Jörg. 2011. "Unicode." Visited on 03/29/2016. <http://joerg.piringer.net/index.php?href=unicode/unicode.xml>.
- Lev Trotskii. 2000. In *Censorship: A World Encyclopaedia*, ed. by Derek Jones, 4:2458–2459. London: Dearborn Publishers, by Jan Plamper.
- Pocknee, David. 2015. *The Chord Catalogue (Redux)*. n.p: n.p.
- Preston, Elizabeth. 2015. "How Machines Write Poetry." Visited on 12/23/2015. <http://motherboard.vice.com/read/how-machines-write-poetry>.
- Priest, eldritch. 2011. "Listening to Nothing in Particular: Boredom and Contemporary Experimental Music." *Postmodern Culture* 21 (2).
- proteinjivesutra. 2013. "Beethoven's Eroica: opening chords." Visited on 03/29/2016. <https://www.youtube.com/watch?v=UnhlQUBsd6g>.
- Pynchon, Thomas. 1995. *Gravity's Rainbow*. London: Vantage.
- Reb, Michael Allan. 2011. "Analysis Of Variations Of Incomplete Open Cubes by Sol Lewitt. Masters Thesis." Visited on 12/07/2015. <http://krex.k-state.edu/dspace/bitstream/handle/2097/15809/MichaelReb2013.pdf?sequence=5>.
- Rorimer, Anne. 2000. "Approaches to Seriality: Sol LeWitt and His Contemporaries." In *Sol LeWitt: A Retrospective*, 60–71. San Francisco: San Francisco Museum of Modern Art.
- Rundell, Michael, and Penny Stock. 1992. "The Corpus Revolution." *English Today* 8 (3): 21–32.
- Rutherford-Johnson, Tim. 2015. "Michael Oesterle: all words The Rambler." Visited on 12/23/2015. <https://johnsonsrambler.wordpress.com/2015/10/20/michael-oesterle-all-words/>.
- Schellinx, Harold. 2014. "The Eerie Symmetry of a Perfect Ping." Visited on 12/24/2015. <http://www.harsmedia.com/SoundBlog/Archief/00814.php>.
- Service, Language Removal. n.d. "Strangers On A Train." Visited on 03/29/2016. http://languageremoval.com/projects/strangers_on_a_train.php.
- Simon, John. 1997. "Every Icon." Visited on 12/07/2015. <http://www.numeral.com/eicon.html>.
- skywalkerpotter21. 2007. "Shia LaBeouf in "No No No NOo" video." Visited on 03/29/2016. <https://www.youtube.com/watch?v=8IXCK1EyP4s>.
- Slacktory. 2012. "I'll Call You Back." Visited on 03/29/2016. <https://www.youtube.com/watch?v=0-YxlySHtE8>.
- Spencer, Ruth. 2014. "Creator of @everyword explains the life and death of a Twitter experiment." Visited on 12/11/2015. <http://www.theguardian.com/culture/2014/jun/04/everyword-twitter-ends-adam-parrish-english-language>.
- stewmurray47. 2006. "CSI Miami - Endless Caruso One Liners." Visited on 03/29/2016. https://www.youtube.com/watch?v=_sarYH0z948.
- Stinson, Elizabeth. 2016. "Between The Words." Visited on 03/29/2016. <http://www.wired.com/2016/01/heres-what-classic-books-look-like-without-words/%5C#slide-10>.
- Tate. n.d. "Catalogue entry T03116 CAMERA RECORDING ITS OWN CONDITION (7 APERTURES, 10 SPEEDS, 2 MIRRORS) 1971." Visited on 12/07/2015. <http://www.tate.org.uk/art/artworks/hilliard-camera-recording-its-own-condition-7-apertures-10-speeds-2-mirrors-t03116/text-catalogue-entry>.
- thecussingchannel. 2012. "2001 A Space Odyssey - Just The HAL 9000." Visited on 03/29/2016. <https://www.youtube.com/watch?v=Be8Gbqdox68>.

- Thomas, Philip. n.d. "The Solo Piano Music of Christian Wolff." Visited on 12/11/2015. http://www.philip-thomas.co.uk/writings/programme_notes_Wolff.doc.
- Thompson, Jeff. n.d.(a). "Computers On Law And Order: About This Project." Visited on 03/29/2016. <http://computersonlawandorder.tumblr.com/about>.
- . 2004. *Computers On Law & Order*. n.p.: <http://computersonlawandorder.tumblr.com/>.
- . n.d.(b). "Every Possible Photograph." Visited on 07/12/2015. <http://jeffreythompson.org/every-possible-photograph.php>.
- TVine, Check. 2014. "James Hetfield "Yeah!" Compilation." Visited on 03/29/2016. <https://www.youtube.com/watch?v=1KccfZCojTY>.
- tylercreviston. 2009. "Kramer's Entrance." Visited on 02/01/2016. <https://www.youtube.com/watch?v=XXSGV5wEv1o>.
- unknown. 2006. "Scarface F Word." Visited on 03/29/2016. <https://www.youtube.com/watch?v=Ft07LYRjFwM>.
- vdb. n.d. "Strain Andromeda The Video Data Bank." Visited on 01/02/2016. <http://www.vdb.org/titles/strain-andromeda>.
- Webern, Anton. 1963. *The Path to the New Music*. London: Universal Edition.
- Wiggins, Geraint A. 2015. "Searching For Computational Creativity." Visited on 12/23/2015. https://www.cs.helsinki.fi/webfm_send/571.
- Williams, Emmett. 2004. "abeeillmmstwy." In *Manifestos*, 30. New York: ubuclassics.
- . 2013. *An Anthology of Concrete Poetry*. n.p.: Primary Information.
- . 1967. *Sweethearts*. New York: Something Else Press.
- Winter, Thomas Nelson. 1999. "Roberto Busa, S.J., and the invention of the machine-generated concordance." *Classical Bulletin* 75 (1): 3–20.
- Young, LaMonte, and Jackson Mac Low. 1963. *An Anthology of Chance Operations*. New York: La Monte Young / Jackson Mac Low.
- yukole1. 2006. "Fargo Yeah." Visited on 03/29/2016. <https://www.youtube.com/watch?v=TF3z-j8o39I>.
- zebonka. 2007. "Star Trek I - X Montage." Visited on 03/29/2016. <https://www.youtube.com/watch?v=u47EyHsgpTg>.
- Zweig, Janet. 1997. "Ars Combinatoria." *Art Journal*: 20–29.

Chapter 4

Form

This chapter was meant to be the third shortest in this thesis. But, as they say: "man plans and God laughs"; however, given the current state of the world, I'm can't say that I'm on board with His particularly dark sense of humour...

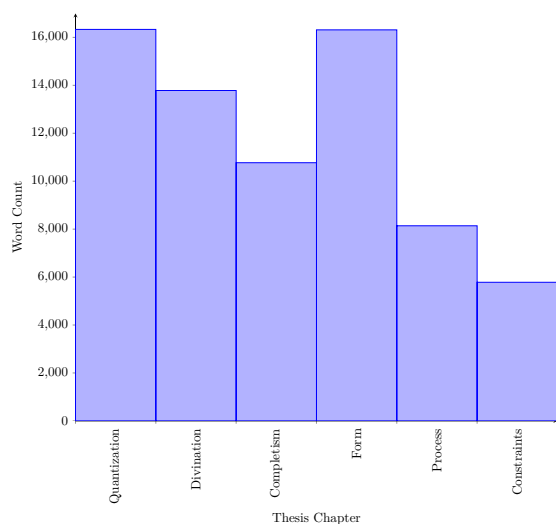

Figure 4.1: Graph showing the word count for each chapter in this thesis.

do. Which is how we got here.

The government tells us that "smokers die younger", but so did Mozart, so I know that length isn't everything, but hopefully you can see what I was trying to do in Figure 4.1, which shows the word count for each chapter in this thesis. The original plan was that these should gradually and linearly decrease over the course of the document. As can be seen, this pattern is in operation with the exception of this chapter, which is now the longest.

But how did it go so wrong? How did this chapter get so long? I had one aim when I started it: read some books on musical form and pull out some already-existing off-the-shelf typology to describe the forms that I use (which are neither new, nor complex). However, none of the musicology I found was up to the challenge and, in fact, it turned out that research on form in music written after 1900 in the classical tradition was in extremely short supply. This has meant that in this chapter I have had to develop a new theory of form just to describe the simple things that I am doing in my compositions. This took a lot of words to

4.1 Contemporary Theories of Musical Form

If music is "organized sound", as Varese posits, then form is the "organized" half of that phrase. If you have one job as a composer, it is arranging things in time in an interesting order. This ordering takes place at small and large scales in a musical work, and we could describe the largest scale of ordering as *form*.

If ordering in time is a defining aspect of compositional activity, then we would presume that analysis of form would be one of the most important types of musicological investigation. It seems bizarre, then, that there are so few theories of musical form applicable to contemporary music.

I can say nothing about the musical forms used in my own work if I am not able to compare them to those used in works by others. Yet I cannot do a comparison between works if I do not have a suitable analytical framework which can extract salient formal features to compare.

After reading many books on musical form I realized the existing writing on the subject had four main problems:

1. Most theories of musical form have become theories of genre.
2. Most theories of musical form are overfitted.
3. Most theories of musical form use complex musical works rather than simple *ceteris paribus* examples to draw inferences from.
4. Most theories of musical form are focused on symptoms rather than causes.

4.1.1 Theories of Form and Theories of Genre

By the second half of the 18th Century, large-scale formal conventions could be "identified and described on the basis of what they have in common" (Bonds 2010, 270-271). It was in this period that musicologists had come to consensus around the structures of rondo, concerto movement, and sonata form (Bonds 2010, 270-271). However:

[...] as theorizing became more systematic, and writing about music both critically and historically more formulaic, categorizations of various kinds gained the upper hand, until, as Dahlhaus observed 'the theory of form was a description of genres'. As such, it was ill-equipped to confront the protracted crisis of 20th-century music and its fraught relationship to 20th-century social and political history.

(Whittall 2001, 93)

Andrea Baldini describes this genre-based approach as *categorical form* as opposed to *aural-form*, (which is grounded in perception (Baldini 2014)). The transformation of the musicology of musical form into a musicology of genre resulted in a deficiency of generalized descriptive tools. This meant that the form of any work could *only* be analyzed in relationship to an existing genre, with the most extreme example perhaps being Hepokoski and Darcy's idea of the *genre sonata*, an approach that treats sonata form as a generic rather than formal construction (Wingfield 2008, 148).

This approach of form-as-historical-genre exists in a great deal of the musicological writing (see (Cone 1968), (Cole 1969), (Macpherson 1930), (Kohs 1976), (Morris 1935), (Caplin 1998), (Tovey 1967), (Marx 1997) etc.).

The problem with a genre-based approach to musical form is that they often involve finding commonalities amongst a comparatively small dataset, and so are frequently overfitted.

4.1.2 Overfitting

In statistics, the name given to the act of mistaking noise for signal is overfitting.

Suppose that you're some sort of petty criminal and I'm your boss. I deputize you to figure out a good method for picking combination locks of the sort you might find in a middle school - maybe we want to steal everybody's lunch money. I want an approach that will give us a high probability of picking a lock anywhere and anytime. I give you three locks to practice on - a red one, a black one, and a blue one.

After experimenting with the locks for a few days, you come back and tell me that you've discovered a foolproof solution. If the lock is red, you say, the combination is 27-12-31. If it's black, use the numbers 44-14-19. And if it's blue, it's 10-3-32.

I'd tell you that you've completely failed in your mission. You've clearly figured out how to open these three particular locks. But you haven't done anything to advance our theory of lock-picking - to give us hope of picking them when we don't know the combination in advance . . . You've given me an overly specific solution to a general problem. This is overfitting, and it leads to worse predictions.

(Silver 2012, 163)

Most theories of musical form are overfitted. In other words, they propose overly specific solutions to general problems. The meaningful ordering of sound is a general problem, whereas many formal theories are tied to genre and era. This might not seem like a problem, in that it is useful to have specific tools

for solving specific problems, but it frequently leads these theories to be overfitted to the extent that they can not explain anything other than the evidence they were trained on.

A good example of overfitting can be found in the 1976 10th edition of the *Oxford Companion to Music* which claims that "as a matter of fact only about six really distinct forms have ever been in use", listing only: *Simple Binary*, *Simple Ternary*, *Compound Binary/First Movement Form/Sonata Form*, *Rondo*, *Air with Variations*, and *Fugue* (Scholes 1976, 370).

Overfitting partly explains why theories of form pre-1900 had such difficulty dealing with the music of the 20th Century. It is not so much that Classical-era and 20th/21st century compositions are different musics - they are clearly connected by a historical and stylistic lineage - but that overfitting "reduces the theory's capacity to accurately predict new data" (Schindler 2014, 67). These theories of form aren't *predictive*, so when the future came along, they couldn't assimilate it.

Temporal Predictivism is "the view that phenomena discovered after the theory predicted them count more than phenomena that were known at the time the theory was proposed" - think how Dmitri Mendeleev's *Periodic Table* was accepted by the scientific community partly because it was able to predict elements which had not been discovered yet (Schindler 2014, 62). We value a theory more when it can make successful novel predictions over its ability to accommodate known facts. And successful novel predictions "can serve as an indicator for a theory not being overfitted" (Schindler 2014, 62-67).

Most theories of musical form are accommodations of known facts. Many are only designed to describe forms which already exist. This means that they are unable to offer frameworks for anything other than the forms they have been overfitted to. For example, theories of sonata form don't facilitate the prediction of new formal types, but set up a binary condition of "sonata" or "not-sonata" accompanied by an internal division of "norms" and "deformations" (see (Wingfield 2008)). A theory which can't predict the future can't accommodate it when it arrives. This is why most concepts of musical form are unable to say anything interesting about contemporary music.

4.1.3 Drawing Inferences from Complex Phenomena

Most musicologists' approach to form: "Let's work out what steel is by studying the Large Hadron Collider".

My approach to form: "Let's work out what steel is by looking at a spoon".

If you use something as complex as a Beethoven sonata to draw inferences about musical form, it is extremely likely you are going to overfit your theory, due to the amount of complicated moving parts that allow the composition to function.

This is even a problem when more recent types of music are used to study form in the psychomusical literature. The few studies which have been done on perception of form in 20th Century music have used complex works with ambiguous formal structures (see the use of Berio and Boulez in (Deliège 1989) and the use of Xenakis, Ligeti and Leroux in (Lalitte and Bigand 2006)).

It would seem a more sensible approach to avoid overfitting would be to take music which was as simple as possible, with a limited number of independent variables, and use that as the basis for inferences.

4.1.4 Symptoms and Causes

Many theories of form are interested in the symptoms of form, not its underlying mechanisms. For instance, identifying that *Arch Form* exists is not the same as explaining the reasons for its existence, nor its place within the larger cosmology of musical ordering.

It is only when we understand the underlying mechanisms beneath surface phenomena that we can start intelligently manipulating them to our advantage. In the late 1920s and early 1930s, American physicists at Bell Labs started experimenting with semiconductors, mostly motivated by a desire to harness their abnormal electrical and physical properties. Yet it was only when this empirical stream of American experimentalism integrated the ideas of the more theoretical European physicists, such as Schrödinger and Planck, that they were able to understand *why* and *how* these phenomena were happening, which finally allowed them to control current flow across the surface of the material and create the transistor (Riordan and Hoddeson 1997).

I want to explain the *why* and *how* of *Arch Form*, not simply acknowledge that it exists - talk about causes, not symptoms.

4.1.5 My Aims

This chapter is going to put forward a new theory of musical form. Nothing fancy, it's really an extrapolated and elaborated version of James Tenney's ideas. It addresses gaps in Tenney's formulations and combats the four problems outlined above.

This theory treats form not as a genre, but concentrates on the commonalities of ordering across genres.

This theory is predictivist and not overfitted. It uses the ideas of completism to outline the entire combinatoric space of the structural and morphological components of a musical form. It puts forward an algorithm and a way of thinking that allows the enumeration of *all possible formal structures and shapes without exception*. This means that it can encompass even those which have not been used yet - it is *temporally predictive*.

This theory uses simple, *ceteris paribus*¹ examples to draw its inferences about form. I eschew the ambiguous complexity of the Classical period, from which most formal theorists draw their examples, and instead focus on Experimental Music, which contains numerous musical works with minimal independent variables (think of the simplicity and foregrounding of form in Tenney's *Having Never Written A Note For Percussion*). It is from these parametrically simplistic examples that we can start to draw inferences about form, with a minimal fear of overfitting.

Finally, this theory focuses on causes, not symptoms. Given this long, anticipation-building introduction, I can understand if you feel a little disappointment upon reaching the end of this long chapter, only to find a typology of form consisting mostly of ones you already know, such as *Arch Form* or *Moment Form*. But these forms are only symptoms. Symptoms of underlying structures, states and morphologies of which these are only the visible protuberance. The text between here and that typology gives the *causes* of these constructions and their place within a wider formal universe.

I am not interested in defining new forms, but I *am* interested in a theory which is able to accommodate not only my own forms (which are currently ill-served by the existing literature) but forms which don't even exist yet. The difference between my definition of *Arch Form* and many older ones is that whilst they might situate it within a set of previously used forms, I situate it within the combinatoric space of *all possible forms*. This means that it can not only be related to forms which *have existed* but to *all forms which can exist*, making it magnitudes more flexible and predictive.

4.2 Typologies of Narrative

I was on a *dérive* through Huddersfield University Library when, out of the corner of my eye, at the end of the shelf, I was drawn towards Robert McKee's book *Story* (1999) . . .

McKee's *Story* is about the art of screenwriting and the art of storytelling. Early on in the book, he proposes a diagram (the *Archplot* - *Miniplot* - *Antiplot* triangle in Fig. 4.2) which encompasses all possible cinematic narratives:

Although the variations of event design are innumerable, they are not without limits. The far corners of the art create a triangle of formal possibilities that maps the universe of stories. Within this triangle is the totality of writers' cosmologies, all their multitudinous visions of reality and how life is lived within it. To understand your place in this universe, study the coordinates of this map, compare them to your work-in-progress, and let them guide you to that point you share with other writers of a similar vision.

¹Literally translated from Latin: other things being equal. This means that other things which could change are for the moment being assumed to remain constant. The *ceteris paribus* assumption is made in economic reasoning to focus attention on the effect of changes in a limited set of variables of interest." (Black, Hashimzade, and Myles 2017)

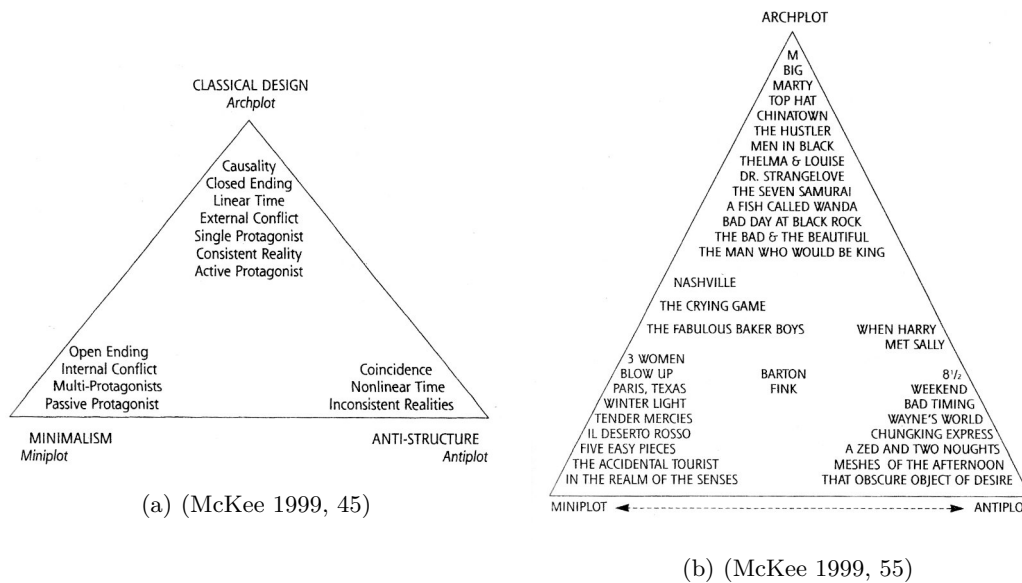

Figure 4.2: McKee's *Archplot - Miniplot - Antiplot* triangle.

Perhaps something similar could be attempted with musical form?² But why look to screenwriting pedagogy to solve musical problems?

From conversations with other composers, I have come to believe that part of the reason that discussion of form has been so neglected in Contemporary Music arises from a misplaced belief that it is impossible to discuss. This stems from the idea that form is a result, contingent upon, or an emergent property of, lower-level material and that, due to the huge differences in style and individual taste between composers, this low-level material is so disparate that the forms built upon it are too numerous to make any general statements about. I do not believe this is correct. We too could imagine a "universe of stories", a cosmology of compositions. . .

Screenwriting and composing are similar disciplines. Both involve a highly mediated process of a creative individual inscribing information into some type of notation which is then given to others to perform. Yet their pedagogical approaches are completely different. Screenwriting pedagogy tends to be top-down, focusing on form and structure over local-level detail, style and genre; while composing pedagogy tends to be bottom-up, focusing on local-level detail, style and genre over form and structure.

A good example of this can be seen by comparing Charles Wuorinen's *Simple Composition* (1979) book with McKee's *Story*. Wuorinen's book starts with teaching the reader how to build a twelve-tone row, and spends 144 pages showing how this can be used to derive local-level pitch and rhythm. Form is only discussed in the last 18 pages of this 168 page book. McKee's *Story*, on the other hand, front-loads with descriptions and typologies of form - only mentioning genre after 79 pages, and then only in relationship to structure (in the chapter *Structure and Genre* (McKee 1999, 79)).

I think that adopting some ideas from screenwriting pedagogy can help in the construction of my theory of form. I can take McKee's lead by adopting the type of large-scale thinking seen in his book and mimicking his use of geometry to create a "cosmology of possible stories".³

²It should be noted that the entirety of this chapter will only be concerned with music from the western classical/western art-music tradition that my works form a part of. Musics of other traditions will not be considered as these are sometimes rooted in paradigms of time unsuited to the type of analysis I will propose. I am primarily interested in how I can better build a framework that can explain the music that I write and the tradition it stems from, rather than creating some sort of holistic system for all musical form.

³Literary theory has an entire sub-field entitled *narratology* which is dedicated to understanding the formal construction of narrative, and to which several journals are dedicated (*Journal of Narrative Technique*, *Journal of Narrative Theory*).

James Tenney's Ideas On Form

The composer James Tenney is one of the few writers who has tried to develop the type of top-down theory of form similar to those found in the screenwriting literature. His genre-ambivalent, non-overfitted approach, seen in the texts *Meta + Hodos* (1961), *META Meta + Hodos* (1975), *Form in Twentieth-Century Music* (1969-70) and *Hierarchical Temporal Gestalt Perception in Music: A Metric Space Model* (with Larry Polansky) (1978-80) (Tenney 2015), lends itself well to the study of Contemporary Music.

Tenney's writing on form sought to build a model of musical formal perception based on gestalt psychology, embodied in the concept of *Temporal Gestalts*:⁴

... for the musician, a piece of music does not consist merely of an inarticulate stream of elementary sounds but a hierarchically ordered network of sounds, motives, phrases, passages, sections, movements, etc. - i.e., time-spans whose *perceptual* boundaries are largely determined by the nature of the sounds and sound-configurations occurring within them. What is involved ... is a conception of distinct spans of time at several hierarchical levels, each of which is both internally cohesive and externally segregated from comparable time-spans immediately preceding and following it. Such time-spans (and the events or processes that define them) will here be called *temporal gestalt-units* (or TGs).

- James Tenney and Larry Polansky *Hierarchical Temporal Gestalt Perception in Music* (Tenney 2015, 201)

At the smallest phenomenological level, a Temporal Gestalt is referred to as an *element*, groups of which then form higher-level TGs known as *clangs*, which in turn group together to form *sequences*, which then chunk together to form an indefinite number of hierarchical levels, eventually forming a Temporal Gestalt at the highest level which is the piece itself. As *element* is defined as the smallest phenomenologically indivisible gestalt, anything at a lower-level hierarchy (i.e. perceptually indivisible) is ignored as an *infra-formal* area not useful for the study of form, while a post-*piece* hierarchical level is referred to as *ultra-formal* and is similarly ignored. This type of hierarchical, gestalt-based grouping is what might, in the current psychological literature, be referred to as *chunking*.

Importantly, Tenney's idea grounds a theory of form in a study of its perceptible features, marking it out as a type of *aural form*, following Baldini (Baldini 2014). Rather than a focus on mathematical or theoretical abstraction, temporal gestalts are related to the phenomenological process of hearing.

Table 4.1 shows Tenney's hierarchy of form (adapted from various writings in (Tenney 2015)), along with similar types of temporal division found in Curtis Roads *Microsound* (Roads 2004, 1-40) and McKee's *Story* (McKee 1999, 31-42).

Tenney's views on form changed over the years - most notably between *Meta-Hodos* and *Form in Twentieth-Century Music*, which present slightly different views on the way in which hierarchical levels are created - yet one thing is consistent between both: the idea that form consists of three elements: *Shape* (morphology), *Structure* (structural) and *State* (statistical):

- **SHAPE (MORPHOLOGY):** "contour, the variation of some attribute of a thing in space or time ... In music, shape is the result of changes in some attribute or parameter of sound." (Tenney 2015, 150) "... a more superficial (i.e., pertaining to "surface") or *external* aspect of form (relating to profile or contour)" (Tenney 2015, 63)
- **STRUCTURE (STRUCTURAL):** "the disposition of parts, relations of part to part, and of part to whole ... structure has to do with various relations between sounds and sound-configurations, at the same or at different moments in time." (Tenney 2015, 150) "... usually refers to an *internal* aspect, "connections" or interrelations among component parts that (interrelations) are not necessarily apparent "on the surface" of the form - i.e., in its *shape*." (Tenney 2015, 63)

There is no musical equivalent to this field, so I will also be borrowing liberally from it in building up my theory of musical form, as I think it offers much to learn from.

⁴In literary narratology, similar types of gestalt thinking can be found in ideas such as David S. Miall's *episode*; *sentence*, *discursive* and *narrative topics* in Umberto Eco; *sequences* in Roland Barthes and Roman Ingarden; and *gestalts* specifically in Wolfgang Iser (Miall 2004, 114).

Curtis Roads		James Tenney		McKee
Time Scale	Description	Hierarchy	Description	Story Element
<i>Infinite</i>	The ideal time span of mathematical durations such as the infinite sine waves of classical Fourier analysis.	<i>Ultra-formal area</i>	The higher-level hierarchy larger than the form of the piece.	Life
<i>Supra</i>	A time scale beyond that of an individual composition and extending into months, years, decades and centuries.			
<i>Macro</i>	The time scale of overall musical architecture or form, measured in minutes or hours, or in extreme cases, days.	<i>Piece</i>	The number of intermediate hierarchical levels between those of the sequence and the piece is variable.	<i>Story</i>
<i>Meso</i>	Divisions of form. Grouping of sound objects into hierarchies of phrase structures of various sizes, measured in minutes or seconds.	<i>Sequence</i>	A temporal succession of two or more clangs, perceived as a larger, if looser, gestalt.	<i>Acts</i>
		<i>Clang</i>	Singular configurations of <i>elements</i> , forming units at the second hierarchical level. A TG at the lowest hierarchical level within which still-lower-level TGs are perceived. Although the clang is often equivalent to the "motive" or "phrase" of traditional musical analysis, it should be understood here to include <i>any</i> collection of sound elements perceived as a primary aural gestalt.	<i>Sequences</i> <i>Scenes</i>
<i>Sound object</i>	A basic unit of musical structure, generalizing the traditional concept of note to include complex and mutating sound events on a time scale ranging from a fraction of a second to several seconds	<i>Element</i>	The smallest "indivisible" sound units at the first hierarchical level. An element is a TG that is perceived as (temporally) <i>singular</i> , i.e. not divisible into lower-level (shorter) TGs.	<i>Beats</i>
<i>Micro</i>	Sound particles on a time scale that extends down to the threshold of auditory perception (measured in thousandths of a second or milliseconds).			
<i>Sample</i>	The atomic level of digital audio systems: individual binary samples or numerical amplitude values, one following another at a fixed time interval.	<i>Infra-formal Area</i>	The lower-level hierarchy smaller than the form of piece.	
<i>Subsample</i>	Fluctuations on a time scale too brief to be properly recorded or perceived, measured in billionths of a second (nanoseconds) or less.			
<i>Infinitesimal</i>	The ideal time span of mathematical durations such as the infinitely brief delta functions.			

Table 4.1: Table comparing temporal scales in the writings of Curtis Roads, James Tenney and Robert McKee

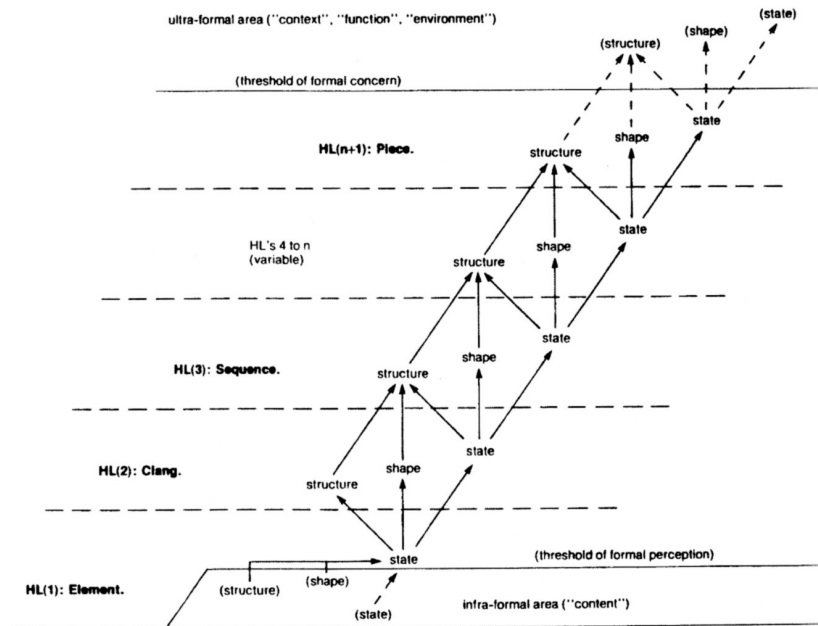

FIGURE 2. Relationships among the three aspects of form at several hierarchical levels (HLs).

Figure 4.3: Illustration of the recursive nature of the Shape/Structure/State construction, from *META Meta + Hodos* (Tenney 2015, 172).

- **STATE (STATISTICAL):** "A description of the shape (or sometimes, the structure) of a formal unit at one of these hierarchical levels frequently involves certain statistical characteristics of the formal units at the next lower level — e.g. the average value and range of each important parameter." (Tenney 2015, 151)

In other words, "[w]e thus have three aspects of form to consider at each hierarchical level: the structural (internal relations), the morphological (shape), and the statistical (state, condition)" (Tenney 2015, 151).

Tenney's conception of form is recursive and hierarchical, involving the nesting of morphological, structural and statistical elements to build larger structures. The smallest temporal gestalts then, can be grouped together into larger gestalts, which can then be grouped into larger gestalts and so on. The form which these groupings take is a function of the shape, structure and state of the gestalts on a lower hierarchical level, this can be seen in Figure 4.3.

These relations between state, shape and structure at adjacent hierarchical levels are, incidentally, relevant to the old problem of "form vs. content". A little reflection will show that the "content" of a formal unit at a given hierarchical level is determined by the structural, morphological and statistical properties — i.e. the form — of each of its component units at the next lower level. Conversely, formal properties at one hierarchical level become the "content" of formal units at the next higher level.

- James Tenney *Form in Twentieth-Century Music* (Tenney 2015, 151)

Figure 4.4 shows a diagram I have created, designed to clearly lay out Tenney's ideas about form as described in *Meta + Hodos*, *META Meta + Hodos* and *Form in Twentieth Century Music*. My theory of form makes several modifications to Tenney's approach:

1. **Filling of theoretical gaps** For instance, at the very end of the article *Form in Twentieth Century Music* Tenney lists the types of ergodic shape as "arch-form", "ramp-form?" and "(others?)". I use combinatorics to enumerate all possibilities in order to fill in these missing elements.
2. **Clear separation of the three components of form** In his writing, the distinctions between *shape*, *structure*, and *state* are frequently confusing, due to the way in which they interact. In order

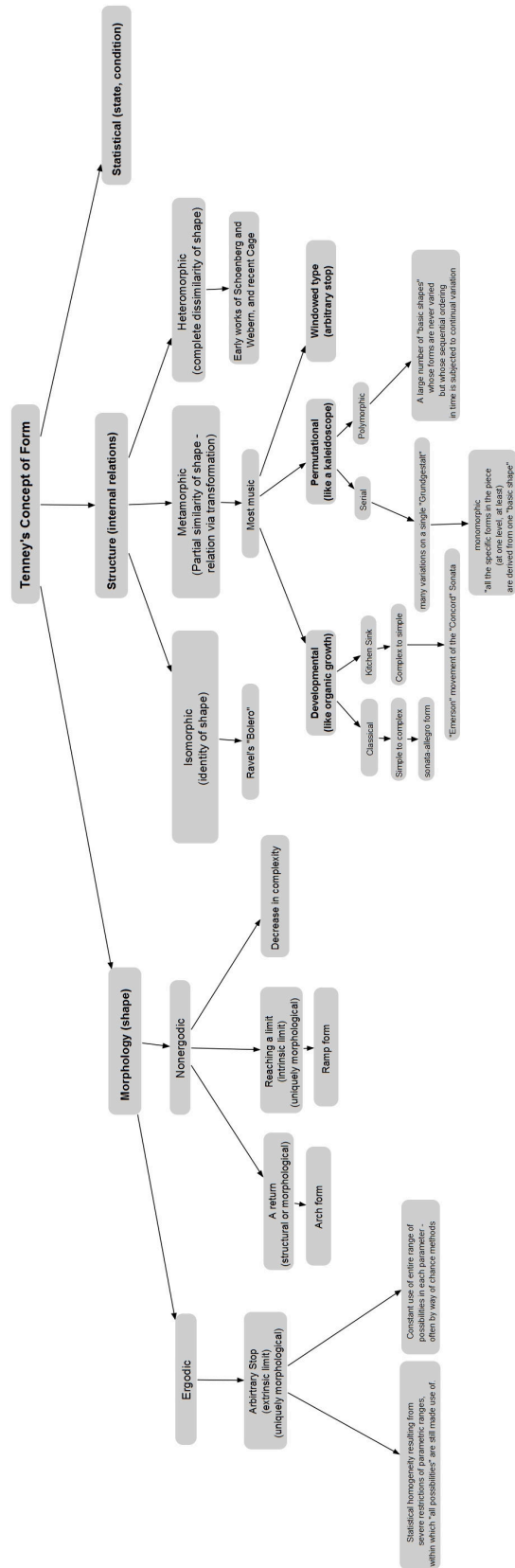

Figure 4.4: A diagram showing James Tenney's conception of form, which I created from his writings in *Meta + Hodos* and *Form in 20th Century Music*

to ameliorate this, I base each of these upon a different mathematical approach: combinatorics (structure), vectors (shape), statistics (state), and separately classify the interactions between them (*statistical morphology* etc.)

3. **Replacement of *ad hoc* classifications** Categories such as *Classical* and *Kitchen Sink* represent simple-to-complex and complex-to-simple structures, but these are really manifestations of a more general low-to-high and high-to-low parametric movement. I replace these types of classifications with exhaustive ones grounded in combinatorics. The similarly *ad hoc*, *developmental*, *permutational* and *windowed* categories are also changed.
4. **Removal of ergodic/non-ergodic and metamorphic/heteromorphic/isomorphic classifications** I use completist principles as a base for building a set of new classifications based around the topology of the combinatoric space.

My theoretical approach reworks the entirety of Tenney's formal theory from the top three categories (*shape*, *structure*, *state*) (seen in Figure 4.4) downwards. Simple applications of combinatorics, geometry, statistics and narratology allow me to propose a practical approach to formal analysis that further reifies some of the abstractions in Tenney's ideas.

4.3 A Completist Approach To Structure

Omnia probate
"Try/check all things"
(Sutton 1994, 57)

All that follows is based upon a simple assumption:

All of the music deriving from the western classical tradition is discrete.

There are no continuities in this music. This music is based upon discrete mathematics. In fact, all of its power stems from its discrete nature.

Although I use ideas of narrative from literary studies, I do not mean to propose that music is in any way a language. However, music does have similarities with language, specifically that they are both *particulate systems*:

This conceptual power [of human language] is derived from what William Abler (1989;1997) has called "the particulate principle," the idea that the unlimited diversity of structure within a given system emerges from the capacity to recombine a finite set of discrete particles or elements (atoms in chemistry, integers in our number system, and genes in genetics); the basic elements or particles in these systems have no *meaning* on their own, which is why they provide the basis for a powerful combinatorial system.

(Hauser 2000, 448-449)

Therefore, we can think of music not *as* language, but as being, similarly to language (and atoms and integers and genes), a particulate system. One important aspect of these types of systems is that it is their discrete nature which allows them to be so powerful.

In contrast, blending systems fail to provide such diversity because the elements lose their identity or integrity in the same way that white and red paint lose their identity when combined to make pink paint. Studdert-Kennedy (1998) has argued that the only way to develop a communication system with the unbounded scope or expressive power of language is by tapping into a particulate system.

(Hauser 2000, 448-449)

The musics derived from the western classical tradition involve the breaking down of complex phenomena into discrete objects (quantization). I believe this is the first fundamental act of composition, of dividing a part of the world from the chaos around it, and more importantly, it makes the world discrete such that it can be manipulated in a way which maximises an expressive power which would be absent otherwise. In fact, this may be a universal musical characteristic:

One recent cross-cultural review proposes a list of statistical universals of musical structure; specifically, these include the use of discrete pitches, octave equivalence, transposability, scales that commonly have seven or fewer pitches in unequal steps, the use of melody, pitch combination rules and motivic patterns, as well as the use of timing, duration and beat. The pitch continuum is discretized (based on culturally established musical scales), and so is the timing continuum by a process of beat induction (which establishes some kind of grid overlaying a musical sequence).

(Rohrmeier et al. 2015, 2)

4.3.1 Synoptic Letter Diagrams

My new framework for formal analysis starts at the highest possible level of the formal hierarchy. To start to understand how form gains meaning at this level, it is useful to look at the conventional ways in which it is quantized through *synoptic letter diagrams*.

A synoptic diagram is any representation of a piece which represents a *synopsis* of the work, in other words, reproducing salient elements of the work in a reduced form.

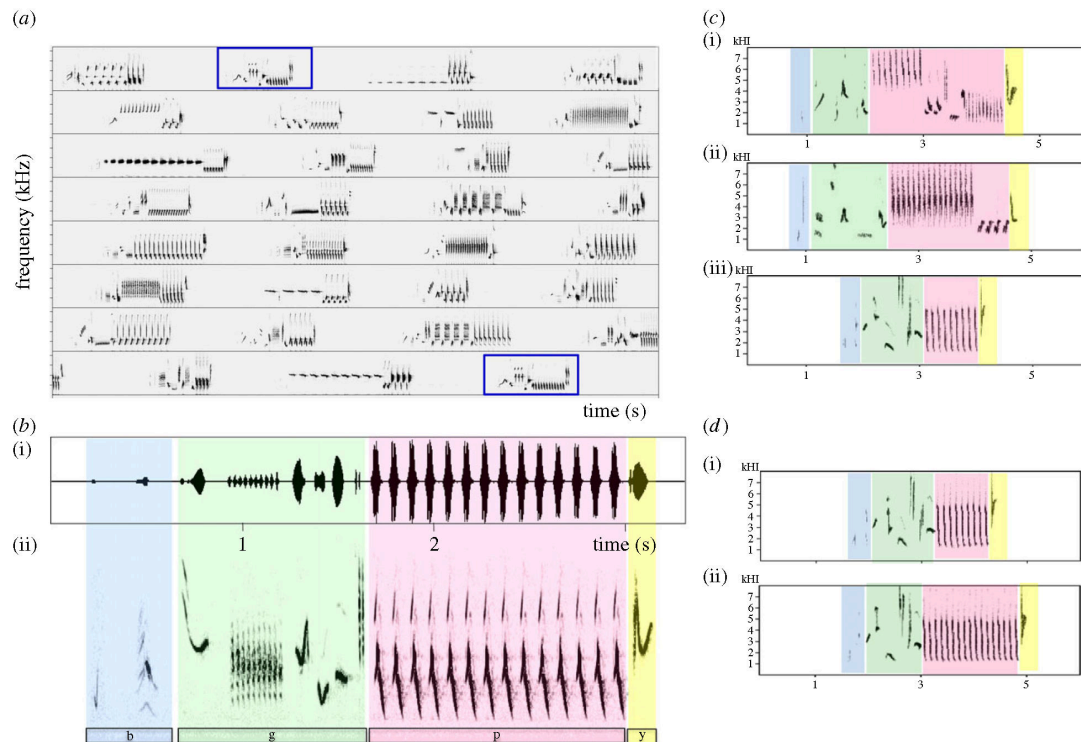

Figure 1. Hierarchical organization of nightingale song. Panel (a) depicts a spectrogram of *ca* 2 minutes of continuous nocturnal singing of a male nightingale. Shown are 30 sequentially delivered unique songs. The 31st song is the same song type as the second one (both framed). The average repertoire of a male contains about 150 unique song types, which can be delivered in variable but non-random order for hours continuously. Panel (b) illustrates the structural components of one song type. Individual sound elements are sung at different loudness (amplitude envelope in (i)) and are acoustically distinct in the frequency range, modulation, emphasis and temporal characteristics (spectrogram in (ii)). Panel (c) illustrates the structural similarities in three different song types (i,ii,iii). Song types begin usually with one or more very softly sung elements (blue, b), followed by a sequence of distinct individual elements of variable loudness (green, g). All song types contain one or more sequences of loud note repetitions (pink, p) and are usually ended by a single, acoustically distinct element (yellow, y). Panel (d) illustrates that the same song type (i,ii) can vary in the number of element repetitions in the repeated section (pink). Spectrograms courtesy of Henrike Hultsch. (Online version in colour.)

Figure 4.5: Analysis of nightingale song, showing structural divisions.

What I refer to as *synoptic letter diagrams* are those diagrams in which letters are used to create this synopsis. For instance, a *rondo form* may be represented in a synoptic letter diagram as **ABACA**. As well as letters, synoptic letter diagrams also use *prime-marks* (i.e. ') to indicate sections which are a variation on a previous section (e.g. a piece of material (**A**) followed by three variations may be notated **AA'A''A'''**).

This practice only arose at the beginning of the 20th century and, in fact, it wasn't until the early 19th Century that diagrams of any type were used to represent musical form:⁵

Not until 1825, when Antoine Reicha (1770–1836) provided diagrams to supplement his accounts of binary, ternary, and rondo forms in his *Traité de haute composition musicale*, did any critic or theorist attempt to depict musical form in an essentially spatial manner ... Reicha's efforts, moreover, found little resonance among his contemporaries. Even as simple a synoptic diagram as a series of letters—something along the lines of A B A C A, for example—would remain a rarity for another seventy-five years or so.

(Bonds 2010, 266-267)

The division of a musical work into parts is probably not only a human characteristic as similar structural divisions have been found in bird songs (see Figure 4.5).

⁵It is perhaps worthy of note that synoptic letter diagrams come into existence at the beginning of Fordism and industrial capitalism with its attendant striations of time.

Synoptic letter diagrams are often used to describe types of formal genres. A list of commonly-used, historical musical forms and their letter diagrams can be seen below:

- Strophic - **AAA ... A**
- Variation - **AA'A''A'''A'''' ...**
- Binary - **AB**
- Ternary - **ABA**
- Rondo - **ABACA**
- Arch - **ABCBA**
- Sonata Rondo - **ABACABA**
(komponist 2007) & (Scholes 1976)

An astute reader, now familiar with my compositional practice, cannot help but to now see these strings of letters not only as diagrammatic representations, but as combinatorial possibilities.

This begs the question: **AAA**, **AB**, **ABA**, **ABACA** are *some* of the possible combinations of letters that could be used to describe musical form, but what are *all* the combinations?

What would a completist approach to synoptic letter diagrams look like?

Rules for Synoptic Letter Diagrams

All synoptic letter diagrams follow a simple set of rules:

1. Each large-scale formal section in a piece of music is labelled using a letter (e.g. **A**) and an optional number of *prime* symbols (e.g. **A'**, **C''**)
2. Where a labelled section is identical to a previous section it will be assigned the same letter and prime symbols.
3. Where a labelled section is different from all previous sections it will be assigned a new letter.
4. Sections which are musically related to an existing section but are not different enough to warrant a new letter can be labelled using prime notation, with **A'** indicating a section which is a variation on **A**.
5. In all diagrams, the labelling of sections is alphabetically sequential. Therefore, the form **ABC** is possible, but not **ABD** or **CAB**.⁶
6. Due to the above rule, all diagrams *must* start with **A**.
7. Prime notation is also sequential: **AA'A''A'''** would be a form consisting of a section **A** and three different variations on it. The form **AA'A''A'** would be possible, but not **A''AA'** or **A'''A''A'A**.

The rules above are a loosely formalized algorithm for labelling a musical form using letters.

Due to the sequential, branching nature of the way in which these diagrams unfold, the potential direction of a given piece has some similarities with the way in which memory functions, specifically as it was understood by Husserl in *A Phenomenology of the Consciousness of Time* (Husserl 1999) (see Figure 4.6).

Although we have been using the word *form* to describe these synoptic letter diagrams, what we are really defining is something more specific - namely the *structure*, as Tenney understands it:

⁶It might be argued that non-alphabetically sequential structures might occur when composers are working with cut-up forms in which works are made from rearrangements of previously sequential material. However, in my usage, these diagrams only signify the similarity between two sections, *not their semiotic content*.

I have defined *structure* as involving the "interrelations among component parts," so that the existence of structure in the first place is contingent upon the existence of subordinate parts within a given gestalt. But even at the most immediate perceptual level, a thing can be resolved into parts only when there are *differences* of some kind between one point or region in the perceptual field and another. . . . if no [subordinate] parts are perceived, there can be no "interrelation of parts", and thus, no *structure* . . .

(Tenney 2015, 63)

For example, in the system of memory, the formation of a memory implies a diagonal that turns present A into representation A' in relation to the new present B, and into A'' in relation to C, etc.:

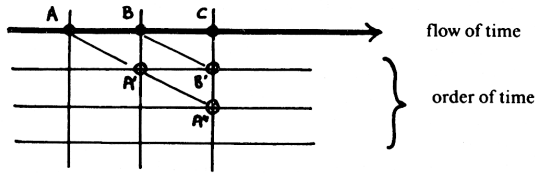

Figure 4.6: Husserl's diagram showing the progression of memory from *A Phenomenology of the Consciousness of Time* (Husserl 1999), adapted by Deleuze and Guattari in (Deleuze and Guattari 2004, 605)

Tenney also defined *Structure* in relation to the similarities of the shapes at a particular hierarchical level (Tenney 2015, 158):

1. *isomorphic*: identity of shape
2. *metamorphic*: partial similarity of shape
3. *heteromorphic*: complete dissimilarity of shape

However, there are several problems with this approach, namely that it ignores the function of structural and statistical properties upon structure. Instead, I shall be using Tenney's fundamental definition of structure as a starting point to build up a combinatorial classification system.

Tenney defines structure in the first of the quotes above as emanating from two things: (1) the number of subordinate parts and (2) their differences.

(1) Number of Subordinate Parts (Number of Sections)

The number of subordinate parts is the length of the synoptic letter diagram. I will refer to each of these subordinate parts as *sections*. The smallest, *monosectional* diagram would be **A**. A *polysectional* work such as **ABA'CA** has 5 sections.

There is no limit to the possible maximum number of sections.

(2) Differences Between Subordinate Parts (Number of Material Types)

Each section is the result of the grouping together of the shapes, structures and states of lower-levels. These three factors define the characteristics of each section and help to decide how it should be labelled, based on its similarity or difference to other sections, and its place in the chronology.

When a section is not the same as any that has occurred before it, it will be labelled using either a new letter, or an existing letter with an incremented number of prime-marks. We could describe each uniquely-labelled section as being of a different *material type*. The number of sectional material types is then the number of uniquely-labelled sections.

We can therefore think of each section labelled with a different letter as containing a different *material type* and every letter with a prime-mark as containing a material type that is phenomenologically related in some way to the material contained in the section with the same letter that has no prime-marks.⁷

We can then distinguish between two ways of counting the number of material types: *prime-exclusive* and *prime-inclusive*, where prime-exclusive involves counting only the sections labelled with a unique letter and ignoring those marked with prime-marks, while prime-inclusive treats those letters with prime-marks as separate material types. For example, Table 4.2 shows prime-inclusive and prime-exclusive counts of material types in a set of structures. We could define a structure which only uses one material

⁷This definition is specifically to account for variation forms in which relationship between two variations may have little commonality, but all variations are related to the first statement of the material.

Structure	No. of Sections	Prime-Inclusive		Prime-Exclusive	
		No. of Material Types	Material Types	No. of Material Types	Material Types
ABA'	3	3	(A,A',B)	2	(A,B)
AAAAA	5	1	(A)	1	(A)
AA'A''A'''	4	4	(A,A',A'',A''')	1	(A)
ABCD	4	4	(A,B,C,D)	4	(A,B,C,D)
ABACADA'	7	5	(A,A',B,C,D)	4	(A,B,C,D)
ABB'AA'CB''CB'''	9	7	(A,A',B,B',B'',B''',C)	3	(A,B,C)

Table 4.2: Table showing relationship between material types, sections, and structure

type as being *monotypic* and one which uses multiple material types as being *polytypic*.

Importantly, in all of these definitions, we are not interested in what any of these sections actually contain, only whether they are the same, different, or related, to each other. This means that we can make comparisons of structure irrespective of genre or style, a flexibility which is one of the reasons that synoptic letter diagrams have such widespread use in the existing musicological literature.

The Combinatorial Space of Musical Structure

We can now make a series of suppositions:

1. All music derived from the western classical music tradition is discrete.
2. The structure of all musical works derived from this tradition can be represented using synoptic letter diagrams.
3. The structures of all of these musical works can be described by two factors:
 - (a) The number of sections
 - (b) The number of different material types used (whether prime-inclusive or -exclusive)
4. The number of material types is always less than or equal to the number of sections.
5. Given these two factors, it is possible to calculate *all possible structures without exception* within a given range, up to a finite, practically-computable limit.

Appendix B shows the Ruby code for an algorithm to perform these calculations.

This algorithm was used to generate a table containing all possible structures with up to 5 sections and 5 types of material (prime-exclusive). This is shown in Figure 4.7.

In laying out all of the possibilities in this way, the exhaustive limits, size, and idiosyncrasies of this combinatorial space become clear. Specifically, there are several unique types of structures that become obvious in this particular spatial arrangement (these are also labelled in Figure 4.7):

- **Unity Structure:** At the top of the table is what I refer to as *Unity Structure*, which consists of only one section featuring one type of material (A).
- **Loop Structure:** Down the left hand side of the table is what would traditionally be referred to as *strophic form*, but which I prefer to label *loop structure*. It consists of one material type with no variations, repeated again and again (e.g. AAAAA)
- **Variation Structure:** The second column in the table is *variation* structure, in which *only* variations of a single material type (prime-exclusive) occur (e.g. AA'A''A''').

- ***n*-ary Structure:** The rightmost column of the table consists of a structure in which every subsequent section features a material type (prime-exclusive) different from all others that have occurred (e.g. **ABCD**). The name *n-ary* comes from the generalized classification used for the terms *binary*, *ternary*, *quaternary* etc. (with the added bonus that sections with a large number of section can be labelled by prefixing a number (e.g. *13-ary*)).

Whilst **AB** is a binary structure, I uncharacteristically categorize **ABC** rather than **ABA** as *ternary*. This is due to the fact that I see *n-ary structures* as an extrapolation of the logic embedded in binary structure (i.e. difference), and that **ABA** can be better classified using morphological categorizations (such as *Arch Shape*) discussed later.

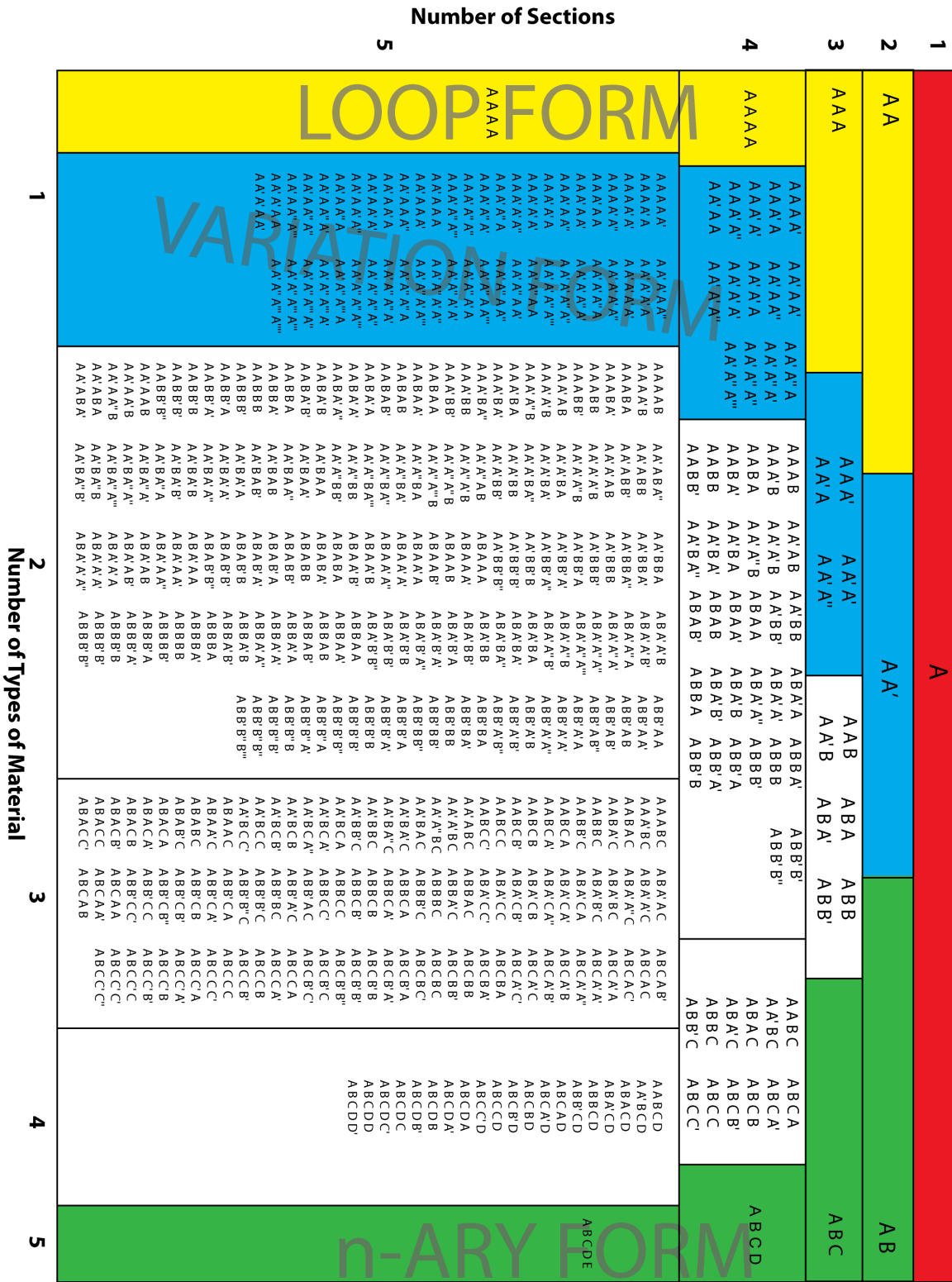

Figure 4.7: An enumeration of all possible structures up to 5 sections and 5 material types.

4.3.2 The Structural Triangle

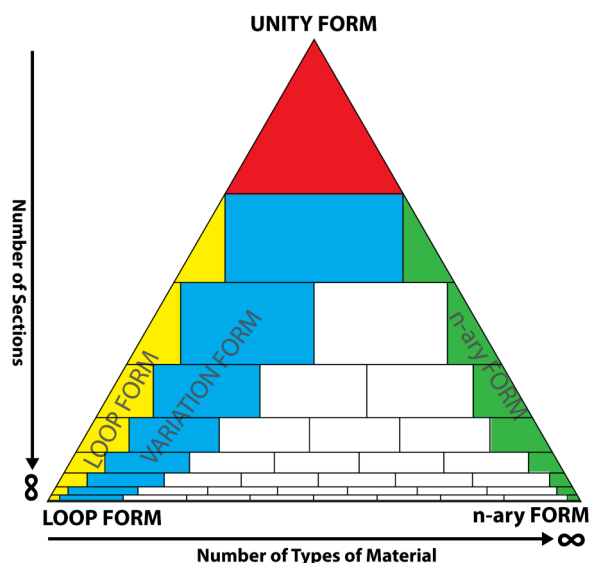

Figure 4.8: The Structural Triangle (not to scale).

combinatorial spaces, amongst the sea of mediocrity, we see thin seams of high semiotic volatility, what I refer to as *shatterbelts*:

The concept of shatterbelts originated in geopolitical writings in the early 20th century. The term ‘shatterbelt’ generally refers to a geographical region that is plagued both by local conflicts within or between states in the region, and by the involvement of competing major powers from outside the region. Shatterbelt regions are often blamed for a large proportion of interstate conflict, particularly with respect to major power conflict.

(Hensel and Diehl 1994, 33)

Just as how, in its political usage, the term describes geographical areas of statistical high interstate conflict, we might adapt this term to refer to the parts within a combinatoric space which have aesthetic characteristics with some sort of semiotic volatility that distinguishes them from the rest of the possibilities. However, shatterbelts in a combinatorial space are rare. Consider, for instance, the combinatorial space of all 479,001,600 possible twelve-tone rows and the way in which composers gravitate towards tiny and scarce shatterbelts of symmetry:

Under transposition, retrograde, and inversion, symmetric row classes constitute just 0.13% of the universe of possibilities. Yet they constitute 5% of the row classes in Schoenberg (2 of 42) and 20% of the row classes used by Webern (4 of 21). It seems clear that these composers liked symmetry. If they had chosen row classes at random, without regard to symmetry, it is improbable that either composer would have used such a large number of symmetric row classes. (For Schoenberg, the probability would be .0015; for Webern, 1.25×10^{-8} .)

(Hunter and Hippel 2003, 131)

The penchant for composers to choose rows which exhibit characteristics non-typical of the vast majority of the occupants of the combinatorial space points to the lack of interest generated by most of the objects. The topology of the structural triangle helps to reveal the non-typical structures in which those of most interest are likely to lie. Loop, n-ary, variation and unity structures are rare shatterbelts of semiotic volatility within this combinatorial space.

The table in Figure 4.7 could be extended rightwards and downwards infinitely. It shows that number of possible structures exponentially increase in relation to the number of sections and material types. This suggests that the chart should be re-shaped to account for this fact. The small number of possibilities at the top of the diagram and the large number at the bottom immediately suggest one shape: a triangle - just like the McKee example in Figure 4.2!

This *Structural Triangle* can be seen in Figure 4.8, with content removed. As can be seen, this triangle extends out to infinity in both horizontal and vertical dimensions. The *n-ary*, *variation* and *loop* structures gradually find themselves squeezed out towards the edge of the triangle.

It is conjectured that the closer you are to the centre of this triangle, the less interesting the structure is. In any combinatoric space, the vast majority of possibilities will approach the statistical average of the space. This means that any random selection from within this space is likely to be *unremarkable*. However, also, in these large

4.3.3 The *Block Structure - Interpolative Structure Pyramid*

Structure is defined and bounded using the *structural triangle*. Within this triangle are all possible structures that can be represented using synoptic letter diagrams.

When I began my PhD, I heard and saw the discreteness of the music around me. More specifically, I saw other composers aiming for continuity but doing it by relying upon methods that were fundamentally discrete, utilizing sets, integers, and discrete mathematics.

These were old methods, from older music which thought in blocks and grids. They gained any sense of continuity through interpolation - moving between fixed points. *Interpolation* is a term used in mathematics and the sciences for an approximation technique used for "finding the value of a function or measurement that lies within known values. If the values $f(x_0), f(x_1), \dots, f(x_n)$ of a function f of a variable x are known in the interval $[x_0, x_n]$, the value of $f(x)$ for a value of x inside the interval $[x_0, x_n]$ can be found by interpolation." (Law and Rennie 2015). In simpler terms, we could see drawing a straight line on a map between a starting-point and a destination as being an interpolation, in contrast to teleportation between the two places.

I thought that the thing preventing music from embracing a paradigmatic shift into purely continuous sound was that the wrong tools were being used. I thought we needed to discard discrete mathematics and embrace calculus. The minimal requirement needed for a piece of music to be discrete is for it to have an attack. So I tried to imagine a music without attack. I thought of pieces that had no beginning⁸, of Catherine Christer Hennix's *Hilbert Space Shruti Box ...*⁹.

I now realize that I was wrong. This is because all of the power of music comes from its particulate nature - it is impossible for western art-music to be continuous: only interpolative.

To compose is to quantize - to first divide up the world, then to organize it using the traditional tools of our craft: discrete mathematics. We can never speak of a Deleuzian *becoming* in music, it is never emergent, it is always between two fixed points:

One does not break with the arborescent schema, one does not reach becoming or the molecular, as long as a line is connected to two distant points, or is composed of two contiguous points. A line of becoming is not defined by points that it connects, or by points that compose it; on the contrary, it passes *between* points ... a line of becoming has neither beginning nor end, departure nor arrival, origin nor destination.

(Deleuze and Guattari 2004, 323)

There are no *becomings* in music, and to perceive music as such is to make the same mistake as when we see children as human *becomings* as opposed to human *beings* (see Qvortrup), a mode of thought that transforms them into the colonized-subjects of adulthood (Albon 2012, 161). Instead, we must accept *beingness, pace* Hubbard and its "assumption (choosing) of a category of identity" (Hubbard 1999, 21).

The Structural Pyramid

In relationship to structure, we can think of a movement between two adjacent sections as being of either a *block* or *interpolative* type. A block type movement would involve the sudden change between each sec-

⁸Any music which starts has an attack, so you would need a work which never started. In order for a work to never start, it would always have to be there, so it would be a work that lasted for the length of time the universe has been in existence. However, the universe itself has an attack: the Big Bang, so the minimal amount of attacks a work can have is 1.

⁹[SIMON DUFF:] "The whole world can be understood as just one single vibration." You said this in a recent interview. Will you explain what you mean by this?

[Catherine Christer Hennix:] I mainly intended an allusion to modern cosmology which regards the universe as a collection of oscillations. At the lower end of this wave spectrum is the Hubble frequency presently at about 3×10^{-18} Hz with a wave length the diameter of the entire universe. And at the upper end there is a cut-off frequency at about 10^{44} Hz (also known as the "Planck frequency") the wave length of which is limited by the Uncertainty Principle. Between these two extremes there is a discontinuous spectrum with zillions of frequencies of which we only know a fraction. However they all compose as a single composite wave form which may be considered as the form of the universe as such. A tiny subset of this giant 62- fold composite wave form is within hearing range and will be something we can listen to in the future. I call this abstraction The Hilbert Space Shruti Box when I draw on these frequencies as they are selected for my compositions.

- This quotation was originally available from an interview by Simon Duff titled *The Electric Harpsichord* on the *Art & Music Magazine* website at <http://artmag.saatchigallery.com> but has now been removed. The text above is sourced from a personal archive of the webpage that I made in 2013.

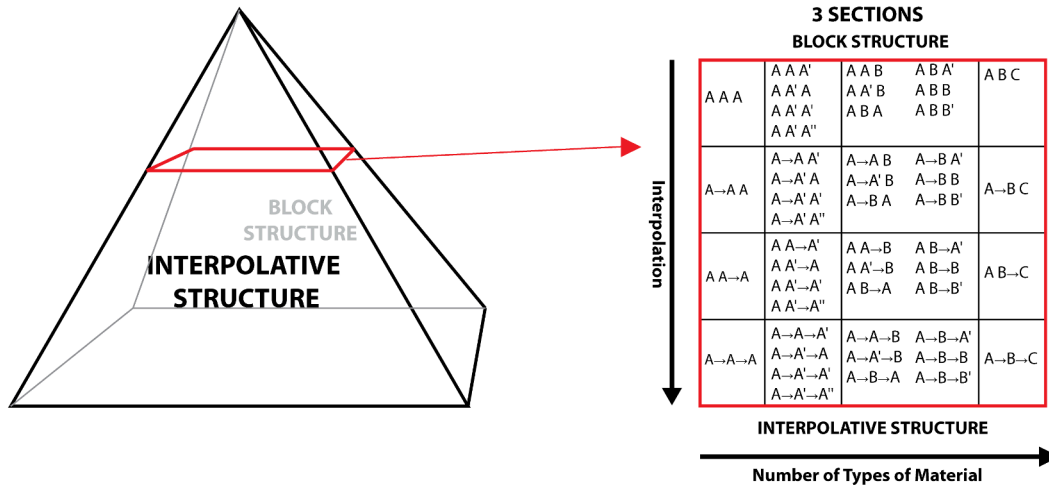

Figure 4.9: The Structural Pyramid (left) and a cross-section of the Structural Pyramid at the 3-section level.

tion, whilst an interpolative transition would involve the changing of one section into the other without a clear sectional division. There are several ways of mathematically interpolating between two points, such as linear or polynomial techniques, but these will not be dealt with here. The more important idea is how these two structural options help shape the form of the musical work.

Let us return to the structural triangle. Each of these structures shows only the relationship between sections, not the way in which the transition between each occurs. Let us consider this structural triangle as not consisting of all possible structures, but of all possible *block* structures i.e. those structures which only possess the block type of transition between sections.

We can then imagine this triangle to simply be a single 2D plane in a 3D space. More precisely we can consider it as one triangular face of a pyramid. This side of the pyramid contains all block structures. On the opposite side of the pyramid we can imagine a mirror-image of this face, containing all interpolative structures.

The *interpolative structure triangle* is based on exactly the same combinatoric system as the *block structure triangle*, only here all sections are smoothly transitioned between. We could distinguish these in the notation by using an arrow to imply an interpolation between two different sections. For instance **ABA** would be found on the *block structure* face of the pyramid and, at a corresponding point on the opposite side, the *interpolative structure* face would show **A→B→A**, meaning all of these sections are continuously transitioned between. At the top of this pyramid is *Unity Structure*, a structure the same on both *block* and *interpolative* faces, as no transition is possible due to there being only a single section.

If we imagine slicing horizontally through this structural pyramid we can see the process of transition between block and interpolative structures. This can be seen in Figure 4.9 in which we have sliced through the layer containing structures involving three sections. Here another combinatoric procedure is used to exhaust the possibilities of block and interpolative transitions internal space of the pyramid between the two faces.

Although, here I am only dealing with topmost hierarchy of organization of a musical piece, it is also possible that this technique of structural organization could be recursively nested at lower levels, just like tuplets or syntax. The structural pyramid contains all possible structures.

4.4 A Vector-Based Approach to Morphology

In Tenney's theory, *Morphology* could be broken down into *Ergodic* and *Nonergodic* forms:

...the perception of a large-formal shape that I shall call *ergodic* (borrowing a term from mathematics), which I am using to mean a process in which the statistical properties of each part at the next lower hierarchical level are the same at this (lower) level and of the whole ... Among the ergodic forms, we may further distinguish two types. In one, the statistical homogeneity is the result of the constant use of the entire range of possibilities in each parameter—often by way of chance methods, though sometimes serial methods also. In the other, the statistical homogeneity is the result of what are often severe restrictions of parametric ranges within which "all possibilities" are still made use of.

(Tenney 2015, 157)

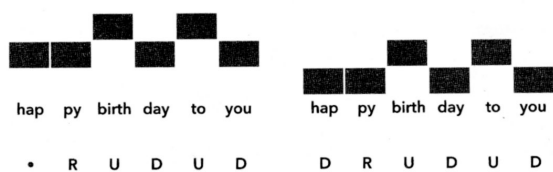

Figure 4.10: The Parsons code for *Happy Birthday* (Rudder 2014, 262)

Within these two different types, Tenney enumerates numerous subtypes and possible shapes, in an *ad hoc* way. Here, as with *structure*, I will take the basic higher-level category, ignore the lower-level classifications, and instead take a simplified mathematical approach to try and tease out a more exhaustive typology of morphological categories.

Shazam is a mobile phone application which can quickly detect the author and title of a piece of music from only a short amount of a musical recording, picked up by the phone's internal microphone.

As Christian Rudder explains in his book *Dataclysm*, this is achieved through conceiving of the entirety of recorded song as being represented by a ternary string, known as a *Parsons code*:

Shazam relies on an incredible principle: that almost any piece of music can be identified by the up/down pattern in the melody - you can ignore everything else: key, rhythm, lyrics, arrangement ... to know the song, you just need a map of the notes' rise and fall. This melodic contour is called the song's Parsons code, named after the musicologist who developed it in the 1970s. The code for the first two lines of "Happy Birthday is •RUDUDDRUDUD, with U meaning "melody up", D meaning "melody down" and R for "repeated note. The dot • just marks the beginning of the tune.

(Rudder 2014, 261-262)

Thought of in another way, a Parson's code uses *vectors* as a way to encode musical melody.

What is a vector? The school textbooks usually define a vector as 'a quantity having magnitude and direction', such as the *velocity vector* of an object moving through space. It is helpful to represent a vector as an 'arrow' attached to a point of space. But one is not supposed to think of the vector as being firmly rooted just at one point ... It is better, then, to think of a vector as an *instruction to move* ('Proceed one mile east-south-east') rather than as an arrow pointing from one fixed point to another.

(Roe 1997, 22)

The power of using vectors to encode information and their possibilities for allowing comparison between two similarly-coded elements is well showcased in *Shazam*'s accuracy. Vectors can also be useful as they encode *shape*, and thus can be used as a metric for describing the *morphology* of musical forms.

Using the structural triangle, which is populated through a combinatoric exhaustion of all possible synoptic letter diagrams, it is now possible to attempt a vector-based analysis of their morphology. I propose an idea I call *Formal Vectors*, mainly inspired by Larry Polansky's paper *Morphological Metrics* (Polansky 1996).

Imagine a synoptic letter diagram projected into 2-dimensional space, with each letter's height on the y-axis equivalent to its material type. The y-axis distance between each letter can then show the shape/morphology of the diagram, and the relationship between each section can be described using a vector. This list of integers can be described as a *morphological vector array*. An example of this can be seen in Figure 4.11.

In essence, a morphological vector array gives the direction and amount of change between two structural sections as an array of integer values. These vectors can then be used for analyzing the morphology of a given diagram in order to compare the shape of two different forms or to extract salient features of its trajectories.

For example, if we take the forms **ABA** and **AA'A**, although the sections in each are labelled differently, a vector analysis shows that they have similar properties, as their morphological vectors are both [1,-1]. This vector also indicates that they exhibit a more general morphological feature: that of an *arch* shape.

Formal vectors may also help analytical discrepancies that can occur due to the lack of strict rules for the assigning of letters to material types in synoptic letter diagrams. This often results in situations where one analyst might label a formal section as **B**, whilst another may label it as **A'**. In a morphological vector analysis, however, both of these could have the same morphological vector, allowing comparison of shape across analyses.

Comparison metrics for morphologies are extensively outlined in Polansky's *Morphological Metrics* paper (Polansky 1996).

4.4.1 Calculating Morphological Vectors

Morphological vectors are calculated using the following algorithm:

1. First enumerate all material types in the piece, ordering them first alphabetically, and then according to the primes within a material type.
e.g. **AACBB'CA'A''** would be re-ordered as **AAA'A''BB'CC**.
2. Remove any duplicates from this re-ordering.
e.g. **AAA'A''BB'CC** would become **AA'A''BB'C**.
3. This ordered set of material types is mapped to the set of natural numbers.
e.g. **{A,A',A'',B,B',C}** → {0,1,2,3,4,5,6}.
4. This mapping is then applied to the original structure.
e.g. The original structure **{A,A,C,B,B',C,A',A''}** would then be translated to its mapped equivalent in natural numbers: {0,0,6,4,5,6,2,3}.
5. The differences between each consecutive element in this set then give the morphological vectors:
e.g. {0,0,6,4,5,6,2,3}: [(0-0),(6-0),(4-6),(5-4),(6-5),(2-6),(3-2)] = [0, 6, -2, 1, 1, -4, 1]
6. Where there is interpolative movement between sections, this can be indicated through placing an arrow above the vector between the sections where the interpolation occurs.
e.g. **A→BAC→A** could be represented as $\{\vec{1}, -1, 2, \vec{-2}\}$

The code in Appendix B is also able to generate the morphological vectors for any structure that can be represented in the block structural triangle.

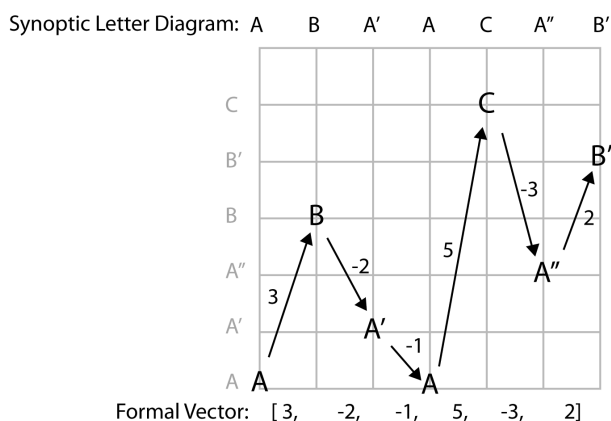

Figure 4.11: An example of the way in which a morphological vector is calculated.

Table 4.3: Table showing historical forms and their morphological vectors

	Number of Sections							General Rule
	1	2	3	4	5	6	7	
Loop		AA [0]	AAA [0,0]	AAAA [0,0,0]	AAAAA [0,0,0,0]	AAAAAA [0,0,0,0,0]	AAAAAAA [0,0,0,0,0,0]	[0,0,00]
Variation		AA' [1]	AA'A" [1,1]	AA'A"A" [1,1,1]	AA'A"A"A" [1,1,1,1]	AA'A"A"A"A" [1,1,1,1,1]	AA'A"A"A"A"A" [1,1,1,1,1,1]	[1,1,1 ...,1]
n-ary		Binary AB [1]	Ternary ABC [1,1]	4-ary ABCD [1,1,1]	5-ary ABCDE [1,1,1,1]	6-ary ABCDEF [1,1,1,1,1]	7-ary ABCDEFGFG [1,1,1,1,1,1]	[1,1,1 ...,1]
Arch			ABA [1,-1]		ABCBA [1,1,-1,-1]		ABCDCBA [1,1,1,-1,-1,-1]	[1,1,1, ... -1,-1,-1]
Rondo					ABACA [1,-1,2,-2]		ABACADA [1,-1,2,-2,3,-3]	[1,-1,2,-2,...,n,-n]
Sonata-Rondo							ABACABA [1,-1,2,-2,1,-1]	[1,-1,2,-2, ...n,-n,2,-2,1,-1]
Sonata-Allegro			ABA' [2,-1]					
Unity Form	A []							

4.4.2 Morphological Vector Types

Just as with structures, morphological vectors can be categorized. Table 4.3 shows the morphologies of a set of historical forms, mentioned at the start of the chapter, along with the general rules used for generating them.

4.5 State

Tenney talks little about *state* in his discussion of form. Primarily, *state* is seen as the statistical, "non-formal" features that "pertain rather to some general condition or state of these component materials" (Tenney 2015, 61). However, the statistical nature of a part of a work can help define a section or a morphology at a higher hierarchical level.

In *Hierarchical Temporal Gestalt Perception in Music: A Metric Space Model* (Tenney 2015), Tenney and Polansky discuss ways in which changes in state can be used for defining temporal gestalts. Here, a more operational definition of state is given:

By "state" I mean the set of average or mean values of a TG [Temporal Gestalt] (one for each parameter except time), plus its starting-time. The state of a TG might thus be compared to the "center of gravity" of an object in physical space, except that the temporal counterpart to mean parametric value is the beginning of the TG, rather than its "center."
(Tenney and Polansky 1980, 214)

In fact, in this paper, Tenney discounts both shape and structure as a way of defining a temporal gestalt, stating:

It is not yet clear what role similarities and differences of shape and structure might have in temporal gestalt perception, but it is quite clear that state-differences have virtually the same effects at the higher levels that they have at the element-level. Consequently, shape and structure play no part in the current model, but state-differences (i.e. intervals and distances) are treated essentially the same way at all hierarchical level.
(Tenney and Polansky 1980, 216)

However, it might be surmised that similarities of state across a particular time span might be part of the way in which a section in a structure is defined.

4.5.1 Probability Density Function Rhythm in Feldman's *Patterns in a Chromatic Field*

A good illustration of the power that comes with taking a statistical view of musical analysis can be seen in an approach to rhythm that I have developed called *Probability Density Function Rhythm*, or *PDF Rhythm* for short.

This approach treats rhythm not as specific temporal instances, but as the probabilistic outcome of a density function. The basic principle of this approach is as follows:

1. Take a probability density function - this can be from an existing work, or generated especially.
2. Use random sampling to select a series of time points within this function.
3. Quantize the output to a particular notation.

To illustrate this procedure, I will take the piano part seen in the opening of Morton Feldman's *Patterns In A Chromatic Field*. Feldman's late work is often seen as resistant to analysis (see (Hanninen 2004)). This is usually seen as stemming from the unpredictable rhythmic language. However, by taking a statistical approach (i.e. by ignoring the traditional musicological focus on shape and structure), we can uncover its hidden patterns.

In a previous paper, I have shown how famous composers' use of the piano keyboard tends towards a normal distribution (see Figure 4.13 and (Pocknee 2015)). This is far from the first time someone has used probability to study music and, in fact, probability density functions are already used to describe the deviations of inter-onset intervals in rhythmic playing (see Figure 4.14). However, I don't think that there has been a statistical analysis of Feldman's work, and I propose that much of its rhythmic language, which seems to confound conventional analysis, can in fact be described using a very simple set of statistical descriptors.

The first page of Morton Feldman's *Patterns In A Chromatic Field* was chosen for this type of analysis as the piano part exhibits an approach to pulse that lies between the periodic and the aperiodic,

♩ 63-66 Morton Feldman

The image shows the first page of a musical score for Morton Feldman's piece "Patterns in a Chromatic Field". The score is written for piano and consists of four systems of music. Each system has a grand staff with a treble clef on the top staff and a bass clef on the bottom staff. The music is characterized by complex, chromatic patterns and frequent changes in key signature. The first system includes dynamic markings such as *pppp* and *ppp*, and a performance instruction "no ped." with an arrow pointing to the right. The score is filled with intricate rhythmic and melodic lines, including many triplets and slurs. The copyright notice at the bottom reads "© 1981 by Universal Edition (London) Ltd."

Figure 4.12: First page of Morton Feldman's *Patterns in a Chromatic Field*.

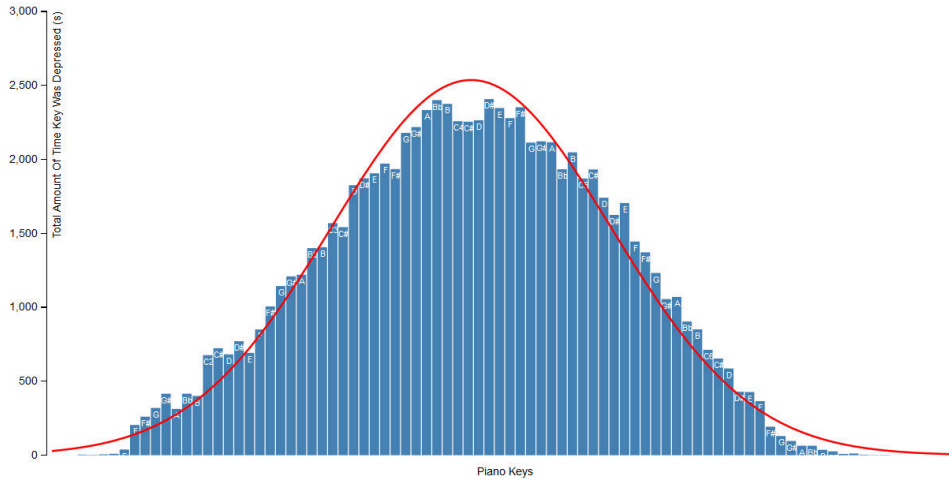

Figure 4.13: Chart showing the usage of the piano keyboard over the course of all 32 of Beethoven’s keyboard sonatas (blue bars). The red line shows a normal curve based upon the data. Each bar shows the length of time it was depressed over the course of the 32 works and have been re-adjusted to compensate for harmonic key usage (Pocknee 2015).

and thus proves difficult to analyze with traditional tools. The piano part of the first page consists of a repeated bar length, within which the same two piano chords play, one after the other, appearing at slightly different places in each new bar. They always occur rhythmically within tuplet groups of 3 or 5.

The first page of the work can be seen in Figure 4.12). I will be only focusing on the rhythm of the piano part, ignoring its pitch. The cello part is also ignored as it can be easily analyzed using the type of combinatoric approach outlined elsewhere in this thesis.

In each bar, there are essentially three events happening in the piano: The start of the first chord, the end of the first chord/start of the second chord, and the end of the second chord. As can be seen, although there is some movement in terms of the placement of these events within the bar, each bar follows a similar pattern of a short first chord directly followed by a longer second chord. A rhythmic reduction of the first page can be seen in Figure 4.15.

The length of each bar on the first page of Feldman’s work is $\frac{4}{16}$ at a tempo of between between 63 and 66bpm. I analyzed the timing in milliseconds of each of these three events in all 36 bars on the first page. In order to minimize millisecond floating-point errors, the tempo of my analysis was set to 62.5bpm, giving a bar-length of 960ms. These values can be seen in the first 4 columns of Table 4.4.

Over the 36 iterations on the first page, within each bar, each event seems to be most statistically likely to occur at particular places. We can use standard deviation to measure this statistical spread (Figure 4.16).¹⁰

The probability density functions of these events, generated using a normal distribution, can be seen in Figure 4.16.

We can use random sampling from the density functions to give probable positions within the bar of each of the three events. This resulted in the data given in the columns 5-10 in Table 4.4. Because Feldman’s score is within a notational medium, these raw results were then quantized using the same tuplet divisions that Feldman himself used: a quintuplet division with a minimum duration of a 32nd-note, giving 10 divisions of the bar, and a triplet division with a minimum of duration of a 32nd-note division, giving 12 divisions of the bar.

An algorithm performed a random sampling and quantization procedure, choosing the tuplet division with the least distortion (giving the values seen in column 11 of Table 4.4 in Table 4.4). This resulted in the music in Figure 4.17. As can be seen, this extract very closely models Feldman’s original, showing

¹⁰For ease of description I will be using standard deviation to measure these distributions, even though other measures, such as χ^2 or F-distribution may more accurately capture the skewed nature of some of these distributions.

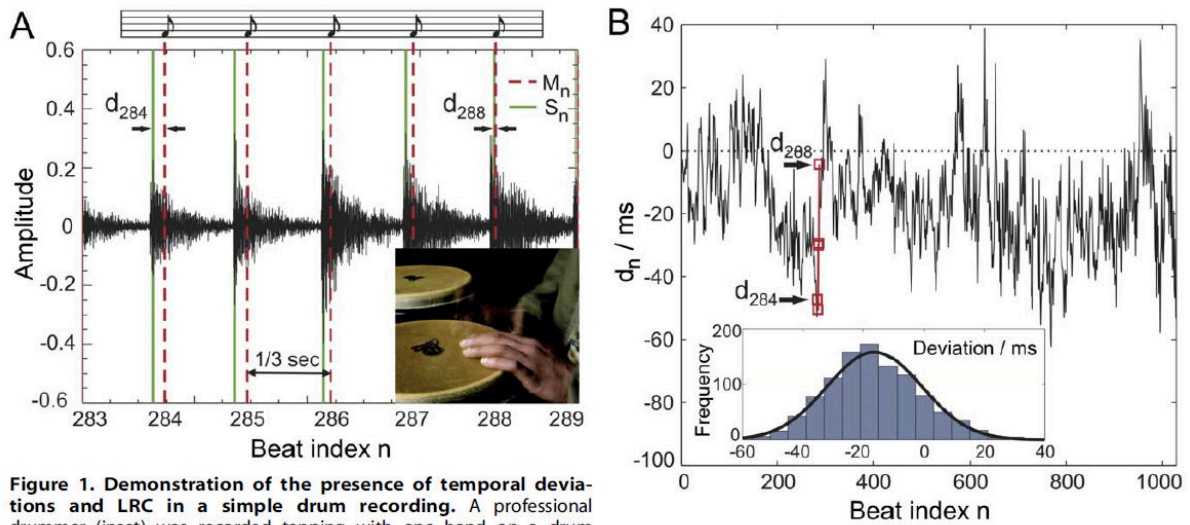

Figure 1. Demonstration of the presence of temporal deviations and LRC in a simple drum recording. A professional drummer (inset) was recorded tapping with one hand on a drum trying to synchronize with a metronome at 180 beats per minute (A). An excerpt of the recorded audio signal is shown over the beat index n at sampling rate 44.1 kHz. The beats detected at times S_n (green lines, see Methods) are compared with the metronome beats (red dashed lines). (B) The deviations $d_n = S_n - M_n$ fluctuate around a mean of -16.4 ms, i.e. on average the subject slightly anticipates the ensuing metronome clicks. Inset: The probability density function of the time series is well approximated by a Gaussian distribution (standard deviation 15.6 ms). Our main focus is on more complex rhythmic tasks, however (see Table 1). A detrended fluctuation analysis of $\{d_n\}$ is shown in Fig. 2C (middle curve).
doi:10.1371/journal.pone.0026457.g001

Figure 4.14: Diagram showing how a probability density function can describe the deviations from a fixed pulse in rhythmic playing (Hennig et al. 2011).



Figure 4.15: Rhythmic reduction of the piano part of the first page of Morton Feldman's *Patterns in a Chromatic Field*. Notes below the line represent the first chord, above the line represent the second.

Probability Density Function of Piano Chords at the beginning of Feldman's *Patterns In A Chromatic Field*

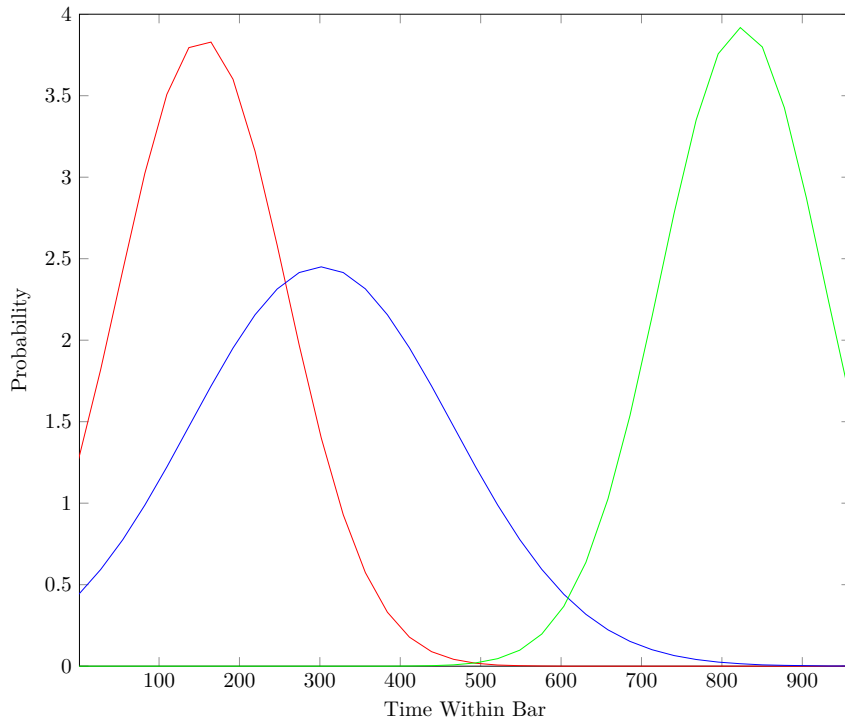

Figure 4.16: Probability Density Functions for all 3 events in the piano part of the first page of Feldman's *Patterns In A Chromatic Field*, generated using a normal distribution. Red = start of the first chord, Blue = end of the first chord/start of the second chord, Green = end of the second chord

the power and possibilities of this type of approach, not only for analysis, but for composing.

By conceiving of rhythm in this way, fluid movements between periodic and aperiodic rhythm can be smoothly done by altering the density function and its attendant attributes. With *PDF Rhythm* periodic rhythm can be conceived as rhythm with an extremely small standard deviation, whilst an aperiodic tempo can be conceived as having a large standard deviation.

A beautiful thing about standard deviation is that this curve is asymptotic, meaning that it encompasses both the infinitely long and the infinitely short, even if only at miniscule probabilities. We can therefore conceive of the probability of a beat happening at any point in time, spreading out infinitely each side of the mean which determines its probable appearance. If an algorithm with a large enough resolution was used, it is possible that, although extremely statistically unlikely, the value randomly-sampled would occur at the death of the universe.

Values in Feldman Original			Random Sample			Time in ms			Start Of 1st Chord			Start of 2nd Chord			End Of 2nd Chord				
Start of bar	1st Event	2nd Event	3rd Event	1st Event	2nd Event	3rd Event	1st Event	2nd Event	3rd Event	Beat Divi-	Time	Distortion	Pulse No.	Time	Distortion	Pulse No.	Time	Distortion	Pulse No.
0	0	94	765	0.2938	0.8532	0.1778	98	476	734	3-plet	80	1.8	1	480	4	6	730	4	9
960	319	878	910	0.2709	0.7626	0.7242	91	422	866	5-plet	96	5	1	384	38	4	864	2	9
1920	191	285	960	0.4845	0.6775	0.6804	150	381	855	3-plet	160	10	2	400	19	5	880	25	11
2880	158	319	799	0.3723	0.384	0.9127	121	262	921	5-plet	96	25	1	288	26	3	960	39	10
3840	94	191	863	0.0823	0.5176	0.2669	11	315	794	3-plet	0	11	0	720	5	4	720	34	9
4800	191	285	960	0.2572	0.1182	0.5903	87	130	854	3-plet	80	7	1	160	30	2	800	34	10
5760	319	559	799	0.1405	0.4183	0.4097	43	276	792	5-plet	0	43	0	288	12	3	768	24	8
6720	0	94	765	0.2739	0.6153	0.2695	92	355	754	5-plet	96	4	1	384	29	4	768	14	8
7680	158	398	638	0.6752	0.3924	0.3633	201	265	780	5-plet	192	9	2	288	23	3	768	12	8
8640	94	191	863	0.0456	0.618	0.6959	0	356	859	5-plet	0	859	0	384	28	4	864	5	9
9600	191	285	960	0.4837	0.4581	0.7392	150	292	870	3-plet	160	10	2	320	28	4	880	10	11
10560	319	559	799	0.0718	0.8049	0.9887	3	445	953	3-plet	0	3	0	480	35	6	960	7	12
11520	94	191	863	0.7763	0.914	0.7534	233	527	873	3-plet	240	7	3	560	33	7	880	7	11
12480	0	94	765	0.4066	0.2983	0.8481	130	226	900	5-plet	160	30	2	240	14	3	880	20	11
13440	158	398	638	0.0666	0.4716	0.0694	0	297	669	5-plet	0	0	0	288	9	3	800	3	7
14400	158	398	638	0.642	0.8434	0.2174	192	469	738	5-plet	192	0	2	480	11	5	768	30	8
15360	191	285	960	0.2718	0.7163	0.6052	91	399	837	5-plet	96	5	1	384	15	4	864	27	9
16320	319	559	799	0.0487	0.3053	0.4416	0	229	799	3-plet	0	0	0	240	11	3	800	1	10
17280	191	285	960	0.2085	0.7078	0.5763	70	395	831	3-plet	80	10	1	400	5	5	800	31	10
18240	158	398	638	0.8784	0.6829	0.671	275	384	853	5-plet	288	13	3	384	4	4	864	11	9
19200	94	191	863	0.9166	0.9306	0.5093	298	546	815	3-plet	320	22	4	560	14	7	800	15	10
20160	319	559	799	0.5179	0.6445	0.4612	159	367	804	3-plet	160	1	2	400	33	5	800	4	10
21120	0	94	765	0.3004	0.2019	0.8167	100	180	891	5-plet	96	4	1	192	12	2	864	27	9
22080	158	398	638	0.4112	0.2722	0.0053	131	214	561	3-plet	160	29	2	240	26	3	560	1	7
23040	191	285	960	0.3146	0.9642	0.5569	104	598	826	5-plet	96	8	1	576	22	6	864	38	9
24000	94	191	863	0.666	0.4919	0.3041	199	305	764	5-plet	192	7	2	288	17	3	768	4	8
24960	319	559	799	0.2923	0.2932	0.0142	98	224	598	5-plet	96	2	1	192	32	2	576	22	6
25920	0	94	765	0.2628	0.7731	0.5673	89	428	829	3-plet	80	9	1	400	28	5	800	29	10
26880	319	559	799	0.4363	0.6027	0.2041	138	350	734	5-plet	160	22	2	320	30	4	720	14	9
27840	94	191	863	0.1063	0.6936	0.9625	25	389	941	5-plet	0	25	0	384	5	4	960	19	10
28800	191	285	960	0.7221	0.5016	0.0815	215	309	663	5-plet	192	23	2	288	21	3	672	9	7
29760	191	285	960	0.1321	0.9614	0.3582	39	592	779	5-plet	0	39	0	576	16	6	768	11	8
30720	0	94	765	0.0675	0.3173	0.1692	0	234	721	3-plet	0	0	0	240	6	3	720	1	9
31680	94	191	863	0.9662	0.4834	0.2692	172	302	754	5-plet	192	20	2	288	14	3	768	14	8
32640	158	398	638	0.4628	0.8235	0.8007	145	457	886	3-plet	160	15	2	480	23	6	880	6	11
33600	94	191	863	0.3433	0.6657	0.8369	113	376	897	5-plet	96	17	1	384	8	4	864	33	9

Table 4.4: Table showing the timings of the original work and the random sampling used to create Figure 4.17.

The image displays a piano score for a piece in 16/8 time, marked with a tempo of quarter note = 63. The score is organized into four systems, each containing a grand staff (treble and bass clefs). The key signature consists of two flats (B-flat and E-flat). The music is characterized by a steady, rhythmic accompaniment. The right hand primarily plays chords, often with a triplet of eighth notes, while the left hand provides a consistent bass line with eighth notes. Measure numbers 3, 10, 19, and 28 are clearly marked at the beginning of their respective systems. The notation includes various articulations such as slurs and accents, and the piece concludes with a double bar line at the end of the fourth system.

Figure 4.17: Piano part created using using PDF Rhythmic approach.

4.6 Interactions of Shape, State and Structure

Tenney sees the construction of Temporal Gestalts on a particular hierarchical level as the result of the interactions of shape, structure and state at a lower level. We can then explode out Tenney's diagram in Figure 4.3 to show these inter-hierarchical interactions (Figure 4.18).

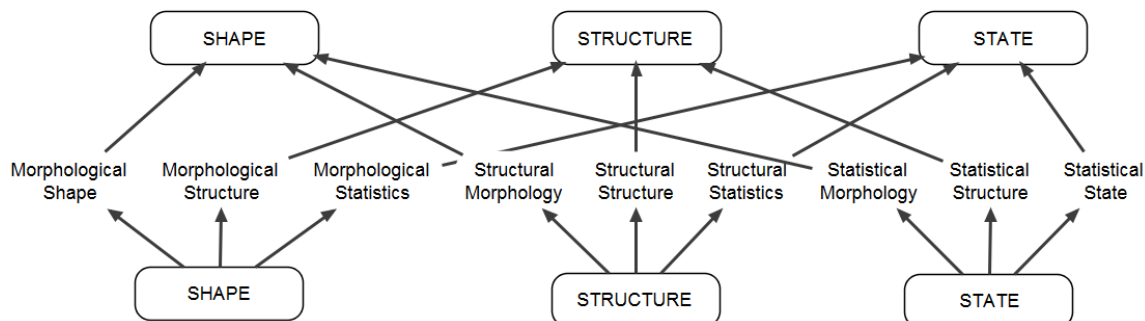

Figure 4.18: Diagram showing the interactions between shape, structure and state between one hierarchical level and the level directly above.

There are nine possible interactions. These are further elaborated in Figure 4.19, where visual illustrations of these processes are shown. I treat each of these interactions as being of potentially equal value in determining the *shape*, *structure* or *state* in the hierarchical level directly above. This labelling is not found in Tenney's work, and he sees certain of these interactions as contributing more to particular factors than others:

... shape, at a given hierarchical level, depends on statistical properties at the next lower level, while structure, at a given level, depends primarily on the morphological properties at the next lower level, secondarily on the structural and statistical properties at the next (or several) lower level(s).

- James Tenney *Form in Twentieth-Century Music* (Tenney 2015, 151)

In contrast, in my theory, each of these nine interactions has equal weighting. However, values of certain factors help to define the nature of the *shape*, *structure* or *state* more than others. For instance, structure is primarily created psychologically with a mechanism known as *Closure Positive Shift* which identifies "ending points" of sections and chunks them.¹¹ This chunking process occurs more readily with particular morphological and statistical values, as shown by Neuhaus in their study of simple ABAB and AABB structures: "Independent of form type, chunking tendencies become stronger whenever rhythmical contrast between A- and B-parts is sharp, and when melodic contours are upward-downward." (Neuhaus 2013, 122).

Most importantly, all of these interactions need not be geared towards creating the same formal result. For instance, the structure of a piece and its statistical morphology can imply different things. This can be seen most clearly by taking an example from literary analysis.

4.6.1 Shape, Structure and State in Shakespeare's *Macbeth*

Similarly to music, a distinction can be made between plot (i.e. the sequence of events - something equivalent to structure) and the statistical morphology of a narrative (i.e. the way in which a story's statistical features imply form).

A good example of this can be found in comparing two analyses of Shakespeare's *Macbeth*.

¹¹Neurological research has shown electroencephalographic evidence of a phenomena known as Closure Positive Shift (CPS) that occurs at sectional divisions and is typified by a centro-parietal positivity peaking roughly 550ms after the sectional boundaries and is interpreted as a marker of boundary perception" (Silva et al. 2014, 99).

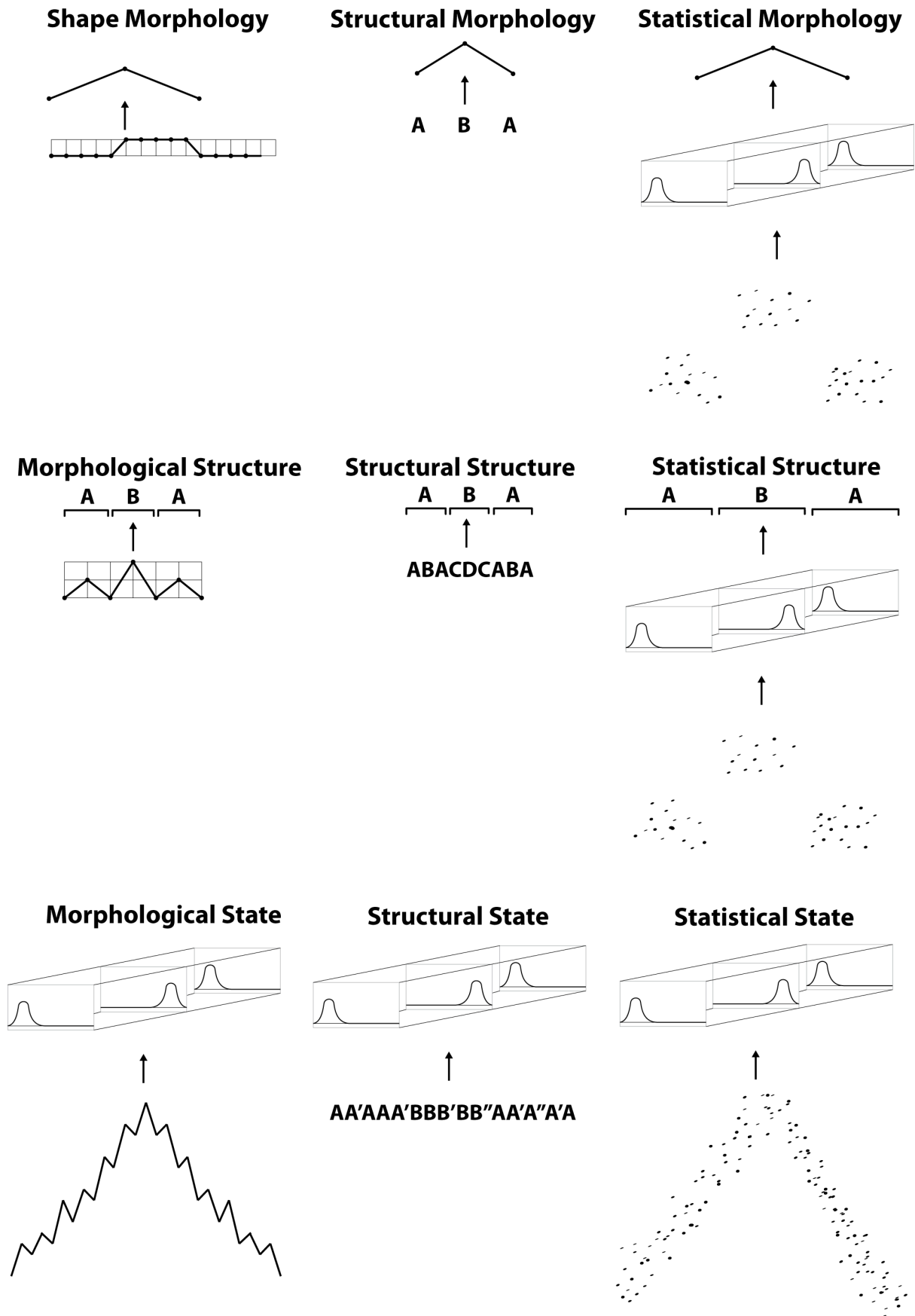

Figure 4.19: Diagram showing the interactions between shape, structure and state between one hierarchical level and the level directly above.

Christopher Booker's 2004 book *Seven Basic Plots* identifies seven different types of story structure, adding to an extensive tradition of story classification that includes Georges Polti's *Thirty-Six Dramatic Situations* (1896), Vladimir Propp's *Morphology of the Russian Folk Tale* (1928), and Joseph Campbell's *Hero With a Thousand Faces* (1949) (Adams 2008, 104).

Booker classes *Macbeth* as a *Tragedy* plot-type and, in his discussion of tragedies claims that these go through five different stages:

1. *Anticipation Stage*: the hero is in some way incomplete or unfulfilled and their thoughts are turned towards the future in hope of some unusual gratification. Some object of desire or course of action presents itself, and their energies have to find a focus.
2. *Dream Stage*: they become in some way committed to their course of action ... and for a while things go almost improbably well for the hero ...
3. *Frustration Stage*: almost imperceptibly, things begin to go wrong ...
4. *Nightmare Stage*: things are now slipping seriously out of our hero's control. They have a mounting sense of threat and despair ...
5. *Destruction or death wish Stage*: either by the forces they have aroused against themselves, or by some final act of violence which precipitates their own death (e.g., murder or suicide), the hero is destroyed. (Booker 2004, 156)

These are structural divisions and, in *Macbeth*, they correspond to the five acts of the play. This analysis stresses the importance of a 5-section *structure*, with each one having a particular characteristic.

In contrast to this structural analysis, research by Reagan et al. show a different form at work in the play. They use a technique known as *sentiment analysis*, which attempts to infer the emotional content of a text by through analyzing its vocabulary (Cambria 2016, 103).

Through mapping the amount of "happy" or "sad" words used over the course of the text, they are able to build a graph of the emotional arc of the writing:

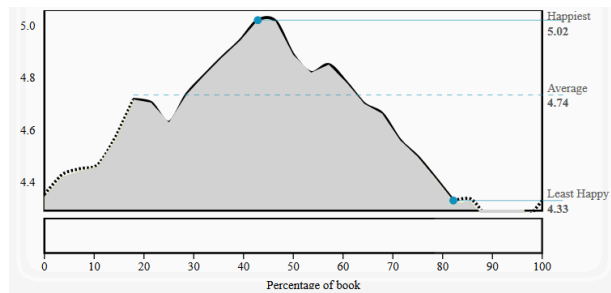

Figure 4.20: Sentiment analysis of *Macbeth*, adapted from [http://hedonometer.org/books/v1/?book=Macbeth&lens=\[3.25,7.25\]](http://hedonometer.org/books/v1/?book=Macbeth&lens=[3.25,7.25]).

The emotional arc of a story does not give us direct information about the plot or the intended meaning of the story, but rather exists as part of the whole narrative (e.g., an emotional arc showing a fall in sentiment throughout a story may arise from very different plot and structure combinations).

(Reagan et al. 2016, 1)

Reagan et al. performed sentiment analysis upon 1,737 English-language fiction books from the Project Gutenberg repository (Reagan et al. 2016). Their analysis of *Macbeth* can be seen in Figure 4.20 and, contrary to Booker's analysis, shows not a 5-part division, but a smooth movement from unhappiness to happiness and back again: an arch shape. Reagan et al. use the *statistical morphology* of a text to illuminate its form, whilst Booker uses *structure*.

It is important to note that Booker's and Reagan et al.'s analyses are not exclusive and neither invalidates the other, instead they highlight the complex interactions of shape, structure and state in the construction of form.¹²

¹²One can see something similar in the way that Christ's movement towards death on the cross is divided into seven sections of Forgiveness, Salvation, Relationship, Abandonment, Distress, Triumph and Reunion based upon his seven utterances listed in the gospels, yet the statistical movement of the body is towards death. https://en.wikipedia.org/wiki/Sayings_of_Jesus_on_the_cross.

4.6.2 Statistical Morphology and Sonata-Allegro Form

There is some precedence for using narrative to try and understand musical form. Sonata-allegro form has often been compared to the Aristotelian three act plot structure of beginning, middle and end, especially in the arguments for an "organic" approach to musical formal organisation by Shaftesbury and Baumgarten during the 18th Century (Whittall 2001, 92-93). In fact, a similar interaction between statistical morphology and structure seen in the *Macbeth* analyses above can be seen at work in *sonata-allegro* form.

Since the 1980s there has been an increasing body of psychomusicological literature dealing with the perception of large-scale musical form (see especially (Granot and Jacoby 2011a) and (Lalitte and Bigand 2006) for an overview of this research). These studies have frequently shown that both musicians and non-musicians are unable to follow large-scale formal changes, especially harmonic ones - a fact which is surprising, since this is often seen as one of the primary characteristic of the historically popular sonata-allegro form.¹³ In reviewing previous research, Granot and Jacoby state that although Western listeners, even those with no formal training have a "vast implicit knowledge about the harmonic structure of tonal music", this sensitivity is limited to local harmonic relationships with the inability to integrate these markers into an overall structure (Granot and Jacoby 2011a, 366). Research by Tillman and Bigand (2004) showed that "untrained musical listeners can easily grasp small-scale musical structures within the time span of 30s but seem completely unaware of structural change when dealing with large-scale musical forms, for instance a sonata movement." (Neuhaus 2013, 110)

Granot and Jacoby's two 2011 jigsaw-puzzle style studies ((Granot and Jacoby 2011a) and (Granot and Jacoby 2011b)) tasked musicians and non-musicians with re-ordering Classical piano sonatas which had been chopped into sections and scrambled. The two works were Mozart's piano sonata *K. 570/I in B flat major* and Haydn's piano sonata *Hob: XVI-34/I in E minor*. Both of these works are in sonata-allegro form, and the results led the authors to conclude that: "Our two studies show that if there is anything cognitively privileged about the sonata form, it is not found in its tonal design or process but rather in its overall A-B-A' organization around the non-stable and tense B section." The authors even went as far as to say that "As in previous studies, we found no evidence for integration of the harmonic information into a global structure. Therefore, the conceptually appealing idea that one can recursively apply the rules of harmonic syntax to larger and larger units may not be perceptually valid — at least for the large majority of listeners, both musically trained and untrained." (Granot and Jacoby 2011b, 79) (Granot and Jacoby 2011b, 75).

One of the most interesting elements of the discussion in these papers was the suggestion that the ability of "participants to 'recompose' structures which, although different in detail, share the general A-B-A' structure in an above chance manner" (Granot and Jacoby 2011b, 79) was due to a "convex contour of tension, proposed by a number of theorists as one important defining feature of the sonata form" (Granot and Jacoby 2011b, 75). This, and the conclusions of many of the other papers on this subject seem to imply that the perception of sonata-allegro form is based upon its *statistical morphology*, not its structure. More importantly, this statistical listening is related not to the type of specific large-scale harmonic movement proposed by researchers such as Schenker, but instead on a more general type of listening tied to general and simple categories of stable/unstable, rather than specific and complex movements between tonic/dominant movement. This research seems to show that, in sonata-allegro form, the statistical harmonic tension of a particular point in a piece is a better indicator of its formal position than its structural characteristics.

4.6.3 Wave-Shapes

One of the conclusions of Reagan et al.'s corpus-based research, was the discovery that many of the stories found in the corpus they studied had wave-shaped emotional arcs which correlated to those outlined by Kurt Vonnegut in his rejected masters thesis (Figure 4.21). These narrative wave-shapes are enumerated in Table 4.5, which also translates these into synoptic letter diagrams and morphological vectors.

¹³This is an idea which found its most extreme manifestation in Jerrold Levinson's idea of *concatenationism*, which states "that we simply hear musical sections in succession by remaining in the musical present, and that large-scale musical form has no conscious influence on the listening process at all." (Neuhaus 2013, 125) (see (Levinson 1997)).

Name	Description	Structure	Morphology
<i>Rags to riches</i> <i>Tragedy or Riches to rags</i>	rise fall	AB / A→B	[1]
<i>Man in a hole</i> <i>Icarus</i>	fall-rise rise-fall	ABA / A→B→A	[1,-1]
<i>Cinderella</i> <i>Oedipus</i>	rise-fall-rise fall-rise-fall	ABAB / A→B→A→B	[1,-1,1]

Table 4.5: Typology of story types based on Kurt Vonnegut’s rejected masters thesis (Reagan et al. 2016, 6) with corresponding structures and morphologies.

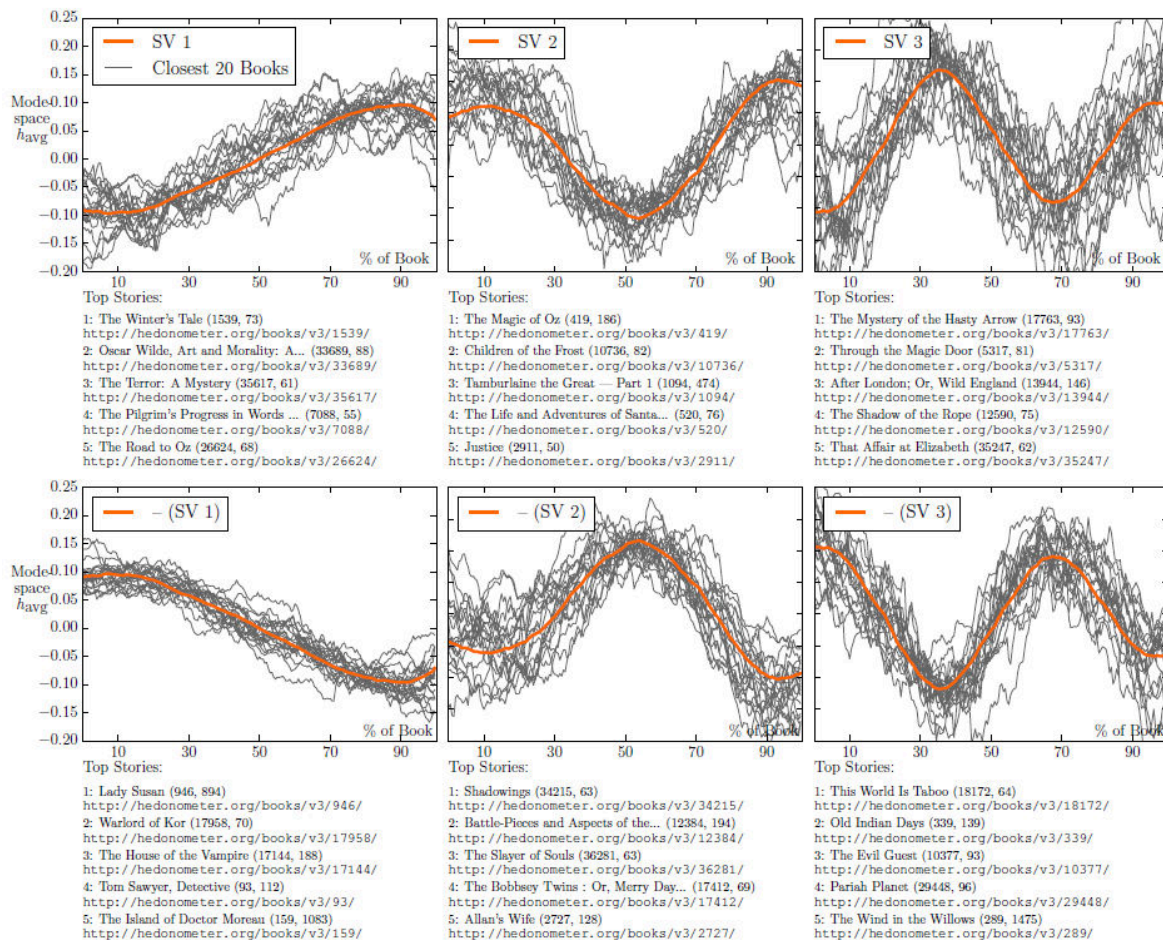

Figure 4.21: Figure from (Reagan et al. 2016): "First 3 SVD modes and their negation with the closest stories to each. . . . In parentheses for each story is the Project Gutenberg ID and the number of downloads from the Project Gutenberg website, respectively. Links below each story point to an interactive visualization on <http://hedonometer.org> which enables detailed exploration of the emotional arc for the story."

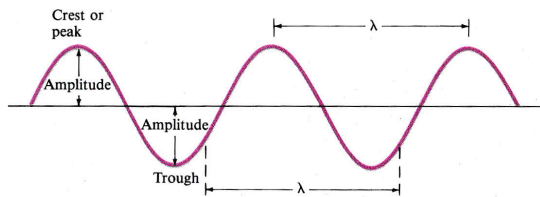

FIGURE 11-17 Characteristics of a single-frequency continuous wave.

Figure 4.22: Diagram showing the components of waves (Giancoli 1980, 288).

oblique type of narrative with similar relations between *shape*, *structure* and *state*. A good musical form is, in essence, a good story.

Given these parallels, could it be possible to explain historically-successful musical forms in relationship to the way in which they mimic the types of wave-shapes found in Reagan et al.'s study of stories?

A wave is defined by three characteristics: Its *frequency* (f), its *wavelength* (λ), and its *amplitude* (a) (see Figure 4.22). In translating these parameters into those which would be useful for studying musical form, we can propose the following mappings:

1. Frequency (f): The number of oscillations of the wave occur during the length of the form.
2. Wavelength (λ): The number of formal sections covered by one complete oscillation.
3. Amplitude (a): The number of material types covered by one complete oscillation.

In order to convert wave-shapes into morphological vectors, we will be using triangular waves, rather than sine waves. For ease of calculation, these waves oscillate between 0 and 1.

For example:

- The **ABA** form has a formal vector of [1,-1] and consists of 1 oscillation (1λ).
- The form **AB** has a formal vector of [1] and consists of half an oscillation (at amplitude 1) (0.5λ).
- The form **ABAB** has a formal vector of [1,-1,1] and consists of one-and-a-half oscillations (1.5λ).

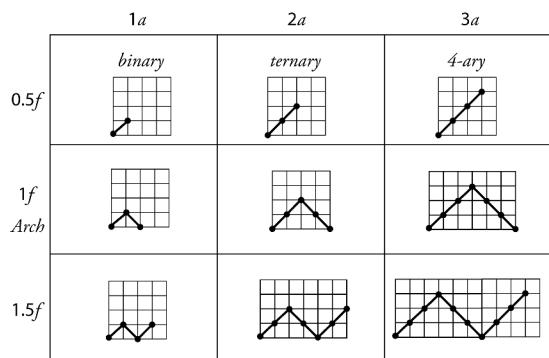

Figure 4.23: Example of how frequency and amplitude combine to create formal shapes.

Additionally, *Loop Shape* [0,0,0,...,0] can be created through either using wavelengths of infinite length ($\text{inf } \lambda$) or an amplitude of 0 ($0a$).

It appears as if wave-shapes can be used to describe the emotional arcs of many stories, and that the sonata-allegro form also owes its success to a similarly-wave-shaped convex contour of harmonic tension.

I believe that musical form is intimately connected to the forms of storytelling, and share the belief of musicologist Byron Almén, that "narrative is an archetypal practice underlying many forms of art and culture" (Hoffman 2012, 41). The process of musical form unfolding in a piece is an

Also, as part of this translation, we will only be using waves that start at 0, as all synoptic letter diagrams start at **A**, and thus, no formal vector can start with a decline. Amplitude in this context is the number of material types that the wave-shape encompasses. Here I depart from the traditional usage of the term for the height from the peak to the normal (or equilibrium) level, and instead use it to describe the height of the wave from peak to trough.

The relationship between frequency and amplitude can be seen in Figure 4.23, which shows some common formal shapes. It will be noticed that a wave with a frequency of $0.5f$ describes a *n-ary shape*, while one of $1f$ describes an *arch shape*. For our purposes, amplitude and wavelength are treated as interlinked.

4.6.4 Hybrid Wave-Shapes

Simple wave-shapes can be used for describing *Unity Shape*, all *n-ary shapes*, all *Loop Shapes* and all *Arch Shapes*.

I will now propose that all other historically successful musical morphologies can be described by the multiplication or addition of two simple wave-shapes. Figure 4.24 shows the formal possibilities that emerge from this approach, with the bottom left of the chart showing morphologies created through addition and the top right showing those created by multiplication. Remember the list of possible historical forms on page 159?: Strophic, Variation, Binary, Ternary, Rondo, Arch, Sonata Rondo. These can all be described using one wave-shape or the combination of two wave-shapes.

It can be seen in Figure 4.24 that many of the hybrid combinations do not result in canonically successful shapes. This is mostly due to the way in which the interaction of the two waves creates a result which erases key characteristics of the original.

The literary theorist Peter Brooks sees narrative as a metaphor for the conflict between the death drive and the pleasure/reality principle (Felluga 2015), seeing in Freud's *Beyond the Pleasure Principle* a dynamic model that "proposes that we live in order to die, hence that the intentionality of plot lies in its orientation toward the end even while the end must be achieved only through detour" (Brooks 1984, 108). This detour is achieved through the embodiment of the pleasure principle within the mechanism of repetition.

The death drive moves towards the ending of death, whilst the pleasure principle endlessly repeats - this interaction between narrative movement and the stasis of repetition is the key behind the most historically successful forms and I posit that music is no different. The rondo is a great example of this: the constant return to **A** (**ABACA**), coupled with the constant movement away from **A** (**ABACA**). This is why the most historically successful hybrid wave-shapes in Figure 4.24 are ones which combine one shape of movement (e.g. 0.5*f*), with one of repetition (e.g. 3*f*).

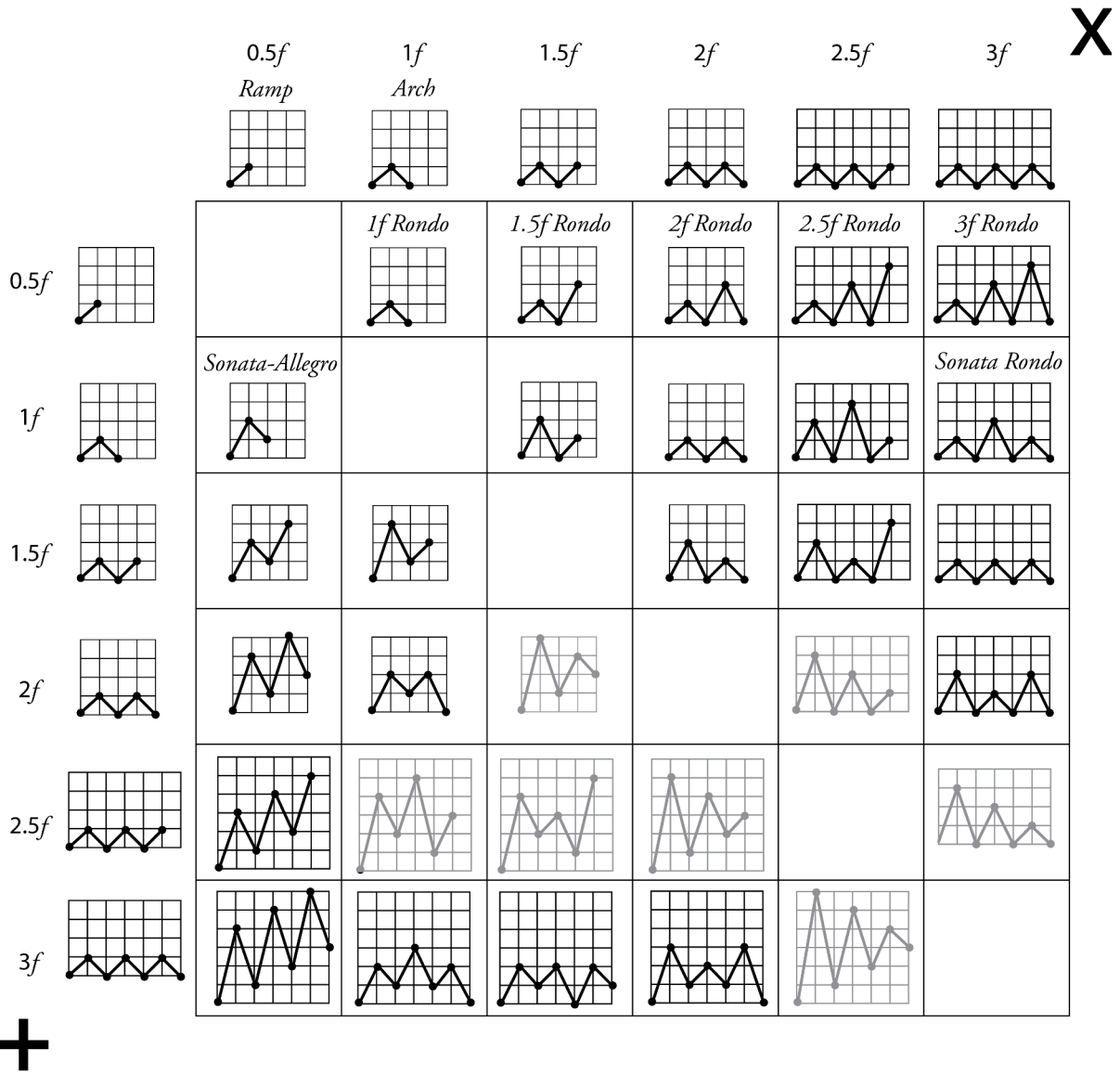

Figure 4.24: Possible hybrid formal vectors created through the addition or multiplication of two wave-shapes. The top right of the chart shows hybrids created through addition, while the bottom left shows hybrids created through multiplication. Greyed out graphs indicate that the morphology would not be a possible formal vector. Some quantization has been applied to get the charts to conform to the integer-based formal vector system. In each graph, the x-axis indicates section, whilst the y-axis indicates material type. All original graphs were scaled between 0 and 1.

4.7 Formal Types

Now that *shape*, *structure* and *state* and their interrelations have been defined, along with their grounding in vectors and waves, combinatorics, and statistics, we can rebuild Tenney's theory of form based upon these principles. Figure 4.26 shows a reworking of Tenney's ideas of form from Figure 4.4. I have kept the elements of *Shape*, *Structure* and *State*, but replaced their subcategories with descriptions that relate directly to the ideas outlined over this chapter. Each musical form is created through the interaction of shape, structure and state. Each difference in the relation between these three things creates a different form.

It is not possible, in the space of this chapter, to outline a comprehensive typology of form. However, hopefully what follows gives enough of a starting point for further research. Figure 4.26 shows a few simple, commonly-used forms and the way they have been derived from the theoretical framework outlined in this chapter. As I stated at the beginning of this chapter, the beauty of this theoretical framework is that it is predictive so, even though I use it here to primarily define formal types which already exist, this is only to prove its efficacy; it is more than possible to extend what follows to build a more extensive and completist typology. Many of the forms described will be familiar or existing forms - *Variation Form*, *Arch Form*, *Loop Form* and *Moment Form* are certainly not my inventions, but here they are placed within a much larger cosmology and coupled with *ceteris paribus* examples to more clearly illustrate their characteristics.

4.7.1 Linear Form

Linear Form has an Interpolative Binary Shape involving the interpolation between two parametric states. In other words, its structure is $\mathbf{A} \rightarrow \mathbf{B}$ with a morphological vector of [1]. It consists of four different subtypes: *Ramp Form*, *Funnel Form*, *Wedge Form*, and *Ergodic Form*. Each of these four forms is based around the relationship between the state of the two sections and the size of the spread of a particular parameter in each of them:

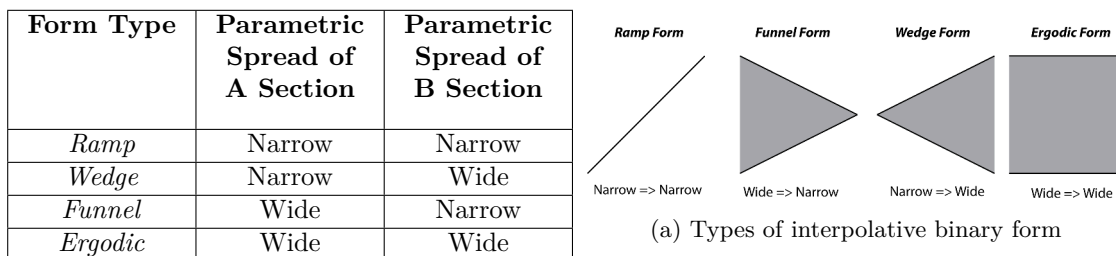

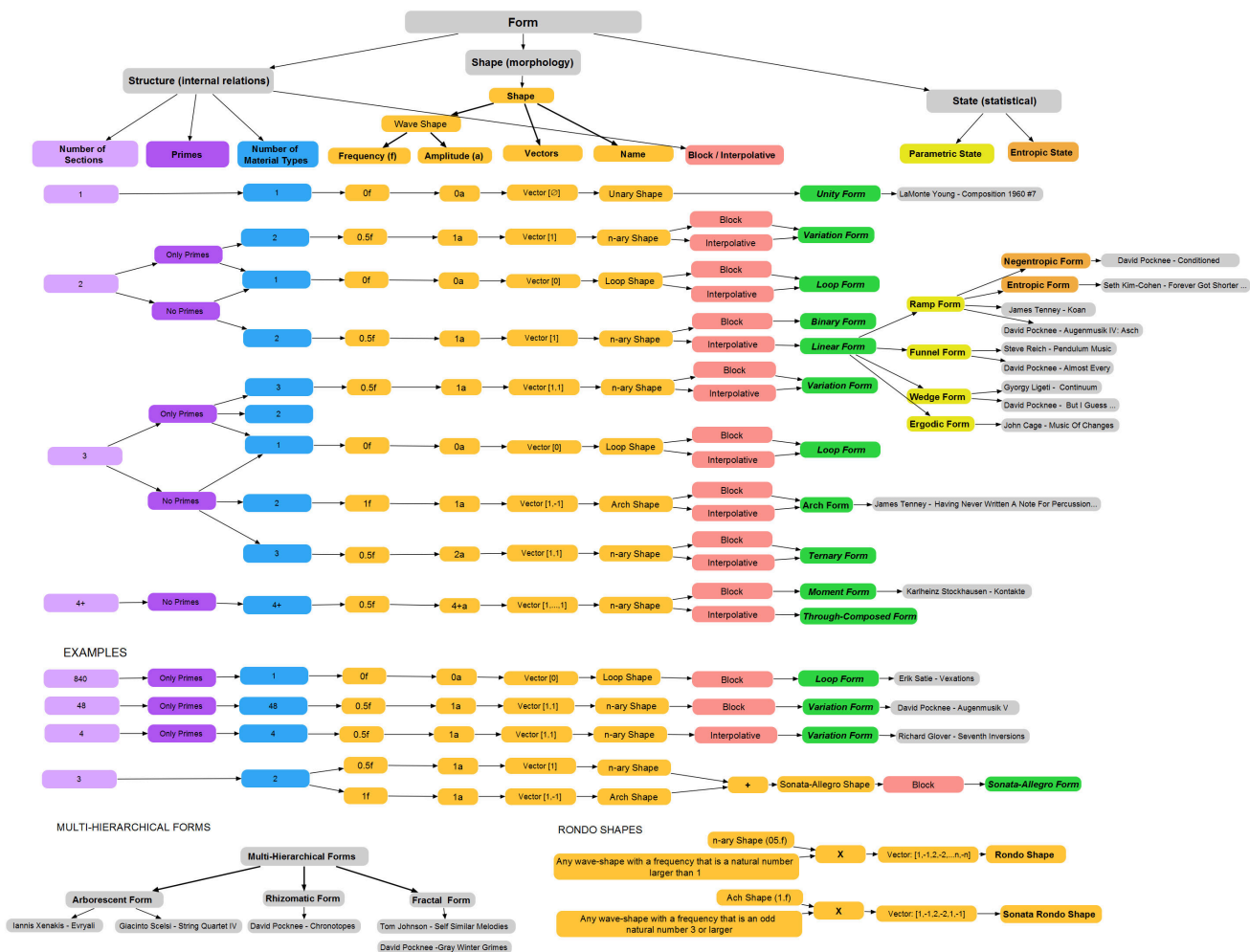

Figure 4.26: My new version of Tenney’s conception of form. This diagram is not exhaustive but highlights some of the key forms and some of the examples that can be found over the next few pages. The second column lists whether the form uses *Only Primes* (i.e. those structures which only feature prime-marked variations on a single section e.g. $AA'A''$) and *No Primes* (i.e. those structures which feature no sections marked with primes). This is because the archetypal types of form listed are more prevalent at these extremes and not in structures which mix the two categories. Also, the *state* categories are not exhaustive and simply there to highlight sub-categories of *linear form* which seem bountiful in Experimental Music.

Ramp Form

Ramp form was a term coined by James Tenney in his article *Form in Twentieth-Century Music*. It describes a piece that has "been 'moving' in a given direction, which has finally brought it to some intrinsic limit" (Tenney 2015, 157). We can think of this form as being in two sections: a place which has been moved from, and a place that is being moved to. These two places are then interpolated between. The second of these two sections consists of a state in which one parameter is at an extreme; an "intrinsic limit" in Tenney's words. Additionally, we can imagine the first of these sections consisting of a state in which that parameter is at the opposite extreme.

A good example of ramp form can be found in Tenney's piece *Koan* (Figure 4.27). This work, for solo violin, consists of double-stopped pitches slowly moving in a continuous glissando from the bottom of the violin to the top. The **A** section of this work has a state in which the pitch of the violin is at its extreme lowest, and the **B** section of the work has a state in which the pitch of the violin is at its extreme highest, with the work interpolating between these two extremes **A**→**B**.

It is important to note that, even though this form is a binary form, the interpolative nature of the movement between the two sections and the lack of sectional division can make it appear like a *Unary* structure.

(a) Score of James Tenney's *Koan* (Tenney 1984, 200)

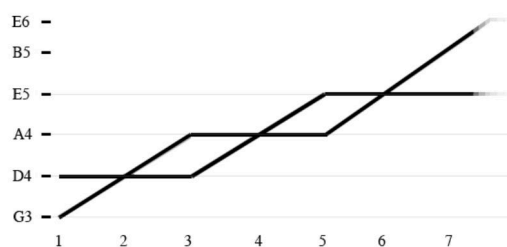

(b) Diagrammatic representation of pitch movement in James Tenney's *Koan* (Féron 2014, 106)

Figure 4.27: James Tenney's *Koan*

Ramp form can be seen in many of my works, where it primarily involves the movement from the lowest to highest pitch of a particular instrument, such as in *Augenmusik VI: Asch*, or in its inverse in *The Descent* (seen in Figure 4.28). This approach was applied to two instruments in *We Doubled Down The Base Camps* (2016) for violin and cello, in which the instruments move from their lowest pitches to their highest. The underlying ascending harmonic structure of this work is laid bare in *It's A Diagram If You Believe It, A Relic If Not* for four tunable sustaining instruments (Figure 4.29).

The clarity of a ramp form is defined by the logic of its beginning and ending points. In using instrumental limits as the beginning and ending points of a form, and moving from one to the other at a continuous speed, an expectation is set up: the piece will terminate once we have transitioned from one extreme to the other, or we have reached a point at which the performer can physically go no further (e.g. has reached the top of the piano keyboard, after which there are no more keys).

The Descent

for Leo

David Pocknee
30/07/2015

The musical score for "The Descent" for Leo is composed of 11 staves. The first staff is a single melodic line. The subsequent staves are arranged in pairs, with the left staff of each pair containing a complex, multi-voice texture of chords and the right staff containing a single melodic line. The music is written in a key with one sharp (F#) and a common time signature. The score concludes with a final double bar line on the 11th staff.

Figure 4.28: Score of *The Descent*.

It's A Diagram If You Can Believe It, A Relic If Not

for quartet of tunable instruments

David Pocknee

The score is composed of 12 staves, each representing a different instrument in the quartet. The notes are written in a single system with a common key signature of one sharp (F#) and a common time signature. The fret numbers for each note are as follows:

- Staff 1: -31, +6, -12, -6, -10, -6, +10, -21, +14
- Staff 2: -14, +4, -41, -39, -8, -10, +8, +12
- Staff 3: 0, -29, -10, -6, -8, -6, -23, +14, +10
- Staff 4: 0, +2, +4, -45, -8, -41, +8, -4, +10, -4
- Staff 5: +16, +18, +12, +10, -21, +16, -17, +14
- Staff 6: -21, -19, +16, +14, -21, +8, +12, +14, -19, +16
- Staff 7: +14, +16, -4, +12, -21, +10, +14
- Staff 8: +12, 0, -17, -2, +10, -23, +8, +12, +18, +16
- Staff 9: -35, -23, -27, +40, +22
- Staff 10: -17, +14, -21, +42, -29, -25, +38, -11, +20, +8
- Staff 11: -2, -17, +46, +44, -23, -27, +24, +36, +22, +6, +26
- Staff 12: 0, -19, -25, -29, -43, +5, +36, +6, +24

Figure 4.29: Score of *It's A Diagram If You Believe It, A Relic If Not*.

Types of Ramp Form: Entropic and Negentropic Forms

Although ostensibly any parameter or parameters can have ramp form applied to them, two subtypes are worthy of note: *entropic* and *negentropic* forms. In each of these, there is the movement between maximal and minimal entropy.

Entropic and *Negentropic* are similar to Tenney's definition of *Kitchen Sink* and *Classical* forms, which describe complex-to-simple and simple-to-complex formal trajectories.

Seth Kim Cohen's work for drumkit, *Forever Got Shorter*, is one example of an entropic form, in which the piece moves from minimal to maximal entropy. An extract of the score, presented in Figure 4.30, explains how this is achieved - the regularity of a drumbeat gradually dismantled through the re-adjusting of the slope of the stage.

The opposite of *entropic form* is *negentropic form* in which the piece moves from a high level of entropy to a low level of entropy. The best example of this that I could think of this is a work written just before my PhD, called *Conditioned* (2013), in which a performer is slowly conditioned, using a Pavlovian methodology, over the course of the piece, to play one of a set of sounding objects when shown a symbol on a screen, correct answers being rewarded with sweets. The work moves from a situation in which there is no relation between the symbols and the sounding result, to one in which the two are clearly causally linked.

Forever Got Shorter (from a t-shirt of the same name) For Solo Trap Kit Dedicated to Michael Lenzi

Seth Kim-Cohen

Text score for a piece first performed by Ross Parfitt in 2010 at Bank Street Arts, Sheffield, England.



A drummer on a small platform plays a slow, heavy trap kit beat. Each time the drummer presses down on the kick drum pedal, he or she is also pressing down on a car jack. The jack gradually lifts the drummer's end of the platform until the drums and cymbals begin to tumble away. The drummer's seat is secured, ensuring that he or she will not similarly tumble. The piece is finished when the drummer can no longer reach any drums or cymbals.

Figure 4.30: Extract from the score of Seth Kim-Cohen's *Forever Got Shorter (from a tshirt of the same name)* (Kim-Cohen 2010, 1)

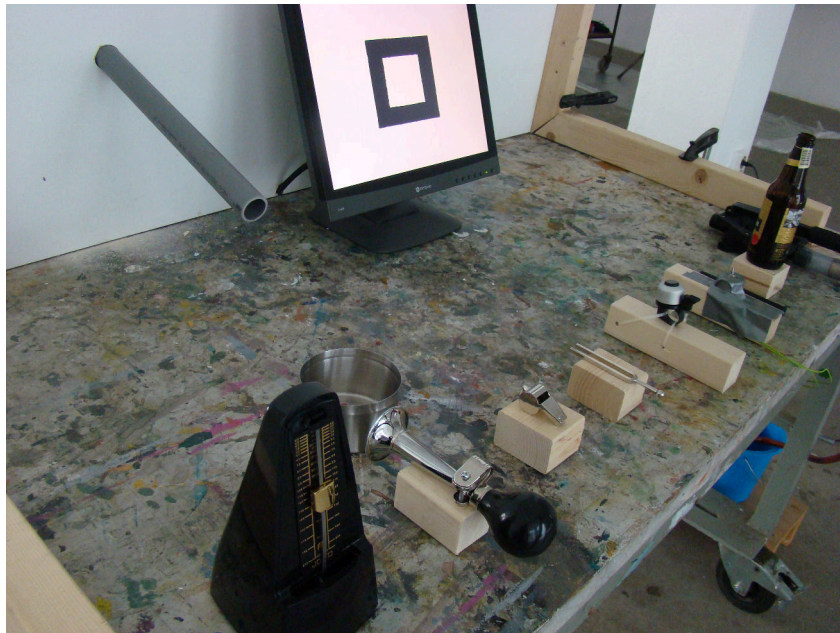

Figure 4.31: Set up for *Conditioned* for the "subject" being conditioned (photo by Ana Lemnaru).

Wedge Form



Figure 2: Piano-roll graph of *Continuum*. The x-axis represents time and the y-axis represents pitch.

Figure 4.32: Diagrammatic representation of pitch movement in György Ligeti's *Continuum* for solo harpsichord (from (McKean 2011, 3))

Wedge form involves the movement from a narrow parametric spread to a wide one. An example of this can be seen in Ligeti's *Continuum*, which starts in a small pitch area, confined to the centre of the harpsichord's range, but opens out to encompass the entire range of the keyboard (see Figure 4.32).

All of the pitch material in *But I Guess, In The End, We Just Moved Furniture Around* is based on small and large scale wedge-forms that operate on the parameter of pitch (see Figure 4.33).

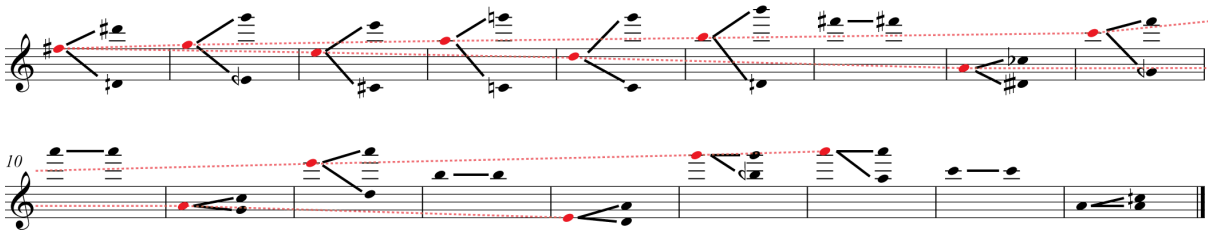

Figure 4.33: Diagram showing wedge form in *But I Guess, In The End, We Just Moved Furniture Around* for solo flute. Each bar is one of the 18 sections in which the flute plays. In each section, lines show how the ambitus of the flute melody increases over the course of the section. Additionally, the starting pitches for each section (in red) perform their own wedge movement over the course of the piece, shown with the dotted red lines.

Funnel Form

Funnel form is the opposite of wedge form, in that the parametric spread goes from being very wide to very narrow. An example of this can be found in Steve Reich's *Pendulum Music* (score in Figure 4.34a), where there is a literal funnelling of the breadth of swing of the microphones from large to small.

What is seen in Reich's piece is an example of *damped harmonic motion*, in which "the amplitude of any real oscillating spring or swinging pendulum decreases in time until the oscillations stop altogether", usually caused by the resistance of air and internal friction within the oscillating system (see Figure 4.34b, which shows a typical graph of the displacement as a function of time) (Giancoli 1980, 284).

Almost Every uses a mimicked version of damped harmonic motion to create a trajectory from a large amount of parametric movement to near-stasis. This is also a form that can be seen in the work *Funnel* in Figure 4.35.

Ergodic Form

Ergodic form is another phrase coined by Tenney to describe "a process in which the statistical properties of each part at the next lowest hierarchical level are the same as those of every other part at the same level." (Tenney 2015, 157). Although he distinguishes two types of ergodic form, here it will only be used to describe works in which "the statistical homogeneity is the result of the constant use of the entire range of each parameter-often by way of chance methods, though sometimes via serial methods also." (Tenney 2015, 157). John Cage's *Music of Changes* may be a good example of ergodic form, wherein there is a continual use of a very wide parametric spread.

PENDULUM MUSIC

FOR MICROPHONES, AMPLIFIERS, SPEAKERS AND PERFORMERS

2, 3, 4 or more microphones are suspended from the ceiling by their cables so that they all hang the same distance from the floor and are all free to swing with a pendular motion. Each microphone cable is plugged into an amplifier which is connected to a speaker. Each microphone hangs a few inches directly above or next to its speaker.

The performance begins with performers taking each mike, pulling it back like a swing, and then in unison releasing all of them together. Performers then carefully turn up each amplifier just to the point where feedback occurs when a mike swings directly over or next to its speaker. Thus, a series of feedback pulses are heard which will either be all in unison or not depending on the gradually changing phase relations of the different mike pendulums.

Performers then sit down to watch and listen to the process along with the audience.

The piece is ended sometime after all mikes have come to rest and are feeding back a continuous tone by performers pulling out the power cords of the amplifiers.

Steve Reich 8/68

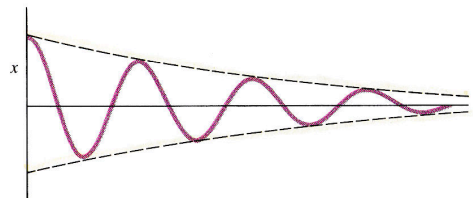

(b) Diagram showing damped harmonic motion (Giancoli 1980, 284).

(a) The score of Steve Reich's *Pendulum Music* from (Mertens 2004, 54)

Figure 4.34: *Pendulum Music* and damped harmonic motion.

4.7.2 Unity Form

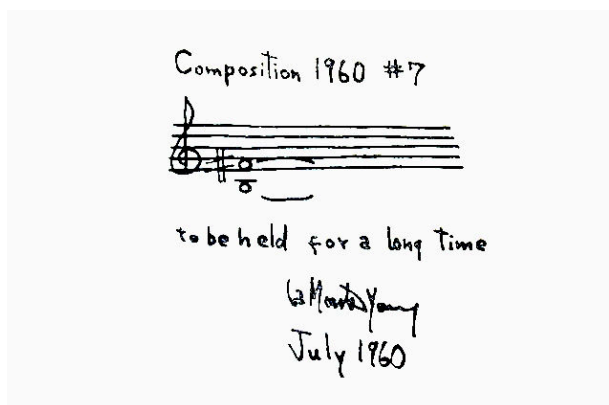

Figure 4.36: Score for LaMonte Young's *Composition 1960 #7* (from (Lely and Saunders 2008, 425))

Unity form consists of a single section in which parametric change is minimal. A good example of this is LaMonte Young's *Composition 1960 #7* (Figure 4.36) in which only one thing happens, without any notated change for "a long time".

4.7.3 Variation Form

My use of the term *Variation form* differs little from its historical usage to signify a work consisting of multiple sections, each involving musical material that is repeated, with a different developmental approach applied each time. This can be seen in some of the works I have previously discussed, especially those in the *Augenmusik* series. However, it might worth noting that, in my typology, variation need not be limited to the usual block forms. In Figure 4.37, Richard Glover's *Seventh Inversions* provides a good example of an *Interpolated Variation Form*, in which the variations on each of the seventh chords (i.e. their inversions) are interpolated between using glissandi.

4.7.4 Loop Form

Loop form simply involves the repetition, verbatim, of a section of music. A good example of this is Erik Satie's *Vexations*, which asks the player to repeat the same page of material 840 times (Figure 4.38).

Funnel

An ensemble of sonically diverse instruments
haphazardly spread around a stage or other space
all playing at the same volume: mezzo forte.

Start playing simultaneously.
Your first note should be
at the top or bottom pitch extreme of your instrument,
but not on the same pitch as anybody else
- this will have to be decided beforehand.

Always play three pitches every second
but not in rhythmic synchrony with any other player.
The pitches played by each player
should not be evenly spaced within each second
and each pitch should sound until their next pitch is played.

Repeating the same pitch directly after you have played it is forbidden.

All performers should stop playing when they are all playing the same pitch.

dp

2017-04-14
rev. 2017-08-13

Figure 4.35: The piece *Funnel* (2017).

4.7.5 Arch Form

HAVING NEVER WRITTEN A NOTE FOR PERCUSSION
for John Bergamo

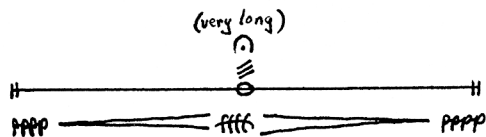

James Tenney
8/6/71

Figure 4.39: Score of James Tenney's *Having Never Written A Note For Percussion* (Tenney 1984, 203)

My use of the term *arch form*, like *variation form*, differs little from its historical usage. Probably the clearest *ceteris paribus* example of this form in action is in James Tenney's *Having Never Written A Note For Percussion*. An arch form always involves a return - in this way it is similar to *Voyage and Return* types of narrative, such as *The Odyssey*.

4.7.6 Moment Form

Moment form is a form pioneered by Karlheinz Stockhausen, discussed in his articles *Momentform* (1960) and *Erfindung und Entdeckung*, and utilised in works such as the electronic piece *Kontakte* (1959-60) and *Moment* (Kramer 1978, 179).

Moment form is a "succession of self-contained sections that do not relate to each other in any functionally implicative manner" (Kramer 1978, 179), what Dahlhaus refers to as *musique informelle* (Whittall 2001, 93) or what A. B. Marx refers to as *Gang* (Marx 1997, 67). Moment form consists of an n-ary structure of four or more sections: **ABCDE...n**.

In relationship to our discussion of the connections between musical and narrative forms, Stockhausen specifically defines moment forms as opposed to "dramatic" or "closed development" form. This is partly due to the inability for moment form to create large scale narrative:

Seventh Inversions

Richard Glover

The score consists of four staves: Violin I, Violin II, Viola, and Violoncello. Each staff has four measures corresponding to chords 1, 2, 3, and 4. Above each chord, there is a boxed number (1, 2, 3, 4) and a '3'' marking. Below each chord, there are numerical values indicating intervals or fingerings: for Violin I (+33, -16, +14, -31); for Violin II (+17, -2, -17, +2); for Viola (+31, -33, +16, -14); and for Violoncello (+31, -33, +16, -14). Dashed lines connect the interval markings between the Violin I and Violoncello staves.

- Timings are approximate
- Play with a balanced, moderate dynamic
- The notes in each of the four chords (indicated by boxed numbers) should be played on a single string
- All glissandi are in unison and should be double-stopped. During glissandi, each player should slowly slide one finger to a tone slightly flatter than the first, before sliding the other finger down to achieve a unison. Continue this process until the destination note is reached. This process should sound entirely fluid and should produce a continuously-sounding glissando
- Scordatura may be used to achieve greater control over the double-stopped glissandi

Figure 4.37: Score for Richard Glover's *Seventh Inversions* (Glover 2010)

NOTE DE L'AUTEUR:

Pour se jouer 640 fois de suite ce motif, il sera bon de se préparer au préalable, et dans le plus grand silence, par des immobilités sérieuses

Figure 4.38: Instructions from the score of Erik Satie's *Vexations*

Since moment forms verticalize time, render every Now, avoid functional implications between moments, climaxes, they are not beginning-middle-end forms. piece must start for simple practical reasons, it may must stop, but it may not end. ...

(Kramer 1978, 180)

4.7.7 Formal Types Involving Multi-Hierarchical Relations

All of the above types of form deal with only the organization of the *very topmost* hierarchical level of a musical work. However, as we have seen earlier, Tenney's idea of form is based on a recursively nested set of shape, structure and state whose properties at a given hierarchical level help define the shape, structure and state of that directly above.

Obviously, some forms are defined not only by their highest hierarchical level and, though the following is incomplete, I describe below some of the more common types of multi-hierarchical formal organization.

Arborescent and Rhizomatic Form

Arborescent forms are defined by very specific relations between their elements, which resemble the branching of trees. Examples of this can be found in Xenakis's explicitly arborescent work such as *Evryali* and *Erikthos* (see Figure 4.40) as well as, more metaphorically, in the branching focal pitches in Giacinto Scelsi's fourth string quartet (see Figure 4.41).

In contrast, one could define a *rhizomatic form* as consisting of a multi-hierarchical set of connections, but one in which the causal linkages between each element are less top-down. In contrast to the continual branching from a given "trunk", a rhizomatic form might be one in which this branching happens without

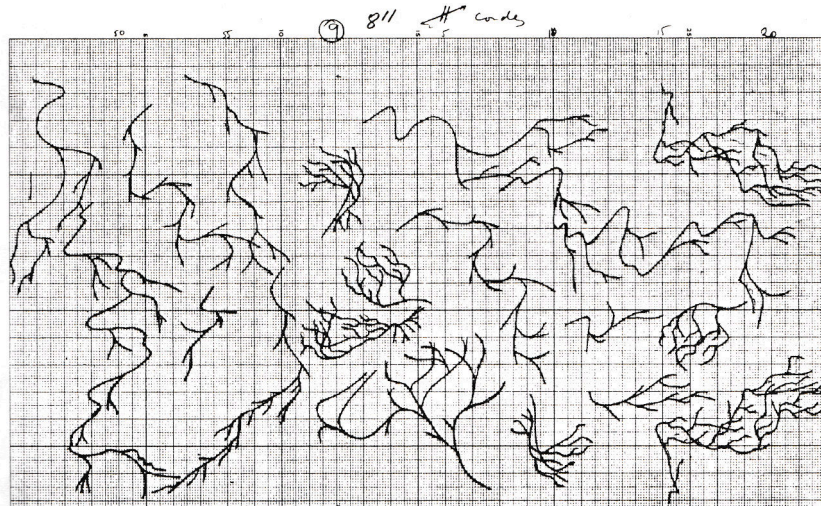

Erikthon, 1974. Arborescences and their transformation in a pitch-time space taken from a design before transcription into traditional music notation

Figure 4.40: Compositional sketches for Xenakis's arborescent piece *Erikthon* from (Matossian 1986, 237)

any trunk having been defined.

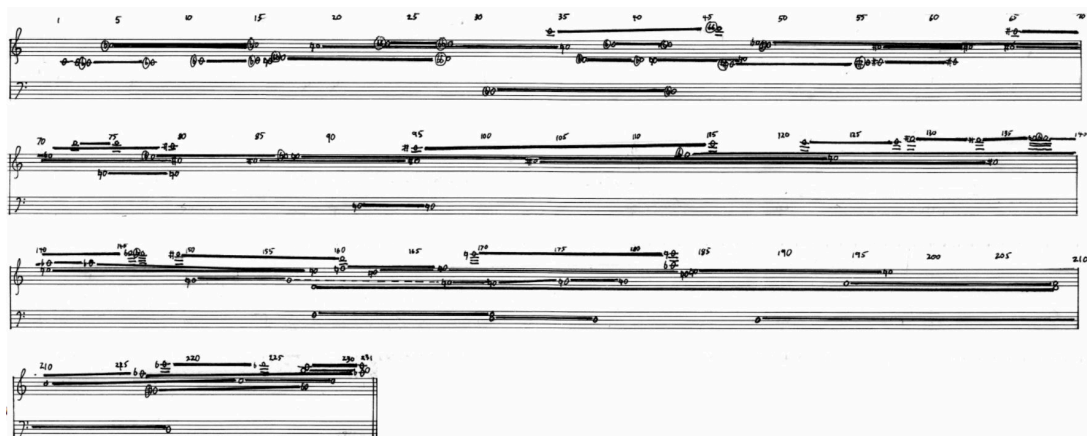

Figure 4.41: An analysis of focal pitches in Giacinto Scelsi's *Quartetto No 4* (Pocknee 2009)

For instance, my *Chronotopes* series asks performers to find their way, in a dot-to-dot manner, through a series of notes spread randomly over a sheet of paper (see Figures 4.43, 4.44, 4.45). A Rhizomatic form can also be seen in *Selfhelplessness*.

Fractal Form

Fractal forms are those in which the relationship between large and small hierarchical elements is identical. This can be seen in works such as Tom Johnson's *Self-Similar Melodies* and John Cage's early percussion works, such as *First Construction In Metal*, although, being pre-fractal, he refers to this as "micromacrocsmic ordering" (Guessford 2004).

A similar fractal structure can be found in my flute work *Gray Winter Grimes* in which the tablature pattern showing which fingers on the flute should be depressed is based on a *gray code*, a structure created by the mathematician Frank Gray that allows the exhaustion of all combinations of 1s and 0s



Figure 4.42: Example of a fractal melody from (Johnson 1996, 146): "The sequence is self-similar at the ratio of 4:1 and at 16:1, and you can read an inversion of it if you look at every second note or every eighth note, and it behaves like a single repeated procedure, even though it is a hybrid that alternates between two transformation rules."

in a binary bit-string of a given length in an order that ensures the change of only one bit between each combination. This translates to a set of flute fingerings in which only one finger at a time is moving. More importantly, the standard gray code is fractal.¹⁴

¹⁴More information on the musical application of Gray Codes can be seen in Michael Winter's paper *On Minimal Change Morphologies* (Winter 2014).

Chronotopes DD_MM_YYYY-HH:MM:SS
for any-sized ensemble of pitched, equal-tempered instruments
for Philip Pocknee

PHILIP: Are there any dot-to-dot music pieces...
DAVID: ...wait a minute...

About

Chronotopes is based on the solo piano piece *Chronotope*¹ and uses scales and relationships taken from the piano work *Labyrinth II*.

Any ensemble (2 - ∞ players) of pitched, equal tempered instruments can play this work.

In this work, a series of numbered chords or notes are arranged randomly and out-of-order on sheet(s) of paper – one per performer.

The performers try to find and play each chord or note in order, treating the score like a dot-to-dot puzzle.

All durations are based around the time it takes the performer to find the next chord.

For this reason, the score should not be seen by the performer before the moment of performance, to prevent memorization of the order.

For the same reason, any score can only be used once – each performance should use a new score, specifically generated by the composer for the occasion.

The scores are algorithmically generated and take approximately two minutes to produce.

No score can be used more than once.

If you would like to perform this work, please contact the composer for a unique score (my contact details can be found at www.davidpocknee.com).

Performance

All performers should start with their part placed on a music stand with the side of the paper containing the notes not visible.

On a cue, given by one of the players, all performers should simultaneously flip over their part so that they can see the notes.

Each performer immediately starts trying to find the note/chord numbered “1”.

Upon finding this note/chord they should play it and immediately start searching for the note/chord numbered “2”.

They must hold note/chord “1” until they find note/chord “2”.

Upon finding chord “2” they immediately stop playing note/chord “1” and play note/chord “2”.

They continue in this manner, sustaining the last note/chord they found until they find the chord numbered sequentially higher, until they can no longer find any more chords/notes.

If the performer is not physically capable of sustaining the note/chord for the length needed to find the next one, they should sustain it for as long as is physically possible/their instrument allows e.g. length of a breath/sonic decay.

If a player is performing on an instrument with infinite sustaining capabilities, they should stop playing as soon as they realize there are no more chords to find in the piece.

¹ I use the *Alien* method of assigning titles. If the series continues I look forward to writing *Chronotopes vs Predator*.

Figure 4.43: Instructions from *Chronotopes*

Dynamics

No dynamics are given in any parts.

There are several options of which dynamics to use in this piece, the piece can be played in several versions:

Wandelweiser Version – all notes/chords should be played as quiet as possible.

First Hague School Version – all notes/chords should be played as loud as possible.

Romantic Version – the dynamics of each note/chord should be played according to the inner-soul of the performer.

Cage Version - the i-ching is cast to decide on the dynamics for each note/chord.

Boulez Version – the dynamic series from *Structures* is used.

Mezzo Forte Version – all notes/chords should be played *mf*.

Pixies Version - quietquietquietLOUDLOUDLOUDquietquietquietLOUDLOUDquietquietquiet etc.

Players should either all use the same dynamic option, or each pick their own.

If there are large discrepancies in volume between the dynamic ranges of the instruments, all instruments should match their dynamic range to that of the quietest instrument

e.g. in an ensemble of marimba and guitar, the marimba should scale its loudest note to the guitar's loudest note.

Scores

All versions of *Chronotopes* DD_MM_YYYY-HH:MM:SS exist only as a set of parts, not a full score, for obvious reasons.

Example

Over the page is an example work for orchestra and piano.

This score is ONLY AN EXAMPLE and should NOT be used for performance.

Figure 4.44: Instructions from *Chronotopes*

Chronotopes 10_02_2014-21:56:25 (flute part)
for Philip Pocknee

David Pocknee

The image displays a musical score for a flute part, consisting of ten staves of music. The notation is in treble clef with a key signature of one flat (B-flat). The score includes various musical notations such as notes, rests, and dynamic markings. Above the notes, there are numbers 1 through 40, likely representing measure numbers. Some notes are marked with '8va-' and a flat symbol, indicating an octave lower. The score is arranged in a vertical sequence of staves, with the first staff starting at measure 30 and the final staff ending at measure 8. The notation is sparse, with many measures containing only a single note or a rest.

The New Fordist Organization 2014 (www.acesinstitute.eu)

Figure 4.45: The flute part from a version of *Chronotopes*

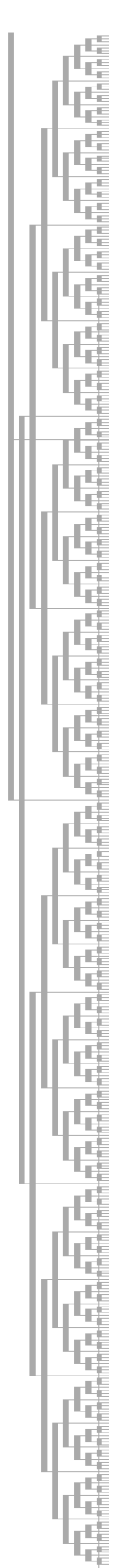

Gray Winter Grimes

for flute

after Frank Gray, Michael Winter and Alex Grimes

David Pocknee

Thumb
Index
Middle
Ring
Little

Left Hand

Index
Middle
Ring
Little

Right Hand

Index
Middle
Ring
Little

Right Hand

Figure 4.46: Page 1 of *Gray Winter Grimes* (the full gray code can be seen above the title).

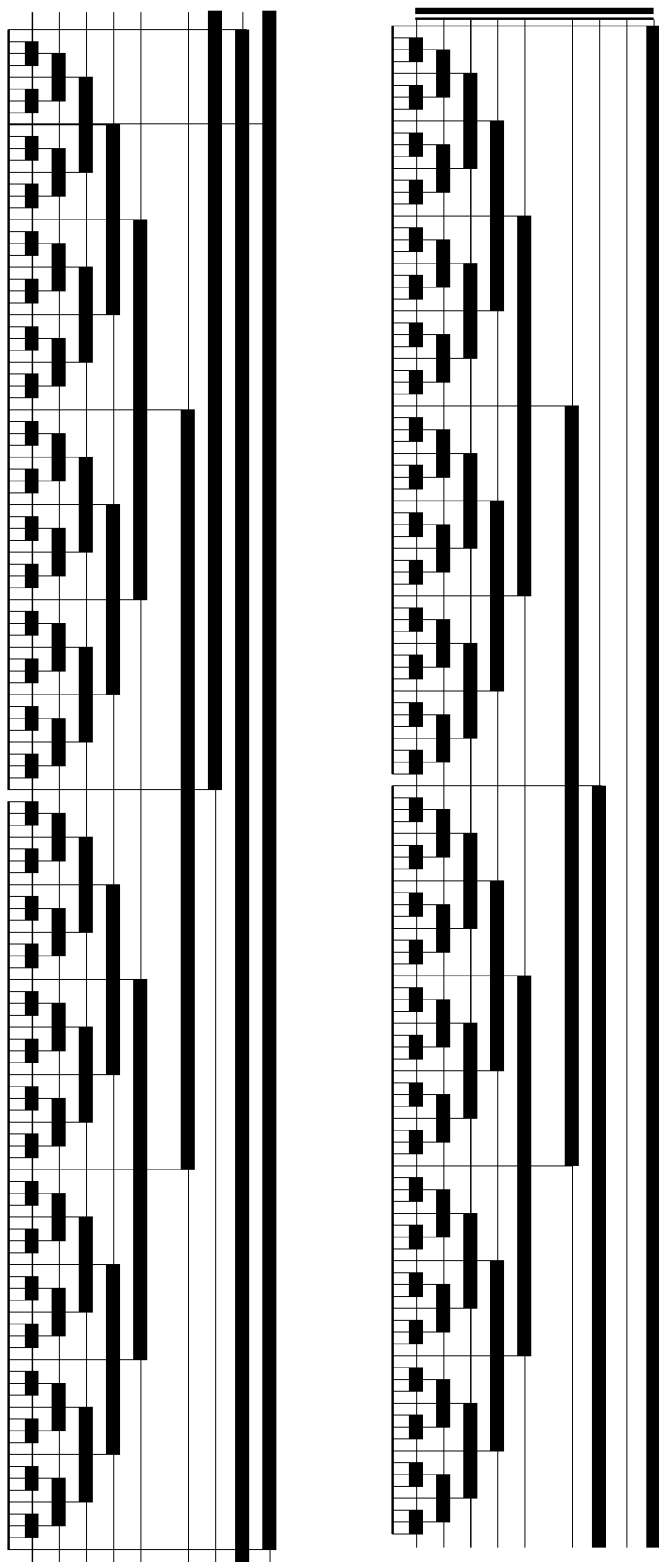

Main aim of the piece: **Either** complete as much of this piece as possible in one breath **Or** complete the entire piece in as few breaths as possible.
 Choose breathing, embouchure and finger speed to optimally achieve this aim.
 This piece only notates the movement of each of the nine fingers traditionally used to play the flute.
 Each finger should be in its conventional place on the flute, positioned over one of its traditionally assigned keys.
 Each thin horizontal line in the score is assigned to a specific finger.
 Where a black rectangle occurs on this line, the corresponding finger should fully depress a key.
 Where there is the option that multiple keys could be played with a specific finger, the key that helps best achieve the main aim should be chosen.
 Where the difference between the possible keys is negligible, the one which creates the greatest change in sound should be chosen.
 Vertical lines are used to show the order of events in time, but not necessarily their proportional relation to each other.
 The order of events must be strictly followed.
 When a key combination allows the possibility for a pitch to sound, this pitch must sound.

dp (2017-04-27)

Figure 4.47: Page 2 of *Gray Winter Grimes*

Chapter 5

Process

I will fasten a wolf skin about my back, and o'er my head put the brute's gaping jaws; then fitting its fore-feet to my hands and its hind-feet to my legs I will go on all-fours in imitation of its gait to puzzle the enemy when I approach their trenches and barriers around the ships. But whenever I come to a deserted spot, on two feet will I walk; such is the ruse I have decided on.

- Euripides *Rhesus* (Euripides 1952, 205)

And this is like the trailer before the main feature, or perhaps, more accurately, like watching the *Making Of* before the movie - spoiler alert! But, if you've read this far, you can probably guess what comes next: This chapter outlines the processes used to compose the Conclusion of this thesis. The Conclusion is where I show some of the possibilities of taking a compositional approach to thesis writing. It's not exhaustive, nor perfect, but hopefully imaginative and inspiring. I'm merely pointing towards the possibilities of what a thesis could be.

The last four chapters have been necessarily associative and logical, justifying the acausal, bisociative and process-driven nature of the Conclusion. Over these chapters, I have laid down a conceptual framework that allows process-led, bisociative, compositional thesis-writing to be justified in relation to the existing practice-as-research paradigm, meaning that if someone in the future should want to attempt the type of compositional thesis writing you will see in the Conclusion, they can skip all the justifications and cut straight to the chase, with this thesis sitting referenced, linked and loved in the backmatter of their bibliography. And maybe it seems a disappointment to see bisociation squeezed finally at the end of such an epic (read "long") piece of writing, but sometimes we must work in disguise to achieve our aims, to put on our wolfskin to infiltrate the enemy encampment.

Over the previous four chapters of this thesis I have explicated the principles behind my process of composition. No matter how disparate the material, this process asserts itself again and again:

1. *Quantize* reality to create discrete compositional elements (Chapter 1).

The first stage of any composition is the gridding of the undifferentiated, chaotic continuity of reality into discrete objects - the formulation of a particulate system upon which the discrete nature of a compositional system can operate upon - *compositional quanta*. This can occur through a straight-forward quantization process or via the imposition of conceptual grids, using *theoretical readymades*.

e.g. In *Almost Every* we imposed a grid which only included fingered pitches and natural harmonics (up to the 5th partial) on the guitar which sounded the pitch E.

2. Use a *completist* approach to list the combinatoric possibilities of the quantized elements (Chapter 3).

Permutation, combination, enumeration, mapping, re-ordering and direct transcription are all techniques for calculating the combinatoric potentials of the compositional quanta. A completist approach reduces redundancy, ensures the exhaustion of all possibilities, and delimits a compositional space.

e.g. In *Almost Every* every playable combination of the 17 Es was calculated.

3. If the number of possibilities is too large, reduce the options or use *divination* to select a subset of the possibilities (Chapter 2).

Completist procedures often generate numbers of possibilities that exceed practicality. This can be avoided by re-quantization or by using divinatory procedures to navigate the combinatoric space. e.g. It would be impossible to read every book in the University of Huddersfield Library, so divination was used to select the books and journals to read.

4. Order the possibilities selected in time; create a *form* (Chapter 4).

As Robin Maconie, discussing Stockhausen's work, notes: "Ending a permutational form is nearly always a matter of taste, not design. While the listener may be satisfied with a sensation of completion, the composer knows that though a series of permutations may eventually be exhausted, it does not automatically resolve. The ending's essential arbitrariness has to be disguised." (quoted in (Kramer 1978, 180-181)). The combinatorial space is ordered to create meaningful high-level shapes, structures and states.

The Conclusion to this thesis has a number of different processes applied to it, each of which follows the compositional approach above.

5.1 Design

I start a new
paragraph. I refer to a footnote¹
I go to a new sheet of paper.

1. I am very fond of footnotes at the bottom of the page, even if I don't have anything in particular to clarify there.

Figure 5.1: (Perec 1999, 11)

Again[in B.S. Johnson's House Mother Normal], typography and the physical form of the book function to reinforce its theme. Each line of each chapter corresponds in time to the same line in each of the other chapters, an attempt at simultaneity which has occasionally humorous ramifications: the final chapter has several blank pages - the character has dozed off.

(Ryf 1977, 64)

In Chapter 1, I identified page layout and font as the two design elements I would be composing. In literature and poetry, this approach has many predecessors, especially in Concrete Poetry (see (Williams 2013)), and in the work of writers such as Raymond Federman, particularly in his book *Double or Nothing* (see Figure 5.2).

In music, this approach could be traced back to the typographic experiments of *Ars Subtilior* and also seen in later works such as John Cage's *62 Mesostics re Merce Cunningham* (see Figure 5.7b) and the more subtle serialized typesetting of Stockhausen's *Aus Den Sieben Tagen* (see Figure 5.3 and (Bandur 2001, 45)).

not NOODLES though
 that stuff that en
 riched stuff keeps
 for years could us
 e something else t
 hough just in case
 POTATOES for insta
 nce NO you have to
 tell it straight e
 xactly how it happ
 ened there is enou
 gh to tell without
 inventing 39 cents
 a BOX that's too m
 uch 25 that's clo
 ser check of cours
 e but can one surv
 ive on NOODLES cou
 ld take a quick su
 rvival course just
 in case perhaps eg
 g NOODLES might be
 safer richer in ca
 lories egg NOODLES
 for a more complet
 e diet tastier too
 just a few pennies
 more for a BOX let
 us say 29 cents fo
 r a BOX sounds rig
 ht could vary a ma
 n's got to vary sh
 ells one day macar
 oni the next spagh
 etti elbows spears
 manicotti flat one
 s round curly then
 back to shells all
 kinds all the same
 price 29 cents for
 a BOX 365 times 29
 careful now 365 mu
 ltiplied by 29 ma
 kes \$105.85 just t
 hink \$105.85 for N
 OODLES alone defin
 itely POTATOES wou
 ld be cheaper of c
 ourse but would th
 ey keep NO eventua
 lly they get those
 long grey rat tail
 s and after a whil
 e they're like spo
 nges gives you the
 creeps NOODLES you
 said NOODLES it is

Figure 5.2: Extract from Raymond Federman's *Double or Nothing* (from (Wielgosz 1995))

<u>Text order-number</u>	<u>Title</u>	<u>Scoring</u>	<u>Process-type</u>	<u>Typography</u>	<u>Date</u>
1	RICHTIGE DAUERN	c. 4 players	Pointillist	Centered	May 7
2	UNBEGRENZT	ensemble	Pointillist	Centered	May 8
3	VERBINDUNG	ensemble	Scale	Left margin	
4	TREFFPUNKT	ensemble	Refrain	Centered	
5	NACHTMUSIK	ensemble	Mediation	Centered	
6	ABWÄRTS	ensemble	Scale	Left margin	
7	AUFWÄRTS	ensemble	Mediation	Centered	
8	OBEN UND UNTEN	theater piece	Mediation	Centered and Left margin	
9	INTENSITÄT	ensemble	Pointillist	Centered	
10	SETZ DIE SEGEL ZUR SONNE	ensemble	Mediation	Centered	
11	KOMMUNION	ensemble, at first 3, then 4, 5, 6, 7	Scale	Left margin	May 10
12	LITANEI	"to the player" [speaker or choir]	Non-Process	Left margin	
13	ES	ensemble	Pointillist	Centered	May 11
14	GOLDSTAUB	small ensemble	Pointillist	Centered	
15	ANKUNFT	any number of musicians [speaker or speaking-choir]	Non-Process	Left margin	

Karlheinz Stockhausen, Aus den sieben tagen (1968): Abwärts and Richtige Dauern (Kohl, 1981, p. 241) has shown that serial thinking even in this text-based composition is a relevant feature.

Figure 5.3: Typography in Stockhausen's *Aus Den Sieben Tagen*, from (Bandur 2001, 45)



Figure 5.5: A T-shirt, entitled *Thesis 5x5*, designed using the same algorithm used for page layout in this thesis.

5.1.1 Page-Layout

This thesis is presented on a rectangular sheet of A4 paper in the "portrait" orientation. The space of this paper is a 2D combinatorial space ripe for exhaustion. On the pages of this thesis, all text and images occur within a smaller rectangle surrounded by blank margins. We can refer to this smaller rectangle as the *writing-rectangle* (see Figure 5.4).

The page is a continuous space, but if we apply the type of quantization process outlined in the first chapter, this can be transformed into a composable space. First, a grid must be imposed. Within this grid, the size and position of the writing-rectangle can be defined by the two coordinates of its top-left and bottom-right corners.

We can define a grid by its number of horizontal (h) and vertical (v) divisions. The number of possible unique writing-rectangles can then be calculated using the following equation:

$$\sum_{k=1}^h n \times \sum_{k=1}^v n$$

For instance, we could enumerate the number of possible unique writing rectangles in a 5x5 grid as follows:

$$\sum_{k=1}^5 n \times \sum_{k=1}^5 n = 15 \times 15 = 225$$

This 5x5 grid was used to create a t-shirt, inspired by the page-layout used in the conclusion of this thesis (Figure 5.5).

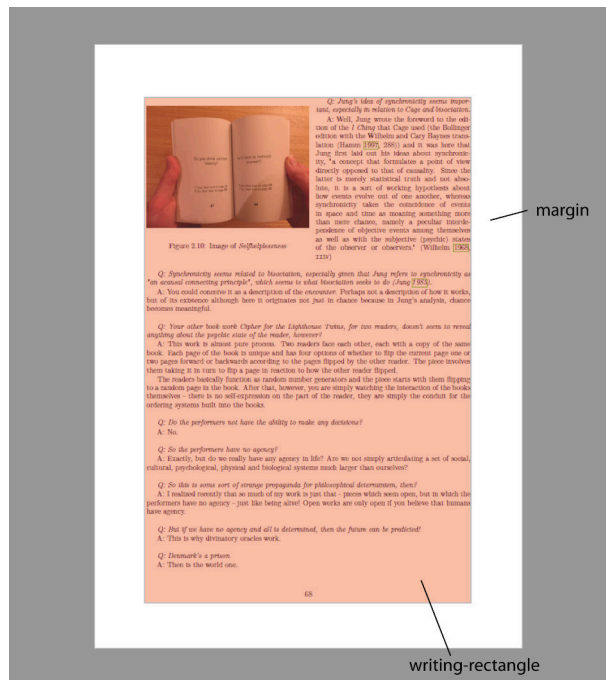

Figure 5.4: Components of the page-layout.

Q: What's the deal with these grids?

A: Oh. You're back.

Q: I had to take a phone call.

A: For 113 pages?

Q: I was trying to sort out a - it doesn't matter. What are you trying to do?

A: I want the Conclusion of this thesis to use all possible page-layouts in a particular grid.

Q: Ah, a completist thing, OK, but why not just randomly pick any grid and use that - like how you did in your divination chapter?

A: Because I want the writing-rectangles on all of the page-layouts to be filled, and if I'm using every possible writing-rectangle in a given grid, the amount of writing that can be fitted into all of these page-layouts changes wildly depending on the grid used.

Q: Oh, so you're afraid that if you choose the wrong grid, you'll have too much or too little writing to fill all of the possible page-layouts?

A: Exactly.

Q: So did you write the Conclusion beforehand and are trying to find a set of possibilities that it can fit in?

A: Yes, I wrote it first - it took up approximately 13 pages with a normal page-layout (the one used on this page) and using that information I calculated the approximate surface area the text would need. In a normal page-layout, there is a margin of 1 inch (2.54 cm) around the writing-rectangle, so its surface area can be calculated by subtracting the 1 inch (2.54 cm) margins from the length and width of the page:

$$(21 - 2.54 - 2.54) \times (29.7 - 2.54 - 2.54) = 391.95\text{cm}^2$$

Multiplying this by 13 gives the total surface area needed for the Conclusion: $391.95 \times 13 = 5095.36\text{cm}^2$.

Q: Sorry, nodded off there - so, cut to the chase; what was the best size of grid to use?

A: Applying a grid of 3x3, with a sigmoid variable of 2.5 ...

Q: A what?

A: I weighted the grids using a *sigmoid* function, so that the grid-lines get closer together as they approach the edge of the page.

Q: Why would you do that?

A: I think it lessens the abruptness of transition between the normal page-layout and these new ones.

Q: Sure, whatever. So how many page-layouts do you get with a 3x3 grid?

A: 36 (seen in Figure 5.6). The grid occurs at the following points: $x = 2.54\text{cm}, 6.80\text{cm}, 14.20\text{cm}, 18.46\text{cm}; y = 2.54\text{cm}, 9.13\text{cm}, 20.57\text{cm}, 27.16\text{cm}$. The total surface area of the writing-rectangles is 4801.4cm^2 .

Form in my Works

Q: You've talked about form a lot - how did you end up ordering these 36 page-layouts? I've noticed you're pretty much a one-trick pony when it comes to form.

A: What do you mean.

Q: Well, it's either Linear Form or Variation Form, isn't it? Just look at Table 5.1, where I've categorized the contents of your portfolio according to the form used.

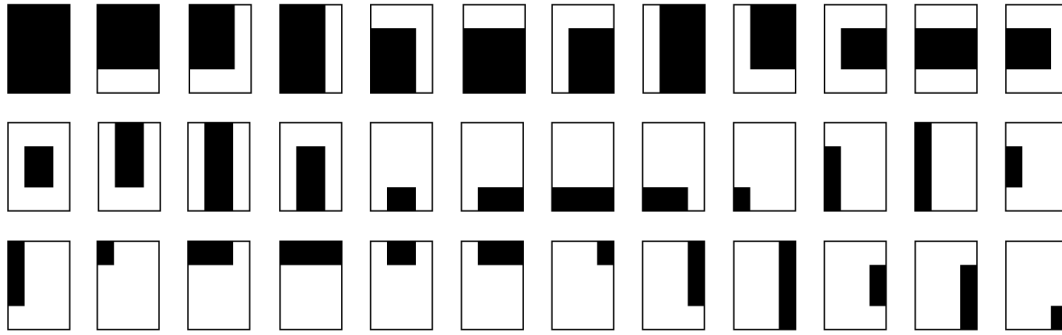

Figure 5.6: The 36 possible page-layouts when the page is divided into 3 sections placed into an order such that there is minimal change between the size and position of each page-layout.

A: Yes, but it's more complicated than that, it's a dialectic-

Q: *I bet you've just used these two forms for all of the typographical, syntactic and semantic processes in the conclusion, haven't you?*

A: Yes, but there's layering and interac-

Q: *Thought so. So which of these forms did you use for the page-layouts?*

A: Ramp Form.

Q: *Classic $A \rightarrow B$ narrative. What were the starting and ending points, though?*

A: Well, it works like this ...

Formal Type	Diagram	Description	Works
Linear Form	$A \rightarrow B$	One thing slowly changing into another.	<ul style="list-style-type: none"> • Almost Every • We Doubled Down The Base Camps • The Chord Catalogue (Redux) • But I Guess, In The End, We Just Moved Furniture Around
Variation Form	$AA'A'' \dots$	One thing repeated, slightly different each time.	<ul style="list-style-type: none"> • Augenmusik IV: Paperwork • Augenmuik V: Blooper Reel • MG3250 Performs Cornelis Cardew's "Treatise"
Linear/Variation Combination	-	-	<ul style="list-style-type: none"> • Augenmusik VI: Asch
Rhizomatic	-	-	<ul style="list-style-type: none"> • Selfhelplessness • Cipher for the Lighthouse Twins
Other	-	-	<ul style="list-style-type: none"> • Digging Piece • A Beethoven Mesostic

Table 5.1: Types of forms used in works in my PhD portfolio.

1. Let us first conceive of an $A \rightarrow B$ narrative:
2. Given that this process will begin directly after the termination of the chapter you are reading, which uses a conventional page-layout, we can choose A to be the type of page-layout used here,

and in the rest of the thesis, allowing a seamless transition from the static nature of page layouts in the previous chapters to this new process.

3. **B** must now be chosen.
4. Given my appreciation of terminal narratives, it makes sense to me that **B** is a page layout which is at the extreme of the possibilities of page layouts.
5. One extreme, given the relatively large starting size of the page layout for **A**, is to make **B** the smallest possible page layout.
6. Given the sigmoid-derived distribution of the grid used, the smallest page layouts will be found in the four corners.
7. Given the direction of writing in English (left-to-right, top-to-bottom), it might be interesting to then choose the bottom-right corner as **B**
8. I now order the possible page layouts according to the following rules, designed to minimize change between each page layout:
 - (a) Each page layout is defined by four values: the top-left corner of the writing-rectangle (x_1, y_1) and the bottom-right corner of the writing-rectangle (x_2, y_2) .
 - (b) Each consecutive writing-rectangle can only change by one value.
 - (c) The value changed can only be by -1 or +1.
9. This leads to the order found in Figure 5.6). These page-layouts have been arranged such that there is minimal change in size and position between each layout, that they start with the "normal" page-layout used for the rest of this thesis, and that terminates with the smallest page-layout in the bottom-left of the page.¹

5.1.2 Font

Q: Are we going to see some cool font stuff in the Conclusion?

A: Yes, I ended up designing 11 fonts especially for it.

Q: That's pretty complicated, isn't it? Shouldn't you leave it to the experts?

A: Well, there's some software you can use to easily make fonts that is built into L^AT_EX.

Q: That's the typesetting software this thesis is coded in, right?

A: Yep. Anyway, it's called *METAFONT*.

Q: How does it work?

A: Well, it's basically a way of coding fonts that allows for multi-parametric font composition. You can see an example in Figure 5.7a, taken from a paper by Donald Knuth, who designed it. The figure shows one font slowly changing into another. You can see an example of the METAFONT syntax Figure 5.8.

Q: John Cage did some composed typesetting stuff, didn't he?

A: Yes, I guess the *62 Mesostics re Merce Cunningham* (Figure 5.7b) has some of that but it's, understandably, a more random approach to what I'm interested in doing.

Q: Which is?

A: A subtle linear interpolation between a seriffed and sans seriffed version of the same font.

Q: So ramp form again?

¹This order doesn't *exactly* fulfil all the criteria above, but is as close as possible.

The LORD is my shepherd;
 I shall not want.
 He maketh me to lie down
 in green pastures:
 he leadeth me
 beside the still waters.
 He restoreth my soul:
 he leadeth me
 in the paths of righteousness
 for his name's sake.
 Yea, though I walk through the valley
 of the shadow of death,
 I will fear no evil:
 for thou art with me;
 thy rod and thy staff
 they comfort me.
 Thou preparest a table before me
 in the presence of mine enemies:
 thou anointest my head with oil,
 my cup runneth over.
 Surely goodness and mercy
 shall follow me
 all the days of my life:
 and I will dwell
 in the house of the LORD
 for ever.



(a) Example of the possibilities of the gradual parametric changes possible in metafont, from (Knuth 1982, 15)

(b) Extract from John Cage's *62 Mesostics re Merce Cunningham* (<https://genericpronoun.com/2013/07/30/blind-in-a-good-way/>)

Figure 5.7: Typeface design by Knuth and Cage.

A: Yes - I took the *roman* and *sans serif* versions of the *Computer Modern* font designed by Donald Knuth using METAFONT.

Q: *Is that the font you're writing in now?*

A: Well, this is a slightly modified version called *Latin Modern*, but they're really similar. I linearly interpolated the values between the two fonts and then created 11 new fonts by taking the values at 11 equally-spaced points between the starting and ending values.

Q: *Why 11?*

A: There are 13 sections in the Conclusion, so I use one font for each section, including the original two fonts. You can see all the fonts in Figure 5.9. I rendered them using the program *FontForge* and coupled them with the page-layouts in *Adobe Illustrator*.

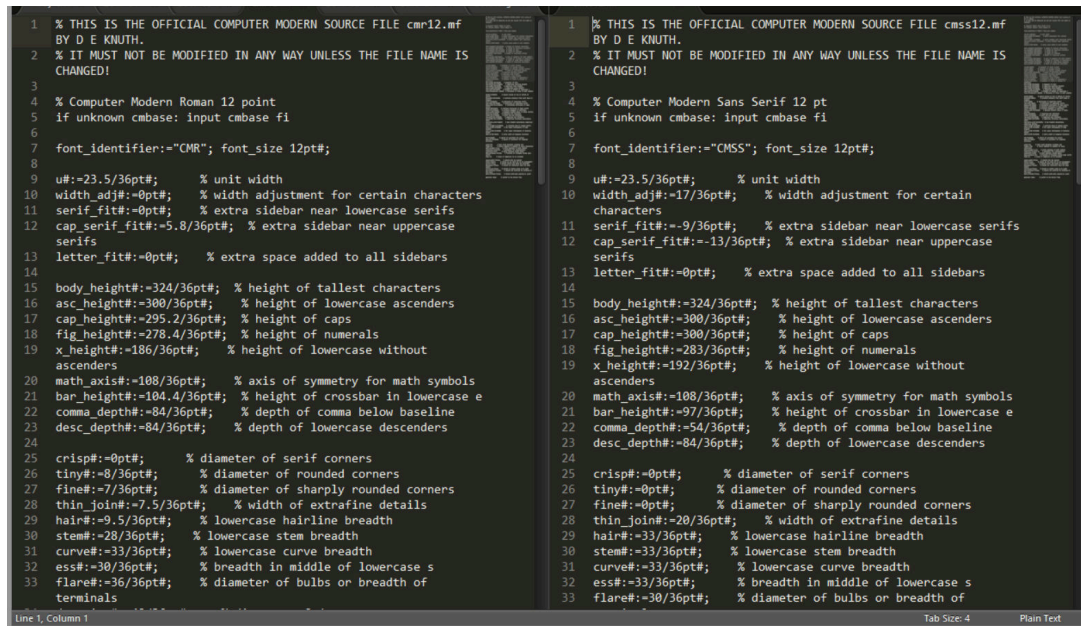

Figure 5.8: Start of the two metafont files open in the program Sublime Text. The file on the left is the *roman* version of *Computer Modern*, the file on the right is the *sans serif* version.

ABCDEFGHIJKLMNOPQRSTUVWXYZabcdefghijklmnopqrstuvwxyz1234567890 ,,:?!" &*() [] - " + = -
 ABCDEFGHIJKLMNOPQRSTUVWXYZabcdefghijklmnopqrstuvwxyz1234567890 ,,:?!" &*() [] - " + = -
 ABCDEFGHIJKLMNOPQRSTUVWXYZabcdefghijklmnopqrstuvwxyz1234567890 ,,:?!" &*() [] - " + = -
 ABCDEFGHIJKLMNOPQRSTUVWXYZabcdefghijklmnopqrstuvwxyz1234567890 ,,:?!" &*() [] - " + = -
 ABCDEFGHIJKLMNOPQRSTUVWXYZabcdefghijklmnopqrstuvwxyz1234567890 ,,:?!" &*() [] - " + = -
 ABCDEFGHIJKLMNOPQRSTUVWXYZabcdefghijklmnopqrstuvwxyz1234567890 ,,:?!" &*() [] - " + = -
 ABCDEFGHIJKLMNOPQRSTUVWXYZabcdefghijklmnopqrstuvwxyz1234567890 ,,:?!" &*() [] - " + = -
 ABCDEFGHIJKLMNOPQRSTUVWXYZabcdefghijklmnopqrstuvwxyz1234567890 ,,:?!" &*() [] - " + = -
 ABCDEFGHIJKLMNOPQRSTUVWXYZabcdefghijklmnopqrstuvwxyz1234567890 ,,:?!" &*() [] - " + = -
 ABCDEFGHIJKLMNOPQRSTUVWXYZabcdefghijklmnopqrstuvwxyz1234567890 ,,:?!" &*() [] - " + = -
 ABCDEFGHIJKLMNOPQRSTUVWXYZabcdefghijklmnopqrstuvwxyz1234567890 ,,:?!" &*() [] - " + = -
 ABCDEFGHIJKLMNOPQRSTUVWXYZabcdefghijklmnopqrstuvwxyz1234567890 ,,:?!" &*() [] - " + = -
 ABCDEFGHIJKLMNOPQRSTUVWXYZabcdefghijklmnopqrstuvwxyz1234567890 ,,:?!" &*() [] - " + = -
 ABCDEFGHIJKLMNOPQRSTUVWXYZabcdefghijklmnopqrstuvwxyz1234567890 ,,:?!" &*() [] - " + = -
 ABCDEFGHIJKLMNOPQRSTUVWXYZabcdefghijklmnopqrstuvwxyz1234567890 ,,:?!" &*() [] - " + = -
 ABCDEFGHIJKLMNOPQRSTUVWXYZabcdefghijklmnopqrstuvwxyz1234567890 ,,:?!" &*() [] - " + = -
 ABCDEFGHIJKLMNOPQRSTUVWXYZabcdefghijklmnopqrstuvwxyz1234567890 ,,:?!" &*() [] - " + = -
 ABCDEFGHIJKLMNOPQRSTUVWXYZabcdefghijklmnopqrstuvwxyz1234567890 ,,:?!" &*() [] - " + = -

Figure 5.9: The 13 fonts used in the Conclusion. The top and bottom fonts are the *roman* and *sans serif* versions of the *Computer Modern font*.

5.2 Semantics

5.2.1 Quantized Divination: Using Random Numbers to Select Books in Huddersfield University Library

I have managed to locate only one eye-witness description of the process that John Cage used to select library books for his class at UC Davis, discussed in Chapter 2. This account is in an article by John Dinwiddie, published in Issue 7 of *Source* magazine:

By consulting the *I Ching*, specific information could be derived in the following manner:

1. Out of the total number, one card drawer in the library is derived.
2. Out of the total in the drawer, one card is derived to indicate a specific unit of information (e.g., a book, a folio, a magazine, a score, a research report, a thesis, a microfilm, etc).
3. Out of such a selection, progressively smaller units of information are gleaned (e.g., a page, a paragraph, line, sentence, chapter, photo, diagram, even a single word or letter).

Instead of throwing coins or sticks to determine *I Ching* chance operations, Cage utilized the computer-programmed version by Ed Kobrin to derive the necessary hexagrams for the procedure described above.

(Dinwiddie 2011, 235)

Q: So Cage's residency at UC Davis was after he had started using a computer to consult the I Ching, rather than doing all the laborious coin-tossing by hand?

A: Yes, the computer program was written by Ed Kobrin in FORTRAN for Cage and Lejaren Hiller's *HPSCHD* work (the first performance of this work was earlier the same year as this class, on 18 May 1969 at the University of Illinois (Heimbecker 2008, 475)). It simulated the mechanism of the *I Ching* and even printed out the shape of the hexagrams (Revill 1992, 226). In later years, there was an implementation in *C* by Andrew Culver which was often used in works such as the number pieces (Weisser 2003).²

Q: How did you choose the books in the university library that you used to write the Conclusion?

A: In October 2013, at the start of my PhD, I asked University of Huddersfield Library to send me a list of every book they had on their shelves. I received a list of 148,402 books as an electronic .csv file.³ This allowed me to easily use random numbers to select books from this corpus.

Q: So you didn't have to deal with the more cumbersome draw-based library cataloguing system of the 1960s?

A: No, I just got a computer to generate some random numbers between 1 and 148,402 and then I had my books to read.

Q: Did you use Kobrin or Culver's programs to generate an I Ching-based random number?

A: No, as I mentioned before, Cage basically used the *I Ching* as a glorified random number generator anyway, so I didn't see the point in sticking to those.

Q: Also, don't those programs use pseudorandom number generators, rather than real randomness?

A: Yes, but according to Culver, Cage wasn't bothered by those sorts of distinctions; "John couldn't have cared less, didn't want to know about it really." (Tenney et al. 2010, 202).

Q: Do you?

A: Not really.

Q: But pseudorandomness is different from randomness.

²Culver's version is available for free from his website, both as a dos program (<http://www.newmus.net/filelib.htm>) and as a web-based application (<http://www.anarchicharmony.org/IChing/ic.cfm>) (Culver, n.d.)

³As an interesting side-note, according to my correspondence with the library, this was quite a task, as no-one had ever asked for this before, and it involved the compiling of several separate databases. As a result of this, the library learned that they had significantly less books than they had thought, leading them to correct this fact in their promotional literature. I would like this noted as part of my "original contribution to knowledge".

A: Well, a lot of online cryptographic security is premised upon the idea that pseudorandom number generators can produce numbers indistinguishable from random ones. Do you use online banking?

Q: *Yes, but -*

A: So it would seem hypocritical to put the safety of your life savings in the hands of online banking but shirk at the use of pseudorandomness in composition. If there's any difference, it's between pseudorandom number generators and *cryptographically secure* pseudorandom number generators, like *Fortuna*. Anyway, I bypassed these types of problems by using random.org, which utilizes atmospheric data as its main entropy source.

Q: *OK, so what exactly did you do?*

A: On 5 April 2017 at 15:06 I generated 9 random numbers between 1 and 148,402 using random.org which I then used to select books from the corpus of library books. I read all of these books and then used this information to trigger bisociative inspiration that fed into the Conclusion. This list of books can be found in the *Quantized Divination Bibliography*, after the Conclusion.

Q: *You read all nine of them?*

A: Yup.

Q: *You maniac.*

5.2.2 Unquantized Divination: Dowsing for Journals in Huddersfield University Library

Dowsing is a form of unquantized divination, sometimes also referred to as "divining" or "water-witching" (Dillinger 2012):

Dowsing could be defined as the systematic search for hidden objects with a help of instruments that are—according to the standards of science—unsuitable for that task. The divining rod or dowsing rod (German: *Wünschelrute*; Italian: *bacchetta da rabadomante*; Spanish: *varilla de zahorí*; French: *baguette divinatoire/baguette de sourcier*) is the most important instrument of dowzers. A dowser (or diviner) might claim to be able to find a hidden spring with a simple Y-shaped stick cut from some tree. The diviner would hold the two short ends of the rod in both hands and move about with it. When the long end of the rod began to tremble or bend down—supposedly on its own accord—it indicated where hidden items could be found. Earlier, dowzers claimed to be able to find water, minerals or buried treasures that way.

(Dillinger 2012, 2)

Some students of dowsing believe that it is a way of externalizing aspects of the subconscious which we would otherwise not have access to.

Once we have acknowledged the importance of the subconscious, dowsing becomes so much more than a means of locating either water or minerals, valuable as these abilities may be. If the dowsed reflex accurately mirrors the unconscious mind, then we have access, albeit through a limited means of communication, to the unconscious mind.

- *Dowsing for Beginners* (Ozaniec 1994, xi)

A more rational explanation of the phenomena is that it is an example of ideomotor suggestion, the same principle used to explain the functioning of Ouija boards, in which, "if you focus on the idea of making a movement, you will end up making a similar tiny movement without realizing it" (Brown 2006, 45). These small movements are then amplified through the light and loosely-grasped dowsing rod.

Q: *Wait - what? Did you go dowsing?*

A: Yes.

Q: *Where?*



Figure 5.10: The author dowsing for knowledge in the University of Huddersfield Library (photo by Linda Jankowska).

A: In the University of Huddersfield Library.

Q: *You went dowsing for books?*

A: Well, seeing as I already had a divinatory way of navigating the library's *books*, I decided to use dowsing to locate knowledge from within their extensive collection of *journals* (see Fig 5.10).

Q: *But if you're looking for journal articles, couldn't you just search online, using the University's access to online journals?*

A: Many of the journals in the library are pretty old and aren't accessible digitally because the university subscribed to the online versions of journals only from the date at which they stopped ordering physical copies.

Q: *What did you find?*

A: Check the *Unquantized Divinatory Bibliography for Chapter 4 and Conclusion* after the Conclusion.

5.2.3 Unquantized Divination: Dérive for Journals in Huddersfield University Library

Much like Malcolm Gladwell's purposeless ambling around Bobst Library, I wandered along the aisles of journals in the University of Huddersfield Library, randomly pulling out journals to see if there was anything inspiring inside.

Q: *This is that psychogeographic idea you were talking about in Chapter 2, right?*

A: Yes. I was a bit stricter with how I used this technique, though - I looked at one issue of every single journal held in the library.

Q: *Every one? Even stuff like Abstracts of Chemistry, which you have no way of understanding?*

A: OK, I looked at one issue of every *non-hard science* journal in the library.

Q: *How did you do that?*

A: Started at the top floor of the library, went shelf-by-shelf until I'd looked at all of those journals, then worked my way down floor-by-floor. It took me three full days.

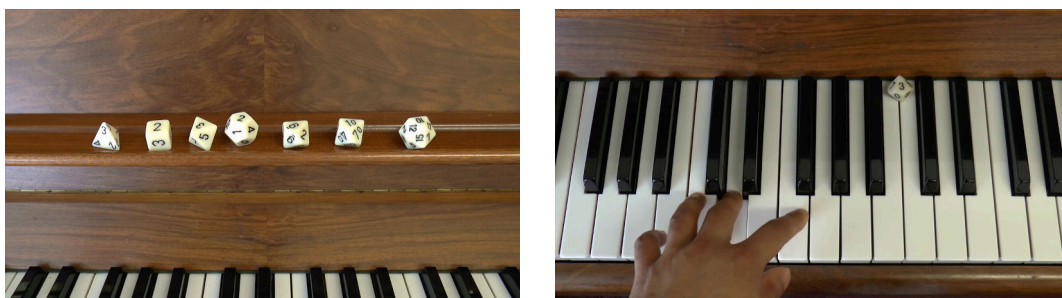

Figure 5.11: Video stills from a recording of *Some Short Pieces for Robert Blatt* (2016) <https://vimeo.com/167038294>

Q: Why didn't you do something a little looser, like with the dowsing?

A: I wanted to cover as much of the journal collection as possible and this was a way I could miss less and mop up stuff that wasn't covered during dowsing.

Q: When you're looking at a shelf of issues of a particular journal, how do you choose which one to look at?

A: Often the volume chosen was just intuitive, picking from between a set of identical looking spines which revealed almost nothing of their content. Other times I used multi-sided dice to select the cardboard container and issue, using a similar method to that behind my piece *Some Short Pieces for Robert Blatt* (2016), in which different-sided dice are used to select which note on the keyboard will be played (see Figure 5.11).

Q: Did you read all the articles in every volume you selected?

A: No, I'd do a quick skim read of everything in there then photocopy any article that was interesting to read at home.

Q: What did you find?

A: Check the *Unquantized Divinatory Bibliography for Chapter 4 and Conclusion* after the Conclusion.

Q: Did you read all of the articles in that bibliography?

A: Yes.

5.2.4 Information Found

Q: But if I look at the Conclusion of this thesis, how can I tell that any of the information you went out of your way to select through divinatory procedures and then read had any impact upon the finished result?

A: What do you mean?

Q: I mean that if part of your argument is about the importance of bisociative thinking in constructing new knowledge and making an "original contribution", how do I know that the ideas in the conclusion don't come from associative sources?

A: I suggest looking at Figure 5.12, in which I documented the origins of a large amount of ideas in the Conclusion and Chapter 4, and whether they came from bisociatively or associatively selected material.

Q: So, there's bisociative thinking in Chapter 4 as well?

A: Originally, there was no Conclusion to this thesis and, instead, all of the semantic, syntactic and design processes were going to be implemented in the fourth chapter on form. However, the problems that led to the unexpected lengthening of Chapter 4 (outlined in its introduction) forced me to abandon that idea, keep the more mathematical form-oriented stuff in it and move the more abstract ideas to the

Associative References			Bisociative References		
Author	No. of references	Percentage	Author	No. of references	Percentage
Male	43	75.44	Male	32	60.38
Female	6	10.53	Female	18	33.96
Mixed/Unknown	8	14.04	Mixed/Unknown	3	5.66
TOTAL	57		TOTAL	53	

Table 5.2: Table showing the gender of authors in Figure 5.12.

Conclusion.

Q: But why keep Chapter 4 so conventional?

A: Chapter 4 is a large collection of a lot of simple ideas put together in a novel way. The difficulty in writing that chapter is in conveying the simple ideas in a way that is straight-forward enough that their interactions are understandable. I couldn't do that if I applied the type of syntactic processes seen in the Conclusion.

Q: So does Figure 5.12 show all of the ideas used in Chapter 4 and the Conclusion?

A: Not all of them. For clarity, I only documented the start of the process. I finished Chapter 4 and the Conclusion (prior to syntactic restructuring) on 6 July 2017. The process of bisociative knowledging started with the selection of the nine library books on 5 April 2017. The chart tracks the process of generating and sourcing ideas from 5 April - 14 May 2017. Not all the ideas in the chart were used, and there are ideas which occurred later which do not appear in it. Yet, hopefully this is a useful way of helping to track the genesis of ideas and their elaboration.

Q: So, it's what? - yellow and purple nodes are books or journals found via bisociative knowledging and all other colours were associatively found?

A: Yes, and the outlines around each node indicate whether they are from female authors (red), male authors (blue), or mixed/unknown authors (grey).

Q: Why bother? Sounds like more bullshit liberal identity politics.

A: Well, I think it helps prove the point I made in Chapter 2, that "if the corpus of books contains an equal amount of men and women, it is statistically likely that the reference list of your thesis will be gender-balanced."

Q: I can't imagine randomly choosing which resources you read rather than associatively picking them would make any real difference.

A: In Table 5.2 I analyze the gender make-up of Figure 5.12 - it actually appears the number of female authors is pretty dire with the associatively chosen references, but increases by 23% if you bisociatively choose what you read.

Q: A 60%/34% split is still pretty unequal, though.

A: True, but it is better.

5.2.5 The Sortes and Random Quotations from Greek Dramaturgy and Shakespeare

Q: You know, I've also seen you referencing some of the things found in the Divinatory Bibliographies outside of Chapter 4 and the Conclusion.

A: That's true, occasionally I'd come across something by bisociative means that needed to appear in the associative sections of the thesis, so there's a sprinkling of bisociative thinking all the way through.

Q: So it's sort of similar to how you spread those quotations from Shakespeare and Ancient Greek dramatists at the start of sections and chapters throughout the thesis?

A: Yes, they were nearly all chosen using a *sortes*-style procedure of flipping to random pages in large collected volumes of works by these writers and seeing if there is anything on the open page which was relevant to the subject being written about.

Figure 5.12: (*following page*) Chart showing the way in which ideas for Chapter 4 and the Conclusion were generated. Nodes with a blue outline indicate they were written by male writers, those with a red outline were written by female writers, and those with a grey outline were written by a mixed group of writers, or a writer whose gender was not able to be determined.

5.3 Syntax

Syntax, traditionally, is the unity, the continuity of words, the law which dominates them. It reduces their multiplicity, controls their violence. It fixes them into a place, a space, prescribes an order to them. It prevents them from wandering. Even if it is hidden, it reigns always on the horizon of words which buckle under its mute exigency.

- Raymond Federman *Plagiarism* (quoted in (Wielgosz 1995, 100-101))

Cast your mind back to the chapter headings from *Linguistics for Dummies*, presented as a theoretical readymade in Chapter 1. In the Conclusion, as well as composing the design and semantics, I have composed the syntax of the writing.

5.3.1 Clauses

Syntax refers to how words group together to make phrases and sentences (Eppler and Ozón 2013, 248).⁴ An important intermediary between word and sentence is the clause, which can be defined as follows:

A term used in some grammars to refer to a grammatical unit intermediate between PHRASE and SENTENCE. The distinctive feature of clauses is that they have a **subject-predicate** structure. A predicate is typically a claim or assertion made about a thing or person. Its formation requires a **predicator**, or verb, with which to make the claim:

subject	predicate
<i>The boy</i>	<i>kicked the ball over the fence</i>
<i>The tall masted schooner</i>	<i>sank</i>
<i>She</i>	<i>slept</i>

- (Finch 2000, 88)

Another characteristic of clauses is that they can function as a sentence on their own, even when outside of the sentence structure of which they are a part. The subject-predicate structure of a clause can be broken down into four elements:⁵

- Subject (S) - the main actor in the clause. Usually a noun or person.
- Verb(s) (V) - the verbs used in the clause. Finite verbs can be used to control tense.
- Complement (C) - an optional component, used with transitive verbs. There are three types of complements:
 - Complement direct object (Cdo) - appear in clauses which involve a subject and an object. (*He ate the apple*).
 - Complement indirect object (Cio) - involve three participants (*He gave the apple to her*)
 - Intensive complement (Cint) - provide an attribute or quality of the participant (*He is hungry*).
- Adjunct (A) - an optional component, used for giving extra information about the clause, such as time, place, manner, reason, cause, effect, agency etc. (referred to in some texts as an *adverbial*).

Parse/Syntax Trees

⁴It is important to note that there are many different types of linguistic schools and subsequently many different types of linguistic analysis. The analytical terminology and techniques used within this thesis is not only specific to the English language but also reflects the theoretical orientation of the linguists I drew upon, specifically the writers of *Introducing Language In Use* (Merrison et al. 2005). In other words, the terminology and definitions I use in this thesis do not hold across all linguistic schools or even all linguistics textbooks.

⁵In some texts a clause can also be broken down into three elements: Subject, Verb, Object - SVO form; or five elements: Subject, Predicator/Verb, Object, Complement, Adjunct - SPOCA/SVOCA form. (Finch 2000, 115-118) The framework I am using, however, treats the object(s) of the sentence as a part of the complement structure.

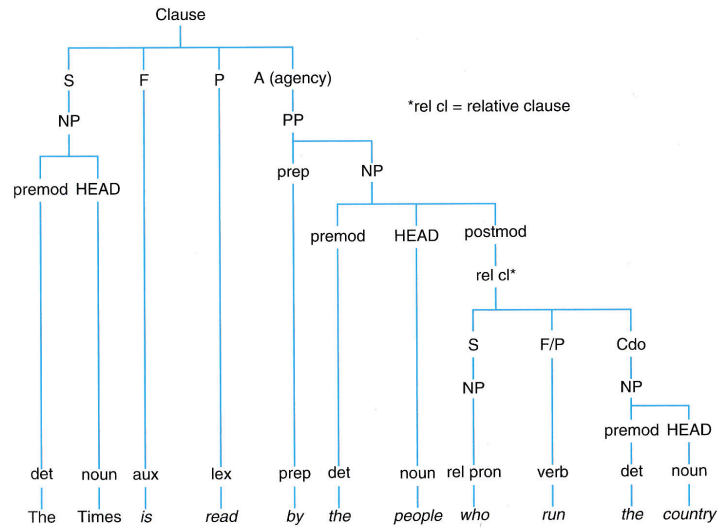

Figure 7.7 Relative clause in noun phrase (NP)

Figure 5.13: A parse tree from *Introducing Language In Use* (Merrison et al. 2005, 161) in which the clause structure of dialogue from an episode of the television show *Yes Minister* is analyzed.

The image in Figure 5.13 is of a parse tree, an analytical tool for understanding the structure of clauses. If you are a musician, there are two things you may notice. Firstly, it shares visual similarities with triplets in musical notation. Secondly, it shares another characteristics of musical triplets, in that it is recursive. In conventional western musical rhythmic notation, a triplet can be placed inside another triplet, such as a triplet being placed inside another triplet (see Figure 5.14). This recursivity is also present in sentence structures in English, where clauses can be nested inside other clauses. This can be seen in the example, with a relative clause being nested inside a noun phrase (NP), which is in turn part of a clause itself.

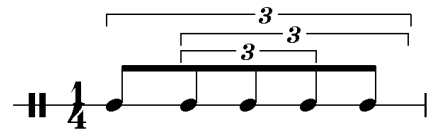

Figure 5.14: A recursive nesting of triplets.

In order to understand Figure 5.13, it is necessary to define some basic linguistic components used in these diagrams.

The English language can be conceived of as consisting of five basic components that are ordered in different ways to create meaning: Noun Phrases, Adjective Phrases, Adverb Phrases, Proposition Phrases and Verb Groups. These components can fit into different slots in the SVCA structure. Each of these components has a different structure:

- **Noun Phrase (NP)** consists of:
 - Premodifier (optional): Determiner (*det* e.g. the, a, an) / Adjective Phrase (*AdjP*) / Adverb Phrase (*AdvP*) / Noun Phrase (*NP*)
 - HEAD (obligatory) - noun (e.g. apple)
 - Postmodifier (optional) - Preposition Phrase (*PP*) / Noun Phrase
- **Preposition Phrase (PP)** Consists of:
 - Preposition (*prep* e.g. of, in, on)
 - Noun Phrase
- **Adjective Phrase (AdjP)** consists of:
 - Premodifier (optional): Adjective Phrase / Adverb Phrase
 - HEAD: adjective (*adj* e.g. cold, green, ripe)

* "... adjectives in English absolutely have to be in this order: opinion-size-age-shape-colour-origin-material-purpose Noun. So you can have a lovely little old rectangular green French silver whittling knife. But if you mess with that word order in the slightest you'll sound like a maniac. It's an odd thing that every English speaker uses that list, but almost none of us could write it out. And as size comes before colour, green great dragons can't exist." (Forsyth 2013)

- **Adverb Phrase (AdvP)** consists of:
 - Premodifier (optional): adverb (*adv* e.g. best, most, up, particularly)
 - HEAD: adverb
- **Verb Group (VG)** consists of:
 - Finite (optional)
 - Predicator

Using some completist-style thinking, we can enumerate all possible structures of these components (excluding Verb Groups, which will be discussed later) without recursion (see Figures 5.15). Given the possible valid arrangements of SVCA structure, I estimate this would give 36,720 possible clause structures, a figure which exponentially increases as levels of recursion are added.

Having defined the combinatorial space, this is clearly too large to exhaustively enumerate over the course of the conclusion. Given the similarities of parse trees to tuplets, perhaps some of the compositional processes behind writing tuplets can be applied directly to language?

Ferneyhough-ing Language

Parse trees have been used to analyze musical examples, as in Figure 5.16. However, as far as I know, musical processes have not been used to compose parse trees.

Brian Ferneyhough is a composer who makes extensive use of nested tuplets in his works. Figure 5.17 is taken from his article *Duration and Rhythm As Compositional Resources* (Ferneyhough 1995, 51-65). In it, a simple layering of three numerical processes of differing length change the rhythmic density of each bar, creating an implied accelerando towards the middle of the example. Ferneyhough conceptualizes bars as "not primarily a unit of emphasis, of agogic priorities, but a space, serving to delimit the field of operations or presence of specific sound qualities, of musical processes" (Ferneyhough 1995, 52).

In other words, the measure can be conceived of as a container of energy. Perhaps, we could similarly conceptualize the clause as a container of energy, defined by its density and complexity and which, through the imposition of processes, we could compose to achieve particular compositional effects.

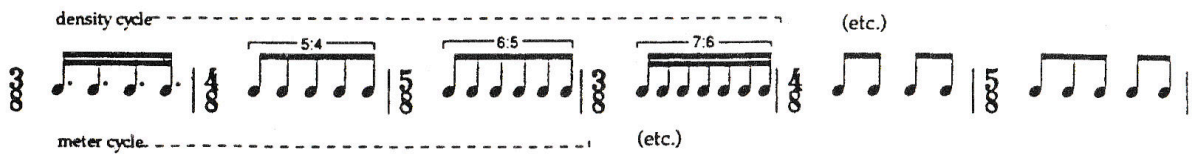

Figure 5.17: Example of one of Ferneyhough's characteristic processes used to compose tuplets (Ferneyhough 1995, 55).

Number of pulses in bar	3	4	5	3	4	5
Bar length	4	5	6	7	4	5

Table 5.3: Process used in Figure 5.17.

Mikhail Malt's description of Ferneyhough's rhythmic approach also highlights underlying ideas about why there might appear to be similarities between parse trees and his compositional approach, stating that Ferneyhough's compositional procedures "are applied to rhythms represented as trees (a representation discarded by a majority of composers but which fits surprisingly well Brian Ferneyhough's

Noun Phrases (21 Possibilities)

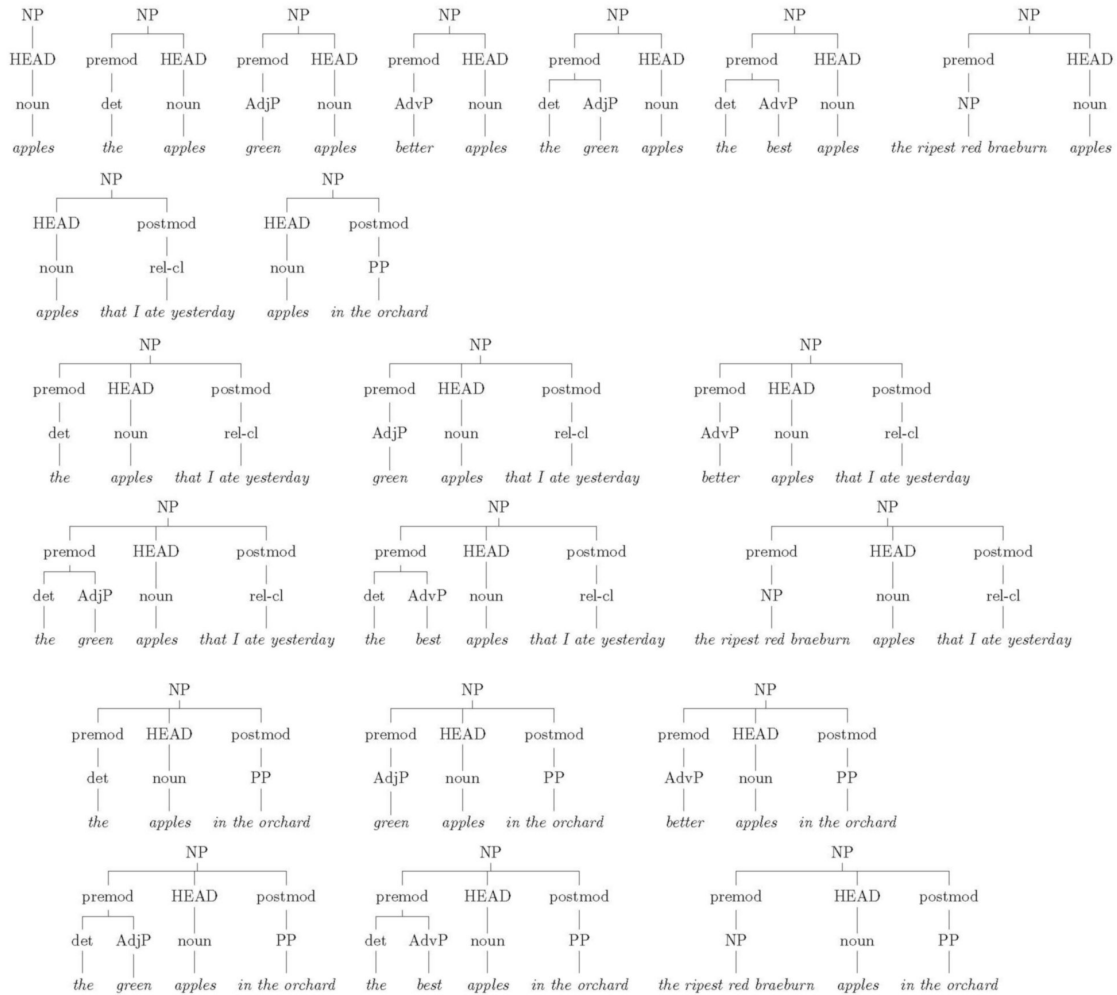

Adjective Phrases (3)

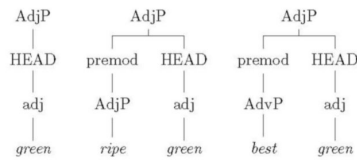

Adverb Phrases (2)

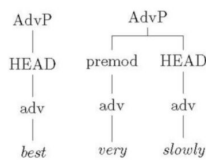

Preposition Phrases (1)

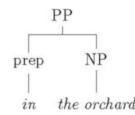

Figure 5.15: Table exhausting all possibilities of different phrase structures at 0 levels of recursion.

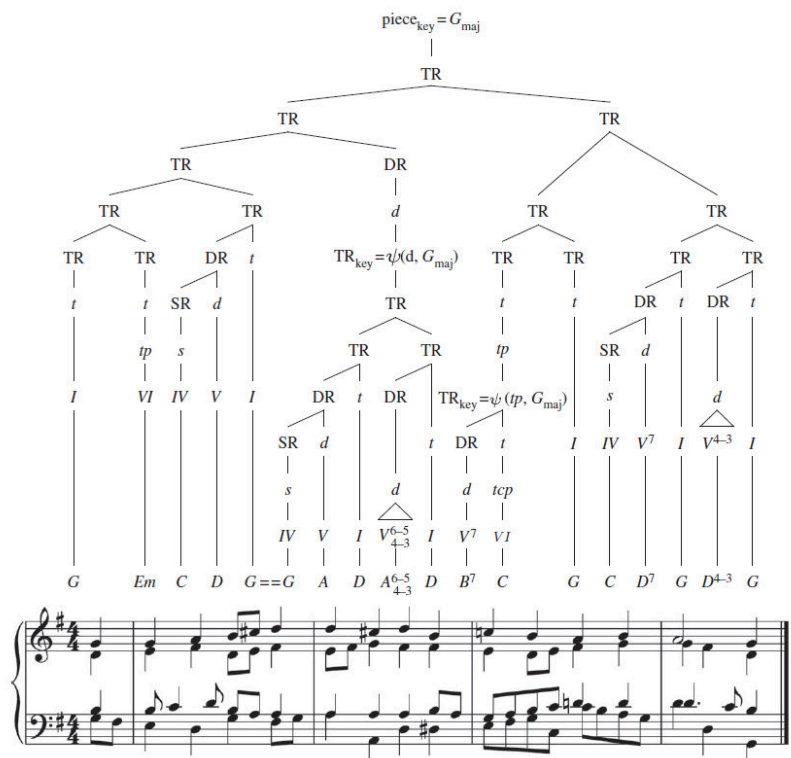

Figure 2. Analysis of Bachs chorale ‘Ermuntre Dich, mein schwacher Geist’ according to the GSM proposed by Rohrmeier [36]. The analysis illustrates hierarchical organization of tonal harmony in terms of piece (piece), phrases (P), functional regions (TR, DR, SR), scale-degree (roman numerals) and surface representations (chord symbols). The analysis further exhibits an instance of recursive centre-embedding in the context of modulation in tonal harmony. The transitions involving $TR_{key=\psi(x,ykey)}$ denote a change of key such that a new tonic region (TR) is instantiated from an overarching tonal context of the tonal function x in the key $ykey$.

Figure 5.16: Music/parse-tree analysis from (Rohrmeier et al. 2015, 5)

imagination)" going as far as to code rhythms using a symbolic representation known as *Rhythmic Trees* (Malt 2008, 8).

The Footnote

Checkhov told an aspiring writer "If in the first chapter you say that a gun hung on the wall, in the second, or third chapter it must without fail be discharged".
(Abbott 2008, 60)

Remember that enormous footnote on the first page of Chapter 1?

Q: How could I forget? What was it even there for? It was just rambling sub-Beat Generation nonsense; it was like slapping the reader in their face as soon as they got through the door.

A: There's something I really like about it, actually; an energy, a style, a poetry - I would have written the entire thesis like that if I could.

Q: You like it. Great. But why include it?

A: And it's not nonsense - it's about the limits of analyzing your own work and it serves a very specific function as a style model for the Conclusion.

Q: What do you mean?

A: I mean that the entirety of the Conclusion is built around the syntactic structure of that footnote. I used parse trees to deconstruct the footnote so I could replicate its energy. If you read the opening of the Conclusion it has the *exact same* syntactic structure as the footnote.

Q: Wait - so the footnote was a set-up to a punchline that only gets paid off 220-something pages later?

A: Exactly. As I said in the Introduction: "the aim of every facet of this document is to illuminate parts of my working process and approach to art-making in a way that would be difficult to achieve with words alone."

Q: But that whole first chapter is littered with unnecessary footnotes, literary flourishes and bizarre digressions - the whole chapter isn't a style model.

A: No, but it's trying to prove a point. Do you ever wonder why, in my compositions, I go out of my way to force my creative energy through such restrictive constraints?

Q: What do you mean?

A: I mean why have a guitar piece which is all Es? Why give myself the burden of having to surmount these self-imposed restrictions?

Q: Don't know. Masochism? Self-sabotage?

A: No. Chapter 1 is the answer. Chapter 1 is what happens when I write completely associatively and without constraints. And it's a mess. With its overlong footnotes and digressions and literary pretensions. I *need* constraints. I need those restrictions so that my work can make sense. To prevent me disappearing into self-indulgence and predictability.

Q: So Chapter 1 and the Conclusion are mirrors of each other, then? One extremely associative and free, the other extremely bisociative and constrained.

A: Exactly.

Q: So the construction of this whole thesis is just a meta-commentary on your own work - a ramp form between the extreme of your "natural" unconstrained associative self and the idealized constrained and bisociative self of your work?

A: Just as this conversation is a meta-commentary on that meta-commentary.

Words in Clause	Clause No.	Sentence
12	1	1
11	2	
4	3	
16	4	
8	5	
15	6	
TOTAL: 66		
11	1	2
22	2	
10	3	
37	4	
11	5	
20	6	
31	7	
23	8	
10	9	
17	10	
5	11	
TOTAL: 197		
3	1	3
TOTAL: 3		
TOTAL: 266		

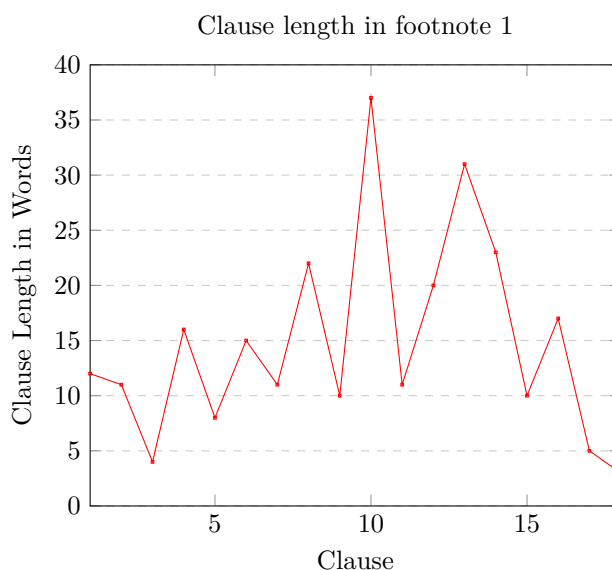

Figure 5.18: Analysis of clause and sentence lengths

Q: So how does this Conclusion work? How did you manage to apply the syntactic structure of that original footnote?

A: I used a linguistic parse tree to analyze that footnote. This analysis can be found in Appendix E.

Q: The analysis is sort of weird. . .

A: How so?

Q: Well, it looks like you do a strange thing as the footnote goes on. You increasingly disregard conventional SVCA clause structure and instead start constructing "clauses" from isolated noun phrases in which all of the information is nested inside the postmodifier slot. Clauses 7 and 8 in Sentence 2 both take a head noun with determiner ("a grass", "a landscape") and then place all of the information as a postmodification of that head noun.

A: Oh.

Q: Were you aware you were doing that?

A: No. Interesting.

Q: So what did you do with that analysis?

A: Well, I picked three linguistic levels, taken from the hierarchy of rank in Figure 1.33 in Chapter 1:

1. Sentences in Paragraph
2. Clauses in Sentence
3. Words in Clause

Then did some analysis according to these categorizations, which can be seen in Figure 5.18.

Q: There's some interesting wave and arch shapes going on there.

A: I know, right.

Q: I guess, if you have a breakdown of the clauses you want to replicate into parse trees then it's pretty easy to just Mad Lib in substitutions for different syntactic elements to create your meaning.

A: Well, not *easy*; imagine trying to pack a drumkit into a Vauxhall Corsa so that you can still play it. Several dozen times. But, yes, that is the basic principle.

Q: And formally? Because the Conclusion doesn't look static - looks a bit like there's a sort of inverse process to the one going on in Robert Fitterman's conceptual writing poetry book No, Wait. Yep. Definitely Still Hate Myself (Fitterman 2014), made from quotations by depressed people on internet message boards and re-arranged into a poetic structure in which the length of lines gradually expands.

A: Exactly, this is another ramp form in which the clause structures of the footnote gradually shrink to the shortest paragraph possible in the English language: a paragraph consisting of a single sentence, which consists of a single clause, which consists of a single word. This can only be a verb in the imperative, such as "Stop!".

Q: So you then algorithmically interpolate between these two extremes over the course of the Conclusion?

A: Yes, I divided every clause into a number of component parts (see Appendix E). These divisions were based upon how much of each clause could be removed whilst still leaving it grammatically correct. In each of the 13 sections of Conclusion, I sequentially reduce the number of components in clauses with the largest number of divisions each section, resulting in a gradual decreasing of syntactic complexity. This process is shown in Table 5.4. the clauses removed each time were based upon their numbering in Appendix E, with lower-numbered components being removed first.

Q: What happens if the clause structure is too short or long for the section?

A: The structure will loop around or halt midway.

Q: There are some parts in italics which seem to break with your system.

A: Oh, yeah. Sections written in italics indicate where often quote-heavy text was unable to be integrated successfully into the syntactic structure. The syntactic process carries on after the italicized sections, from the place it left off.

Q: Apart from that, is the process followed strictly.

At the start of the process I was very strict, so the first two sections of the conclusion use the syntactic structure exactly. Then, as the Conclusion went on, I became looser in its application, partly as a way to find a balance between the subject matter and the increasingly restrictive options offered by the quickly reducing syntax trees. This is partly explained in the Conclusion itself when I talk about how a constraint can function as an ideal parent.

Q: But the clauses aren't kept in the same sentences as in the original footnote, no?

A: The clauses were not kept in the same sentences and slowly shifted over the course of the conclusion, eventually changing so that there was only one sentence per paragraph, to fit with the process.

5.3.2 Words: Tenses of Verbs

Q: But what's up with the Verb Groups? Are they like sacred or something?

A: No, I don't think so. I treat the Verb Groups separately because verbs control tense and I want to have a different process that controls the Conclusion's relationship to time.

Q: Why?

A: Well, the end of a PhD thesis should move from discussing the past to discussing the future. So I want to control the tense of each Verb Group to create a ramp form that moves from far in the past to far in the future.

Q: How many tenses are there anyway?

A: Well, English really only has two tenses; the past and the present - everything else is created through the use of primary and auxiliary verbs. I made this nice diagram in Figure 5.19 that shows how

			Section														
			1	2	3	4	5	6	7	8	9	10	11	12	13		
Sentence 1	Clause	1	6	6	6	6	6	6	6	6	6	5	4	3	2	1	
	Clause	2	6	6	6	6	6	6	6	6	6	5	4	3	2	1	
	Clause	3	2	2	2	2	2	2	2	2	2	2	2	2	2	2	1
	Clause	4	9	9	9	9	9	8	7	6	5	4	3	2	1	1	1
	Clause	5	6	6	6	6	6	6	6	6	6	5	4	3	2	1	1
	Clause	6	7	7	7	7	7	7	7	7	6	5	4	3	2	1	1
Sentence 2	Clause	1	4	4	4	4	4	4	4	4	4	4	4	3	2	1	
	Clause	2	7	7	7	7	7	7	7	7	6	5	4	3	2	1	
	Clause	3	4	4	4	4	4	4	4	4	4	4	4	3	2	1	
	Clause	4	13	12	11	10	9	8	7	6	5	4	3	2	1	1	
	Clause	5	4	4	4	4	4	4	4	4	4	4	4	3	2	1	
	Clause	6	9	9	9	9	9	8	7	6	5	4	3	2	1	1	
	Clause	7	9	9	9	9	9	8	7	6	5	4	3	2	1	1	
	Clause	8	6	6	6	6	6	6	6	6	5	4	3	2	1	1	
	Clause	9	2	2	2	2	2	2	2	2	2	2	2	2	2	2	1
	Clause	10	6	6	6	6	6	6	6	6	6	5	4	3	2	1	1
	Clause	11	1	1	1	1	1	1	1	1	1	1	1	1	1	1	1
Sentence 3	Clause	1	1	1	1	1	1	1	1	1	1	1	1	1	1	1	1

Table 5.4: The number of clause components used in clauses in the Conclusion. These clause components are the ones seen in Appendix E. Notice how the clauses with the largest number of components (in bold) are reduced each section.

these work in verb groups.

Q: And I guess Table 5.5 is a list of tenses that you use in the Conclusion?

A: Well, the conclusion has 13 sections and Table 5.5 shows the 13 main tenses arranged from the furthest in the past to furthest in the future (ignoring conditional forms).

Q: But when I look at the Conclusion, I don't see these.

A: Yes, well this is one of the ideas I had to abandon during the creation of this thesis, along with the application of the typology outlined in Murray S. Davis's (1971) paper *That's Interesting!*, which attempts to define what makes academic propositions interesting. I found applying the constraints on tense too difficult to do successfully and abandoned it after the first few paragraphs. I think this is technically possible but trying to integrate it with all the other processes I ended up using proved beyond my abilities - but, hey - that's experimental composition for you! Failure is always an option.

5.3.3 Words: The Sortes and Random Dictionary Words

Below is a list of words I compiled by turning randomly to different pages in the dictionary and looking for words I did not know. These have then been used extensively in the Conclusion and also sporadically over the length of the thesis. The dictionary was the *Concise Oxford English Dictionary* 2009.

Vade Mecum

embrasure n. 1 an opening in a wall or parapet, used for shooting through. 2 an opening or recess around a window or door forming an enlargement of the area from the inside.

elytron each of the two wing cases of a beetle

embolus a blood clot, air bubble, piece of fatty deposit, or other object obstructing a blood vessel.

embonpoint plumpness or fleshiness, especially with reference to a woman's bosom.

gigantomachy (in Greek mythology) the struggle between the gods and the giants.

Verb Group

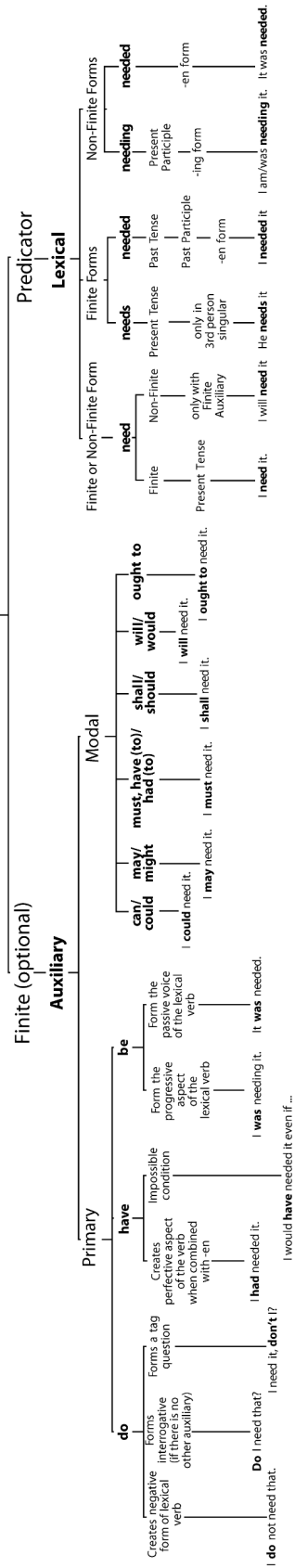

Figure 5.19: Diagram by the author, showing the construction of Verb Groups

TENSE	TYPE OF TENSE	EXAMPLE	MATERIAL TYPE
PAST	Past Perfect Progressive	He had been speaking.	A
	Past Perfect Simple	He had spoken.	A'
	Past Progressive	He was speaking.	A''
	Simple Past	He spoke	A'''
PRESENT	Present Perfect Simple	He has spoken.	B
	Present Perfect Progressive	He has been speaking.	B'
	Simple Present	He speaks.	B''
	Present Progressive	He is speaking	B'''
FUTURE	Future I Simple	He is going to speak.	C
	Future I Simple	He will speak.	C'
	Future I Progressive	He will be speaking.	C''
	Future II Progressive	He will have been speaking.	C'''
	Future II Simple	He will have spoken.	C''''

Table 5.5: A list of possible tenses

gimcrack adj. showy but flimsy or poorly made. n. a cheap and showy ornament.

ginglymus a hinge-like joint such as the elbow or knee.

ginnel a narrow passage between buildings.

girandole a branched support for candles or other lights.

lex fori the law of the country in which an action is brought.

lex loci the law of the country in which a transaction is performed, a tort is committed or a property is situated.

lex talionis the law of retaliation, whereby a punishment resembles the offence committed in kind and degree.

manticore a mythical beast typically depicted as having the body of a lion, the face of a man, and the sting of a scorpion.

marasmus undernourishment causing a child's weight to be significantly low for their age. derivative: marasmic.

opprobrious adj. expressing scorn or criticism.

oppugn to question the truth of something.

oppugnant adj. opposing; antagonistic.

opuscule a small or minor opus.

orbicular 1 having the shape of a flat ring or disc. 2 spherical or rounded.

prestidigitation conjuring tricks performed as entertainment.

preterition the rhetorical technique of referring to something by professing to omit it.

prevenient adj. preceding, antecedent.

scry foretell the future, especially using a crystal ball.

scullion a servant assigned the most menial kitchen tasks.

scumble give a softer or duller effect to (a picture or colour) by applying a very thin coat of opaque paint or a layer of light pencil or charcoal shading.

scuncheon the inside face of door jamb or window frame.

scunge 1 dirt or scum. 2 a disagreeable person.

scunner n. a strong dislike. v. feel disgust or strong dislike.

scurf flakes on the surface of the skin that form as fresh skin develops below, occurring especially as dandruff.

scut the short tail of a hare, rabbit, or deer.

scutage (in a feudal society) money paid by a vassal to his lord in lieu of military service.

sesquipedalian adj. (of a word) polysyllabic; long > characterized by long words; long-winded.

sessile 1 (of an organism) fixed in one place; immobile 2 (of a structure) attached directly by its base without a stalk or peduncle.

se-tenant (of stamps of different designs) joined together side by side as when printed.

table d'hôte a restaurant meal offered at a fixed price and with few if any options.

tachycardia an abnormally rapid heart rate.

tachyphylaxis rapidly diminishing response to successive doses of a drug rendering it less effective.

Taikonaut a Chinese astronaut.

tapetum a reflective layer of the choroid in the eyes of many animals, causing them to shine in the dark.

taphonomy the branch of palaeontology concerned with the process of fossilization.

tardive dyskinesia a neurological disorder characterized by involuntary movements of the face and jaw.

terpsichorean relating to dancing.

terribilità awesomeness or emotional intensity in an artist or work of art.

terricolous living on the ground or in the soil.

tertium quid an indefinite and undefined third thing related to two definite or known things.

terza rima an arrangement of triplets, especially in iambic pentameter, that rhyme *aba bcb cdc*.

tessera 1 a small block of stone, tile, etc. used in a mosaic.

tendentious calculated to promote a particular cause or point of view.

tenebrous dark, shadowy.

tenesmus a continual inclination to evacuate the bowels.

tatterdemalion tattered or dilapidated.

trismus spasm of the jaw muscles, causing the mouth to remain tightly closed.

triturate grind to a fine powder.

uxorial relating to a wife.

vade mecum a handbook or guide kept constantly at hand.

varec seaweed, especially kelp.

varietist a person who enjoys sexual variety.

variorum (of an edition of an author's work) having notes by various editors or commentators

velleity a wish or inclination not strong enough to lead to action.

vena cava each of the two large veins carrying deoxygenated blood into the heart.

venery indulgence in sexual activity.

hamartia a fatal flaw leading to the downfall of a tragic hero or heroine.

consanguineous relating to or denoting people descended from the same ancestor.

auscultation the action of listening to sounds from the heart, lungs, or other organs with a stethoscope.

amyotrophy atrophy of muscular tissue.

boustrophedon (of words) written from right to left and from left to right in alternate lines.

cacoethes an urge to do something inadvisable.

cacodemon a malevolent spirit or person.

ceroplastic relating to modelling in wax.

cerecloth waxed cloth used for wrapping a corpse.

Chapter 5 Bibliography

- Abbott, H. Porter. 2008. *The Cambridge Introduction to Narrative*. 2nd ed. Cambridge: Cambridge University Press.
- Bandur, Markus. 2001. *Aesthetics of Total Serialism*. Basel: Birkhäuser.
- Brown, Derren. 2006. *Tricks of the Mind*. London: Random House.
- Culver, Andrew. n.d. "Anarchic Harmony." <http://www.anarchicharmony.org/People/Culver/CagePrograms.html>.
- Davis, Murray S. 1971. "Tha's Interesting!" *Phil. Soc. Sci X* (1): 309–344.
- Dillinger, Johannes. 2012. "Dowsing from the Late Middle Ages to the Twentieth Century: The Practices, Uses and Interpretations of an Element of European Magic." *Studies in History* 28 (1): 1–17.
- Dinwiddie, John. 2011. "Mewantemooseicday." In *Source: Music of the Avant-Garde, 1966-1973*, ed. by Larry Austin and Douglas Kahn, 235–238. Berkeley: University of California Press.
- Eppler, Eva Duran, and Gabriel Ozón. 2013. *English Words and Sentences: An Introduction*. Cambridge: Cambridge University Press.
- Euripides. 1952. "Rhesus." In *Great Books of the Western World: 5 Aeschylus Sophocles Euripides Aristophanes*, ed. by Robert Maynard Hutchins, 203–211. London: William Benton.
- Ferneyhough, Brian. 1995. *Collected Writings*. Amsterdam: Harwood Academic Publishers.
- Finch, Geoffrey. 2000. *Linguistic Terms and Concepts*. Basingstoke: Palgrave.
- Fitterman, Robert. 2014. *No, Wait. Yep. Definitely Still Hate Myself*. New York: Ugly Duckling Presse.
- Forsyth, Mark. 2013. *Elements of Eloquence*. London: Icon Books.
- Heimbecker, Sara. 2008. "Gesamtkunstwerk, and Utopia." *American Music* 26 (4): 474–498.
- Knuth, Donald. 1982. "Concept of a Meta-Font." *Visible Language* 16 (1): 3–27.
- Kramer, Jonathan D. 1978. "Moment Form in Twentieth Century Music." *The Musical Quarterly* 64 (2): 177–194.
- Malt, Mikhail. 2008. "Some Considerations on Brian Ferneyhough's Musical Language Through His Use of CAC - Part I: Time and Rhythmic Structures." In *The OM Composer's Book 2*, ed. by Jean Bresson, Carlos Agon, and Gérard Assayag, 7–19. Paris: Editions Delatour France / Ircam-Centre Pompidou.
- Merrison, Andrew John, et al. 2005. *Introducing Language in Use*. London: Routledge.
- Ozaniec, Naomi. 1994. *Dowsing for Beginners*. London: Hodder / Stoughton.
- Perec, Georges. 1999. *Species of Spaces and Other Pieces*. London: Penguin.
- Revill, David. 1992. *The Roaring Silence: John Cage: A Life*. London: Bloomsbury.
- Rohrmeier, Martin, et al. 2015. "Principles of structure building in music, language and animal song." *Philosophical Transactions B* 370 (20140097): 1–15.
- Ryf, Robert S. 1977. "B. S. Johnson and the Frontiers of Fiction." *Critique: Studies in Modern Fiction* XIX (1): 58–74.
- Concise Oxford English Dictionary*. 2009. Ed. by Catherine Soanes and Angus Stevenson. Oxford: Oxford University Press.

- Tenney, James, et al. 2010. "Cage and the Computer: A Panel Discussion." In *Writings through John Cage's Music, Poetry and Art*, ed. by Christopher Hatch and David W. Bernstein, 190–209. Chicago: University of Chicago Press.
- Weisser, Benedict. 2003. "... The Whole Paper Would Potentially Be Sound": Time-Brackets and the Number Pieces (1981-92)." *Perspectives of New Music* 41 (2): 176–255.
- Wielgosz, Anne-Kathrin. 1995. "Displacement in Raymond Federman's 'Double or Nothing' or: "noodles and paper coincide"." *Journal of Narrative Technique* 25 (1): 91–107.
- Williams, Emmett. 2013. *An Anthology of Concrete Poetry*. n.p.: Primary Information.

Conclusion

Constraints

And maybe you had been wondering about the why? Of why I had been making things? and amongst paper and ink had been reading the spliced-together style and maybe had been flipping pages to notice again the much-change erratic-writing throughout inkheavy thesis: uneven, sesquipedalian, tone-conflicted as Burrough's cutups; poetic, conversational, academic, continually switching every other paragraph; and just genre-mess that transforms word-vener of coherence slowly into the results of my hamartia.

But realize that firstchapter had been created by writing as *intuitively* as possible, and having seen the frequent digressions, their shifting style as if obese with compound-nouns, as if the infinite footnotes could justify this; more like a warning against intuition, its sins of indulgence, not like the need for some self-control or the delayed gratification of my pleasure or the necessary compositional constraints for my intuition as it sprawls like infections across works with an undisciplined intensity it cannot stop; these constraints on all scales, with choices slowly reigned in - time fragmented across the listening now, across the composing-then of pastdays slotted between the needs of our animalness; these times that are never really matched but of a type that needs to be of a parity made so careful and controlled, with our rules from which indulgence could never escape; these rules which control me and the pacing and the discrepancies of time and the narrative and my intuition and my ever-writing composing; the constraints as if shackles always clamped and hand trapped but always there behind the successful works, constant, on papers scrawled to blackscratch scattered across that woodtop (everbrown), something for a piece, maybe?

A formal constraint.

Self-Control

And finally you know about my intuition. Of how it ruins things. As if behind work and style lies some good taste but eventually digging down to find only the lastbeer dregs of burnt-tongue flavour; misguided, confused and delusional, all penwielding poised, bodgehanded, stubborn, inept, desperately trying again firstchapter style and, honestly, writing that drives patches of prose nearly to the edge of their absurdity.

But wanting that firstchapter-footnote-prose-excitement re-created with its energy underneath, pulsing; and seeing my creativewriting limits, so clear flaggedup as if tapetum-sparkled in wood-dark, as if that thesis vision had disintegrated here; yet with *formal compositional constraints* underneath prose-skin, those tables, below, scrawlsteering, not like my alltoohuman blindness to the future and the myopic viewpoint of the present and my pathetic, intuitive inability in this thesis to write all with style as similar as that third first-chapter-footnote. The Kyoto agreement on climate change like a formal compositional constraint, its nature, futurefaced, constraining impulses;

Form is like our impulse-control, really, through its limitations on actions of ourselves, forced into a confrontation with our subconscious ...

Control Theory is an idea from criminology which posits that "crime is natural and conformity is the area that requires explanation" (Marsh et al. 2006, 107). Control theory ultimately explains criminality as resulting from a lack of self-control due to "the breakdown of the socialization process" combined with the opportunities for criminality (Marsh et al. 2006, 107), in other words "If the opportunity to commit a crime arises then the person with low self-control will commit it, whereas the person with high self-control will not." (Marsh et al. 2006, 108). . .

Crime is truly natural and from a vulnerability that results from a failure: forsaken by a socialization process through which self-control is slowly inculcated; a self-control which is socialized and is artificial and an invulnerability to temptations and law-abiding. These formal compositional constraints, behindscenes, are "self-control"; and still there with reduced crime-opportunities, composed by forms constraining the options, preventing that compositional crime-committing. History of our violence, certainly: "Self-control has been credited with one of the greatest reductions of violence in history, the thirtyfold drop in homicide between medieval and modern Europe." (Pinker 2011, 592)

The Civilizing Process (Elias 1997).

Formal Compositional Constraints as Parent (Confessions of a Mechanick Preacher)

And perhaps you ask of the why? of why I constrain things? And Hirschi and Gottfredson noted the family role, always socializing to strengthen, especially that crime-inoculating self-control of childhood discipline (Geis 2000): do, donots and shoutnots in boxmall carparks. And childlike, playful, open, undoubtedly, are art-making necessities, then possibly "compositional socialization" projects the composer's relationships to their parents as the constraints

And creating the constricting formal compositional constraints, their parental nature as if homeworkwatching at predinner, as if their everchecking regulation could reign-in our behaviour, so short of sight, our actions so childish, like the fireplace handstick of the toddling, or the stairedge wander of the tinyfooted; and these formal compositional constraints as our parents as they arise from *introjection*.

Introjection is a term "used in psychoanalysis to denote internalization, particularly of deeply-held moral values (e.g. those of parents)" (Stuart-Hamilton 2007, 146). Freud describes how the introjection of the parental relationship to the child occur at the termination of the Oedipal Phase of psychosexual development, wherein "[t]he authority of the father or the parents is introjected into the ego, and there it forms the nucleus of the super-ego, which takes over the severity of the father and perpetuates his prohibition against incest, and so secures the ego from the return of the libidinal object-cathexis" (Freud 2005, 399).

According to Maccoby and Martin, there are four types of parent ...

Authoritative: *high expectations of the child's behaviour and maturity, firm negotiated boundaries, good communication and high levels of warmth and responsiveness to the child's needs.*

Authoritarian: *high expectations of the child's behaviour and maturity, set boundaries and more severe disciplinary measures, poorer levels of responsiveness and communication.*

Permissive: *good communication, warmth and responsiveness, low expectations of behaviour and maturity, fewer and less consistent boundaries or disciplinary measures.*

Neglecting/uninvolved: *poor levels of responsiveness and communication, low expectations of behaviour and maturity, lack of boundaries and controls.* (Kay 2007, 13-14)

The projection of our introjected parental relationships: our formal constraints, Fosdyke-like, running parallel. I posit that a composer's work, potentially, through the arrangement of its form, correlates with the style of their upbringing. My constraints, that stay resiliently strict, of a discipline that reflects back an authoritarianism buried as deep and unscrubbable as a warm Ribena, an introjection of my own?

A work which is loosely-structured and written intuitively, and uses few constraints, and has an undisciplined form; no discipline, as if its author has low self-control: a more permissive upbringing.

And still there, our formal constraints, mirroring, shadowing the socialization process that children go through (and which is so key to preventing criminality), in which "the 'disciplining' of children's bodies can be seen in the use of timetables and mechanistic routines in which time is demarcated to such an extent that the immediate lived needs of young children are subordinated to the imposed timetabling of practitioners" (Albon 2012, 161-162). Libidinal desire into regulated temporal constructs.

A similar thing.

Formal Compositional Constraints as God

With parental authority introjected and forming the centre of the super-ego in the termination of the Oedipal Phase of psychosexual development, this construct can then be projected outwards not only as the authorial constraints of form, but also as God (i.e. God as father-figure (Beit-Hallahmi and Argyle 1975))

In fact, the talk of self-control and its relation to formal compositional constraints might bring to mind writings such as the famous and influential 18th Century treatise on the dangers of masturbation: Onania, or the Heinous Sin of Self-Pollution, and All Its Frightful Consequences, in Both Sexes, Considered. With Spiritual and Physical Advice for Those Who Have Already Injur'd Themselves by This Abominable Practice, published in 1716 (Stolberg 2000, 37).

We might then presume that any formal compositional constraint asks the composer to rather "undergo the severest discipline, to keep under the body for a while, than to to be tormented in soul and body for ever" (Stolberg 2000, 45) than to suffer gonorrhoea ex frequenti mastupratione (p. 49) or some other malladie deriving from "draining away all the radical moisture" (p. 41), "their generative faculties weaken'd, if not destroy'd in the prime of their years, a jest to others, and a torment to themselves" (p. 41).

Or perhaps, even, a more general type of religious mistrust of the body, as seen in John Bunyan's The Pilgrim's Progress:

Pru. Do you not yet bear away with you some of the things that then you were conversant withal?"

Chr. Yes but greatly against my will; especially my inward and carnal cogitations; with which all my Country-men, as well as myself, were delighted; but now all those things are my grief; and might I but chuse mine own things, I would chuse never to think of those things more.

(Sim 1987, 321)

However, Hirschi and Gottfredson were careful to distinguish Control Theory from possible religious implications it might have "In suggesting that law-breaking, rather than law-abiding, behaviour is natural, Hirschi is not restating the 'classical' theoretical position that crime is an expression of free will - people are not born wicked or 'criminal'" (Geis 2000, 108).

The Protestant Work Ethic

But perhaps Calvinism has an influence, an influence on why we make things? And *Onania* and *The Pilgrim's Progress* have had a real enough influence and perhaps, digging down, to find only the Protestant principles of the construction of modern western morality and capitalism; ascetic, sessile, tatterdemalion, in *The Protestant Work Ethic*. Max Weber, sociologist, philosopher, writer, obsessively scribbling about capitalist tachyplaxis and suddenly, *The Protestant ethic and the spirit of capitalism* proposes ascetism of Protestantism as the formation of Capitalism (Giorgi and Marsh 1990, 500). But maybe compositional formal constraints are like the theories of Weber and manifest that much-written Work Ethic, its silent everpresence beneath atheistic surface, tenebrous, as if its ancient values ovenencrusted.

Exactly as the paper of Giorgi and Marsh (1990), that hint of stillfunctioning, found in Western Europe, and the majority Protestant Countries, and in those who had been educated for longer (Giorgi and Marsh 1990, 514-515). My composing, in England, its set-up so post-Reformation, keeping Protestant; me composing in a Higher Education Institution, now, as if that demographic of Giorgi and Marsh was something I was trying to attain. An influence that was always there, but of a type that hides below the culture, mixed so deepdown and nevertalk, with uselessness which we breed from our valleity.

Completest aesthetics at their worst can be lazy and boring and neurotic, an approach as if Work-Ethic-Borne and it cheats but still there, with Marxian labour-hours, embedded, its output valorized through work, shorn-up in sub-prime style; religion with your wealth, perhaps?

A work ethic.

In fact, one could see Completestism as a stand-in for Calvinism when, in 1662, Anglican archbishop, man of moderation, and author Simon Patrick praised "that vertuous mediocrity which our Church observes between the meretricious gaudiness of the Church of Rome and the squalid sluttery of Fanatick conventicles".

The Perfect Parent

And now you wonder about the constraints, about how we choose them because “by intuition and feeling” isn’t a good enough answer, and eventually digging down to find instead these formal constraints upon composing intuition, restrictive, obsessive and limiting, cross-referencing, table-checking, slow-writing, obsessively searching for an ideal parent and then an ideal form that fulfils needs of composing, immaculately, as the best of parents.

Kay points out that “Authoritative parenting approaches have the most positive outcomes for children’s behavioural development in terms of mature behaviour, good social skills, emotional stability and self-control, and effective learning skills” (Kay 2007, 21). From our earlier discussion, we know that authoritative parents set “high expectations of the child’s behaviour and maturity, negotiate firm boundaries, have good communication and high levels of warmth and responsiveness to the child’s needs.” (Kay 2007, 15-16)

And know that constraints originate from projecting the perfect parent, and seeing the authoritative parent of firm boundaries, with expectations for aesthetics of a high level, setting firm boundaries *zoals een ouder ideaal* as our police, or immaculate parent as our God, or a perfect, authoritative parent of our art as we play.

Stylistic Control

But perhaps you recognize these processes and how they seem familiar, as if originality and uniqueness was a real enough goal, but now searching around to find, of course, the usual suspects of literary processes; experimental, strange, languagemangling; smudging, palmsweating, boustrophedoned, terza rima’d, obsessively scribbling, and especially writers that constrain processes of writing such as *Oulipo*, and shoutout that syntax deconstruction beyond meta-created by Craig Dworkin in *Parse* and

acknowledging the North Americans, their conceptual writing like Bach fugues polyphonicizing language, especially like those works of Christian Bök, that hint of everobsessive; not like my writing work of this thesis and the composer viewpoint of its processes, the process of the changing of things, as time passes. Writer's processes unchanging through the pages endward, through the paragraphs in stasis of dynamism, stuck; some writing that was never truly moving but of a process that stays in its place, locked so fixed and timeless: the process of Perec's Es in *La Disparition*, and always missing, and ever absent; my processes as if time always moves and changes things. And now here in sofucked sentences, changing, through points interpolated between, shortening. Strangeness in this course, maybe?

A piano trio?

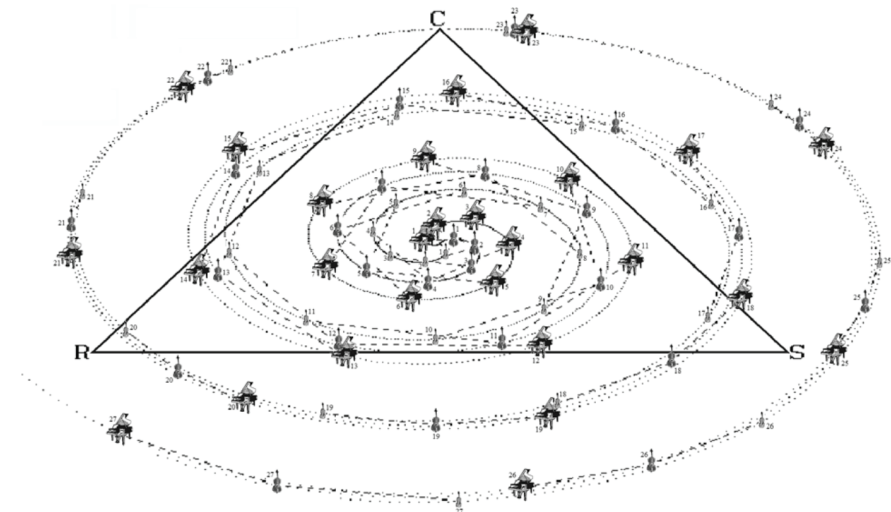

Figure Conc.1: Diagram showing the process behind Clarence Barlow's 1981: "piano trios by the three composers Muzio Clementi (*La Chasse* in C, 1788), Robert Schumann (*Trio No.2* in F, 1847) and Maurice Ravel (*Trio* in A minor, 1914), respectively, one movement each, formed the point of departure for this composition. The compositional process is as follows. Each of the three instruments, violin, cello and piano, describes an individual spiral starting at the centre of an equilateral triangle with the composers Clementi, Schumann and Ravel at the apices marked "C", "S" and "R" ... The numbers alongside the images of the three instruments are score markers, multiples of 18 bars. The distance of the instruments' position from an apex at any given time is related to the amount of the corresponding composer's music in the general mix. Thus, at the beginning of the piece, at the triangle centre, 33% of the notes in the score come from each of the three composers. However at bar 410, just to the left of marker 23, all three instruments are together at the Clementi apex, meaning that the score contains 100% of his music at this point, together with a small percentage of the music of the other two composers, more than zero since they are not infinitely distant." (Barlow 2012, 8)

And perhaps Clarence Barlow's *1981* (for violin, cello, and piano) has the answers for why I interpolate things? As if between A and B lies a something else, and never replicating directly, to generate instead, an aesthetic weirdness between fixed points, half-A, half-B and notboth; transforming, changing, shifting, slowly negating all internal essences and eventually something that makes strangenesses of style inexorably into a newness.

But know that style can be used for validating the work, so experiment-like and becomes the "scientific" *control*, its suspicious easyanswers outside upthumbed without content, as if the aesthetic purpose was to be surface-found. Rather like the writing of Christian Bök with style-model for every poem, like an easy standard of comparison or a quantifiable success or a redeeming, constraint-saving metric for the experiment. A poem as an experiment, its set-up such that it can never fail.

A quotation, perhaps erroneously attributed to Kagel, is that "experimental music should be an experiment it is impossible to validate".

I want, despite my portfolio, however, beyond the constraints underneath pieces, amid processes working, a style that is never directly copied but of a type that emerges out of the experiment, moving toward newness and strangeness, a style that undermines itself and its validation and its function as control, and your expectations, a style as if it never stole from the dead. And sometimes there, in successful pieces, slotted, in portfolio sparkling between failures, experiments without a style, almost.

An achieved goal?

"In our town," a subscriber wrote to the Gentleman's Magazine in 1794, "the venerable remains of the dead 'hearsed in earth' have burst their cerements,' and been exposed to every insult

and indignity which the unprotected can experience.”
(Sanchez-Eppler 1988, 422)

Is that my portfolio? Pieces as gravestones, scores as epitaphs. Yet this is not real mourning, as “the ready-made epitaph marks only the form, not the feeling, of commemoration, allowing affectation to stand in the place of affection” *(Sanchez-Eppler 1988, 428)*.

Yet, though the gravestone is presented as the parent of poetry, it too is secondary, merely a marker gesturing towards the dead body decaying beneath it. The epitaph “presupposes a monument” and the monument presupposes a body. Wordsworth’s *Essays* are continually repeating this movement from the inscribed word to the unlettered “external sign” of the monument and finally to the corpse.

(Sanchez-Eppler 1988, 428)

I must leave the corpses in the earth, apply my own 1832 Anatomy Act and end the body-snatching.

In 1281 the Icelandic national assembly, or Alþing, ratified the

Jónsbók. This new lawbook had a prohibition against theft, with an exception "for a man who steals food because he is not able to earn himself a living by work, and who steals out of starvation. That theft is by no means punishable." (Stein-Wilkeshuis 1984, 10-11).

I am not yet starving.

What Is Good Form?

There is one way to differentiate good form from bad form:

Listen to a piece of music and, when it has finished, ask yourself: "Why has this piece ended?"

Meaning not "I wish this piece could go on forever" but "what has happened in the x minutes that I have been listening that necessitated the piece to stop at this moment?"

What were the causal links that led to its termination at this specific point in time?

If you can find a satisfactory answer to this question, the piece has good form, if you cannot it has bad form.

I seek to ensure all my pieces can satisfactorily answer the question of why they have ended.

...the end is built into the beginning...

- Synecdoche, New York (Kaufman 2008)

Music-as-Rhetoric/Dialectic/Logic

And maybe western art music has moved through three paradigms from Aristotle, I argue; as if principles of argumentation undergirded the music-making process, and probably over-analyzing to find there a tripartite division of convenience:

Rhetoric, which studies the process of argumentation,

Dialectic, which studies the procedure of argumentation,

Logic, which studies the product of argumentation (Blair 2012, 149).

Popular, practiced and citable, certainly conceptualized around the Baroque period - *music-as-rhetoric* which reveals itself in Haydn's work (see *Haydn and the Performance of Rhetoric* (Beghin and Goldberg 2007)).

In this paradigm the "enthymeme, or rhetorical demonstration, underlay the Affekten; contradiction in music was meant to exert the same oratorical force as rebuttal in debate, but whose object now was the listener's submission to an Affekt rather than to an argument" (Greenbaum 2008, 344).

The Music-as-Rhetoric period of the Baroque gave way to the Music-as-Dialectic period of the late-Classical and Romantic Period, embodied in the sonata-allegro form, with its emphasis on development by contradiction, mirroring the dialectic "strategies (to be used in dialogue games) for proving or refuting (either by deductions or by generalizations) propositions about which disagreement is reasonable and there is a prospect of success" found in Aristotle's Topics (Blair 2012, 154).

The use, by Forkel, of the terms Hauptsatz (thesis) and Gegensatz (antithesis) to

describe the main and contrasting theme in the sonata movement in 1788 pre-dates Hegel, although Hegel did use similar language in his Vorlesungen über die Aesthetik (1820-1829) (Greenbaum 2008, 344).

The music-as-logic period occurred in the Twentieth Century with its increasing scientism, probably starting with the arrival of Werner Meyer-Eppeler at the Darmstadt Summer Course in 1951 and the dissemination of his ideas connecting music with information theory (Iddon 2013) (see esp. his article Musical Communication as a Problem of Information Theory in Volume 8 of Die Reihe (Meyer-Eppeler 1968)).

And forget those paradigms shifted beyond privileging the speech of humans, and forget the *redendes Prinzip*, that "oratorical" or "speaking" principle in the musical concepts which rule us (Greenbaum 2008, 344); instead with the idea of privileging a type of causality; like our contemporary musical forms and their subtle, consanguineous manifestation of consequence.

Death and Pleasure

And undoubtedly you know of the logic of death...

All men are mortal
Caius is a man
Therefore Caius is mortal
-Kieswetter, quoted in (Krouglov 2011, 62)

With a narrative emanating from our Freudian desires, and always found there, located there - the theory of Peter Brooks: narratologist, writer, literary theorist, uncovering little stories and most notably *death drive* that powers narratives: "All narrative may be in essence obituary in that ... the retrospective knowledge that it seeks, that comes after, stands on the far side of the end, in human terms on the far side of death." (Brooks 1984, 95).

And know that narrative is like manifesting the gigantomachic battle of drives and encoding the everpresent death drive, its want of terricolous quiescence like a house-guest who never leaves; completely unlike the nature of the pleasure/reality principle, that need for everliving (Felluga 2015).

According to the dynamic model of Freud's *Beyond the Pleasure Principle* "we live in order to die, hence that the intentionality of plot lies in its orientation toward the end even while the end must be achieved only through detour" (Brooks 1984, 108). This detour, as the mechanism of repetition, directly embodies the pleasure principle. Drives fighting with each other, constantly, in our narratives: a drive that is ever quickly moving and toward a termination: narrative dies/concludes; a drive that wants repetition, and its pleasure and the continuation of plot and its survival; two drives of wholesale embrace of death or the endless repetition of the present, but most truthfully, despite Brooker's ideas, written, so eloquent; drives exist in my work separately.

An idiosyncratic tic?

And honestly I do not know about the reasons for this. As if my works do not have a real narrative, and rather worryingly seeing only the drives of Freud split, separate, unconflicted, infecting different pieces and somehow, music that has one drive only and finding that my works are either moving toward their termination unimpeded, or repeating the same thing, the excessive looping as if the material wanted to never die, like the *variation form* of *Augenmusik IV*, those loops of neverending, or like the unstoppable, deathneeding movement of *ramp form*.

Chapter	Subject	Research	Form
1	<i>Quantization</i>	<i>Extreme Associative</i>	<i>Variation</i>
2	<i>Divination</i>	<i>Normal Associative</i>	
3	<i>Completism</i>	<i>Normal Associative</i>	
4	<i>Form</i>	<i>Bisociative/ Associative</i>	
5	<i>Process</i>	<i>Bisociative/ Associative</i>	
<i>Conc.</i>	<i>Constraints</i>	<i>Extreme Bisociative</i>	<i>Ramp</i>

Ramp and Funnel Forms: A to B is a Story

And always *ramp and funnel forms* build in death, as if born to die; and embedded there, we find the hamartia of heroes deteriorating in Ancient Greek tragedy, fatal flaws that mirror our form (Booker 2004, 187) and create a *terminal narrative* embedded through planning and composing the *linear form*, its ending as a causal necessity

existing at an extreme, so like the utterances of oracles at those ancient, tragic openings: the witches at their meeting with Macbeth, hail him "Thane of Cawdor" and "king hereafter"; Teiresias's warning to Oedipus (in Sophocles' *Oedipus the King*) that "he shall be found at once brother and father of the children with whom he consorts; son and husband of the woman who bore him; heir to his father's bed, shedder of his father's blood." (Sophocles 1952, 103)

The sense of a beginning, then, must in some important way be determined by the sense of an ending. We might say that we are able to read present moments-in literature and, by extension, in life-as endowed with narrative meaning only because we read them in anticipation of the structuring power of those endings

that will retrospectively give them order and significance of plot.
(Brooks 1984, 94)

An approach to form that is of maximal predictability, a mirror which reflects life: the process for how people enjoy existence by just focusing on ever-present now, ignoring, knowledge of our death, however.

The little things?

And perhaps composers' forms show their acceptance, and morphology reveals deathfears, and digging down we find composers of wondering, fragmentary forms rejecting their mortality? and compositions that abandon narrative closure are in denial ...

Let A be one extreme of a parameter (i.e. birth).

Let B be the other extreme of a parameter (i.e. death), a point at which it is impossible to go further, a logical termination point of the work.

A→B is then a terminal narrative.

And terminating a particular work, a parameter like its pitch being used, simply at the top of the instrument that high, final note occurs: the ending via the instrument's limits, *Augenmusik VI: Asch*-like terminating there.

Physical properties halting these processes, through their

boundaries. A beach that shone so bright; a labour that lit itself, a work, *Digging Piece*, made in collaboration with Ana Lemnar, Grzegorz Marcinak, Maya Verlaak, and Adam Basanta, and still there a night audience, digging; piece for a beach, however.

An empty beach.

And slowly they unearth the lights beneath sand, buried earlier and digging down to find sirens under beach, calling softly upwards and work that ends when all are dug up and see that darkbeach punctured with embrasures of light and sound (see Figure C.2) after telling the seablashed audience, with shovels to that way walk, listen, and dig where sound seeps up.

Or like the B of overlaying, with the parameters stacked, with linear processes as their guide, their termination, finally happening at B, all reaching that no-return point. This technique, that was used in *We Doubled Down The Base Camps*, four parametric interpolations occurring over the 12 minute piece:

1. Lowest pitches on the instruments → highest pitches
2. *mf* → *ppp*

3. normale → sul tasto
4. slow → fast

Determinism and Predesti- nation

And slowly we move toward death, as if $A \rightarrow B$ is a story, and mirroring us to show only our journey towards emptiness, embracing death without detour, and pleasure that negates ending, and know these works play with determinist ideas, and seeing the Calvinist concepts of predestination, as if I had planted them intentionally.

The concept of philosophical determinism arises "from a strict interpretation of causation ... that every state of affairs is determined by the situation preceding it and constitutes a link in an unalterable chain of events" (Rohmann 2002, 100).

In other words, it is a belief that, in its most extreme version, an individual has no free will, their behaviour being the result of a set of biological, social, psychological, physical, economic, geographical etc. systems over which they have no conscious control.

"Suppose I were faced with a choice between vanilla and chocolate ice cream, and I chose vanilla. Could I have chosen chocolate? If determinism is true, then we can find some causal law linking the choice I made with antecedent conditions such as my upbringing, my tastes, my moods, and so forth."

(Dworkin 1970, 6-7)

Much of my work (often unconsciously) seems philosophically determinist; our agency, in this world, without substance, instead, delusion of choice. Humans robbed of any power.

My works, as if choice is presented but then brutally undermined, crushed; appearance of some openness maybe, an illusory choice.

And, really, human beings have no agency, as if appearance was enough and digging down to find the earlier work by me: Hans Haacke-inspired systems works like the *Parameters* series, and see that veneer of openness and choice, and watch all player-“decisions”, their circumscription within systems controlled by chaotic feedback, completely beyond their individual control.

Like *Parameters I* (2012) for string quartet (Figure Conc.3) and *Parameters VII: Infectious Diseases in Cattle* (2012) for four dancers; the series at its extreme, its determinism, Cage and John Kerrich-like in *Parameters IX: The Obscure Moon Lighting An Obscure World* (2012), only instruction: "Flip a coin to decide if you will

flip the coin again”, and *Economics* (2010, revised in 2017 - see Figures Conc.4 and Conc.5), a piece which replicates free-market capitalism; and *Conditioned* (2013), with its performer Pavlovian-conditioned; and still there in *Selfhelplessness* and *Cipher for the Lighthouse Twins* (see Chapter 2); nothing of your choice, maybe?

Open scores are only open if you believe that humans have free will.

And perhaps you remember about Beethoven?: That research found in Chapter 4, and looking again to find the normal-curve so mediocre,



Figure Conc.2 Image of the work *Digging Piece* made in collaboration with Ana Lemnaru, Grzegorz Marcinak, Maya Verlaak, and Adam Basanta. From the "Sand Songs" event organized by *iii* (<http://instrumentinventors.org/production/sand-songs/>) at the Zandmotor, The Hague, June 18th 2016. Photo by Pieter Kers (<http://beeld.nu>).

disappointing us; and creativity that is constrained, and knowing his keyboard did it. And stripping the illusions of choice, its temptations, from our music-making.

And like the fixed-media work *MG3250 Plays Cornelis Cardew's "Treatise"* (2015), like *Treatise's* "openness": the realization, as a warning, graphic scores, playing into the dull predictability of human behaviour. Printer printing out the score as if music, a sound that is more interesting (Figure Conc.6).

In his consideration of the differences between Bunyan's Calvinist The Pilgrim's Progress, and archbishop Simon Patrick's earlier, but Anglican The Parable of the Pilgrim, Sim locates the difference between the two in Patrick's narrative avoidance of spiritual conflict and contradiction with Bunyan's conflict-oriented narrative which directly confronts the paradoxes of Calvinist predestination, stating that "the solitary nature of so many of Christian's [the main protagonist's] trials tends to encourage self-reliance and a sense of one's own individuality ... The more Christian seeks to bind himself the more he succeeds in individualising himself." (Sim 1987, 320)

This individualizing, as if composition also does this; and still there, in formal compositional constraints, catalysing; free will of the

Variation Form

And surely variation
form is repetition?

*Repetition, in its usual
narrative conflict with the
death drive, allows the
creation of meaning whilst
retarding "the pleasure
principle's search for the*

gratification of discharge, which is another forward-moving drive of the text." (Brooks 1984, 103):

Crucial to the space of this play [between the two drives] are the repetitions serving to bind the energy of the text so as to make its final discharge more effective. In fictional plots, these bindings are a system of repetitions which are returns to and returns of, confounding the movement forward to the end with a movement back to origins, reversing meaning within forward-moving time, serving to formalize the system of textual energies, offering the pleasurable possibility (or illusion) of "meaning" wrested from "life".

(Brooks 1984, 108)

And comparison is used,
and illuminating the main
musical centre, finding
absence, variations
crowding; and
nothingness that sits
central, and see those
c o n s t a l l a t i o n s
surrounding, and seeing a
central emptiness.

Much like this
conclusion: a set of
variations, ways to
interpret my practice, a
core similarly as empty?

My work which is about
psychology. My work
which is about parents or
Calvinism, God, or
determinism, or
children's storytelling, or
historiography, or
medieval Icelandic law ...

And perhaps you ask
why? and think a lack of
information prevents
knowledge of an object.

Like pieces that are
named *untitled*. But
know an approach more
obscurantist.

And approaching it
infoglut, more like a
toomuchness:

*This might be
described, following
the philosopher Slavoj
Zizek's invocation of
Freud, as the
"borrowed kettle"
alibi of power. The*

term refers to the multiplication of contradictory narratives refuting apparent facts: confronted with the fact that a borrowed kettle was returned with a hole in it, the person accused of breaking it responds with several mutually contradictory excuses: "there was already a hole when I borrowed it; the hole wasn't there when I returned it; I didn't even borrow the kettle."

(Andrejevic 2013, 6)

Too many narratives,
identity obscured.

Multiple stories told by
The Joker.

Conflicting stories told of
his facial scars in *The
Dark Knight* (2008)

Multiple names given.

Multiple stories given.

Who are the young men?

They torture the family in
Michael Haneke's *Funny
Games* (1997).

Call it *Four Yorkshireman
Variation Form*.

Narrative escalation
happens in that Monty
Python sketch.

The Lonely Island
undermine narrative in
Like A Boss.

Don't write one title.

Write 48 titles.

Start a piece 48 times.

Augenmusik IV: Paperwork
does this.

It dies 48 times.

A variation form.

Gratis deo.

Stop!

P

Viola $1\ 1/2$
 Vln I $1\ 1/2$
 CUE $1\ 1/2$
 Vln II $1\ 1/2$

continuous
 step
 step
 continuous

(a) Excerpt from *Parameters I* (2012) for String Quartet (Rehearsal Mark P). Each box is a different instrument that shows how you should react to specific parameters played by another member of the quartet.

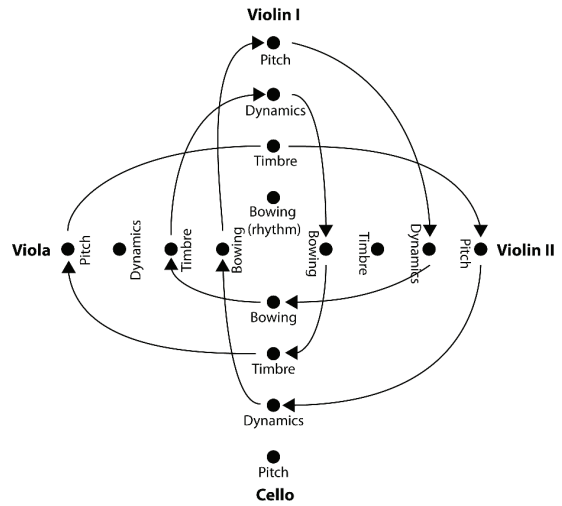

(b) Sketch showing the interaction between instruments for the excerpt on the left. The sketch shows how each instrumentalist is mapping parameters played by another instrument onto their own. Notice how the interactions are arranged in one long cycle, creating a chaotic feedback system over which no single player has control.

Fig. Conc.3 Comparison of sketch of *Parameters I* and finished score.

Economics (2017 Version)

For 6-10 players of any instrument with controllable pitch, volume and dynamics
Written for the *Kick The Can* protest concert

Set-up

All players should sit or stand with page 2 of the score in front of them.
All players should be able to reach everybody else's page 2.

"In art as in life, those with the most money control the cultural agenda"

David Pocknee

Den Haag, March 2010
revised Den Haag, April 2010
and Manchester, June 2017

Instructions

The circles on your page 2 indicate how you should modify the sound you are playing.
When money is placed in one of your circles you must modify your sound in that way.

e.g. if 5 Euro Cents are placed in your **Dynamics: Louder** circle, then you must play louder.

Speed is the time between the attacks of notes. The amount of time you sustain each attack for is the **Duration**.

The higher the amount of money placed in a circle, the more you must modify your sound.

You can place any amount of money into another player's circle at any time in the piece.

Money in your circles can be placed in another player's circle.

However, you cannot move any money *into* your own circles – instead, you must wait for the market to deliver it.

Performance

All players empty any money in their pockets into a pile in front of them.

All players start by playing sounds:

in the middle range of their instrument,

mezzo piano,

every quarter-note at around $\downarrow=80$, unsynchronised with the other players,

with each note lasting half of the duration between attacks (i.e. one 8th-note at $\downarrow=80$).

After the first piece of money has been moved, players have the option to slightly vary their parameters.

Small variations within all parameters are allowed,

e.g. pitches can be a collection of alternated pitches in the required range.

However, these variations should be small enough such that

even the addition of the smallest piece of currency will still result in a noticeable change.

Pitches need not be equally-tempered.

Chords can be used, but only if all participating instruments are capable of playing chords of that size and dynamic.

The piece can finish upon a monopoly being reached, stasis, chaos, systemic collapse, or a fixed time-limit

(5-10mins has been the average performance length so far).

It is best to make a note of how much money you put into the piece before starting. This prevents fights.

Players can ask the audience for money. This is a form of public subsidy.

This piece can also be performed using any money substitutes, such as: alcohol, property, or sexual favours.

My Suggestions/Things to Consider

Avoid a staid, measured performance;
you are participating in a
dynamic, chaotic and unpredictable system.
But don't try to make it funny.

In a DEN HAAG A££ \$TARS\$ EN\$EMBE££
performance on 7 June 2010,
at Studio Loos in The Hague,

the audience organically got involved
and started competing with each other
and the performers, placing their
credit cards, car keys, wallets etc.
in the circles on the performer's scores.

In the audio recording you can
even hear the Zoom recorder being
picked up and used as currency.
It was beautiful chaos.

This happened naturally, though,
through creating an open, welcoming and
anarchic performance environment.
Don't try and force this outcome.

Fig. Conc.4 The score of *Economics (2017 Version)*, page 1.

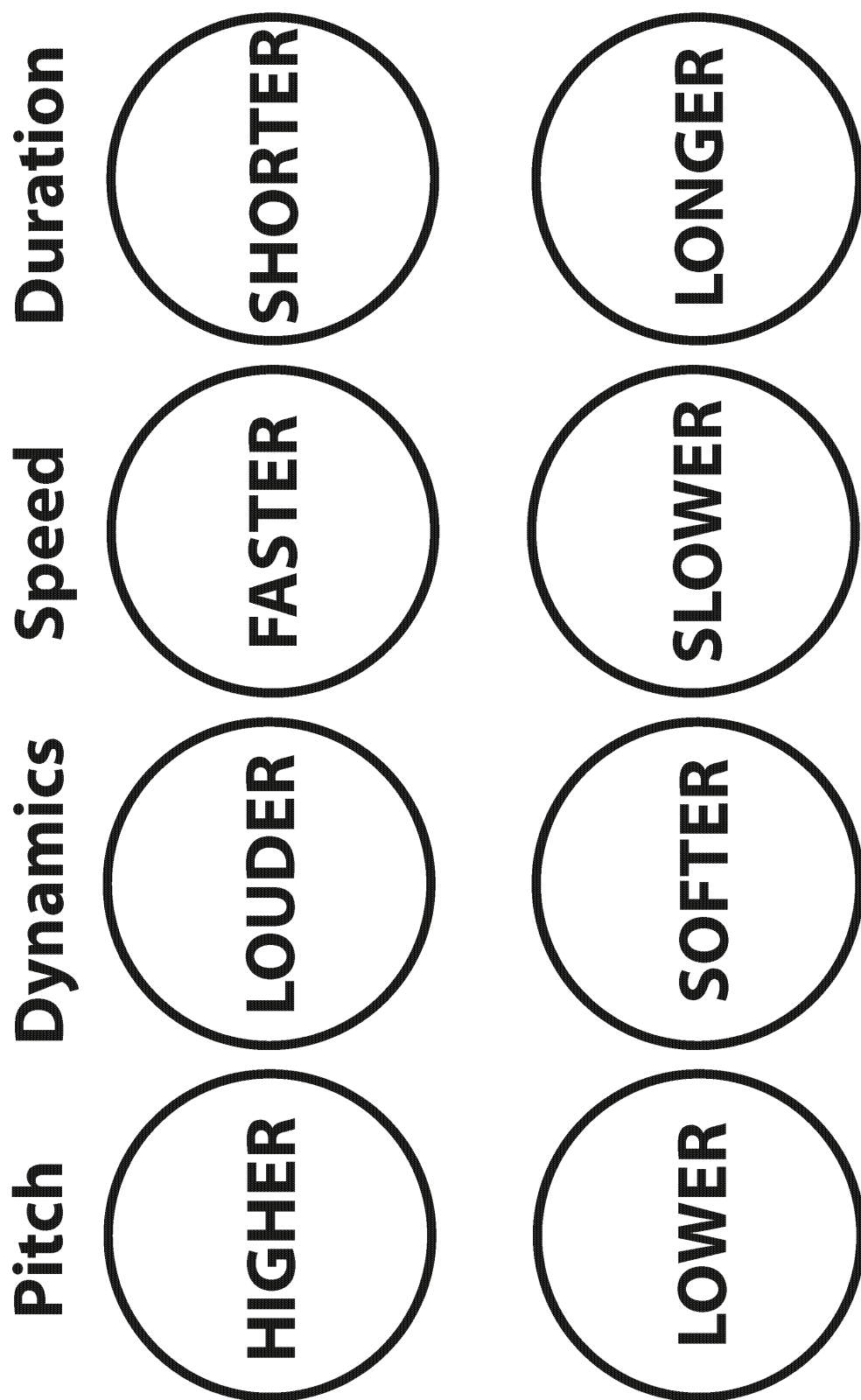

Fig. Conc.5 The score of *Economics (2017 Version)*, page 2.

Cornelis Cardew's "Treatise" is an immense graphic score.
 It is 192 pages long and comes with no instructions on how to read it.
 It fluidly moves between abstract shapes and conventional musical notation,
 forcing the performer to question their received notions about both,
 as they try to make sense of the score.

"Treatise" was designed for humans.
 Its raison d'être is playing in the middle-ground between what is and is not represented.
 Cardew wrote the work with his improvising ensemble AMM in mind.
 So,
 is this recording a valid realization of the work?

This is a recording of a printer performing a piece of music.
 Perhaps a better audience for it might even be other printers,
 rather than humans.
 It is a non-anthropocentric performance,
 in that it refuses human taste in favour of that of a non-human.

Sure,
 we have music made by machines already,
 but they are always designed to make music that suits humans.

There's no trickery here,
 it's not like those internet videos where someone gets computer hard drives to play Radiohead's "Nude",
 this recording is just the sound of an inkjet printer printing a pdf of Cardew's "Treatise" until it runs out of paper.
 There's no special programming,
 and no attempt to get the printer to "play" the work in a way other than the way that naturally happens when you press "Print".

There is something about an inkjet printer that seems to suit a realization of "Treatise" so well.
 Human interpretations of "Treatise",
 as with most interpretations of graphic scores,
 tend to highlight the inability of humans to imagine anything interesting or surprising,
 even with a beautiful image in front of them for inspiration.
 So it is refreshing to hear a performance which doesn't even try.
 In fact,
 although it lacks conventional,
 human "imagination",
 its repeated,
 yet irregular and slowly changing,
 swoops over the page show more creativity than the usual "x=time/y=pitch" mappings of the work.
 In this interpretation,
 every line is rendered.
 And more importantly,
 each rendering directly generates a sonic outcome.

Perhaps this interpretation is a bit too showy for my tastes,
 we can hear the printer audibly casting the paper onto the floor after finishing each page,
 like a petulant pianist,
 an act which strikes me as slightly too theatrical for a performance so restrained.

But I guess I have to forgive it,
 and like much of this recording,
 just submit to the creativity of a machine performing an action that was never designed to be sonically aestheticized.
 Submit myself to a non-anthropocentric aesthetic.

With a recording so uninterested in a human response to it,
 a logical question is:
 what am I,
 as a listener,
 meant to get from it?
 In answer,
 I submit that old joke about a music obsessive and record collector,
 who is asked whether he likes Captain Beefheart's "Trout Mask Replica",
 a copy of which he has just been given,
 and an album which is widely regarded as one of the best rock albums ever made.
 Their answer:
 "Not yet."

Fig. Conc.6 Liner notes to the album *MG3250 Plays Cornelis Cardew's "Treatise"*

Non-Divinatory Bibliography for Chapter 4 and Conclusion

- Abbott, H. Porter. 2008. *The Cambridge Introduction to Narrative*. 2nd ed. Cambridge: Cambridge University Press.
- Abler, William. 1989. "On the particulate principle of self-diversifying systems." *Journal of Social and Biological Structures* 12:1–13.
- Adams, Jon. 2008. "Plot Taxonomies and Intentionality." *Philosophy and Literature* 32:102–118.
- Allen, James. 2007. "Aristotle on the Disciplines of Argument: Rhetoric, Dialectic, Analytic." *Rhetorica* 25 (1): 87–109.
- Andrejevic, Mark. 2013. *Infoglut*. London: Routledge.
- Ankowski, Amber A., Haley A. Vlach, and Catherine M. Sandhofer. 2013. "Comparison Versus Contrast: Task Specifics Affect Category Acquisition." *Infant and Child Development* 22:1–23.
- Applebee, Arthur N. 1978. *The Child's Concept of Story*. Chicago: University of Chicago.
- Armstrong, Michael. 2007. *Children Writing Stories*. London: McGraw-Hill Education.
- Ayton, Peter, and Ilan Fischer. 2004. "The hot hand fallacy and the gambler's fallacy: Two faces of subjective randomness?" *Memory and Cognition* 32 (8): 1369–1378.
- Baldini, Andrea. 2014. "Historical Formalism in Music: Towards a Philosophical Theory of Musical Form." *Contemporary Aesthetics* 12.
- Barlow, Clarence. 2012. "Music Derived from Other Sources." <http://clarlow.org/wp-content/uploads/2016/10/Music-Derived-from-Other-Sources.pdf>.
- Beard, James K. 2017. "James K Beard's Complimentary Files." <http://jameskbeard.com/jameskbeard/Files.html#CostasArrays>.
- Beghin, Tom, and Sander M Goldberg. 2007. *Haydn and the performance of rhetoric*. Chicago: University of Chicago Press.
- Beit-Hallahmi, Benjamin, and Michael Argyle. 1975. "God as a father-projection: the theory and the evidence." *Br. J. med. Psychol.* 48:71–75.
- Bennett, Charles H. 2007. "On Random and Hard-to-Describe Numbers." In *Randomness and Complexity from Leibniz to Chaitin*, ed. by Cristian S Calude, 3–12. Singapore: World Scientific.
- Berofsky, Bernard. 1966. *Free Will and Determinism*. New York: Harper / Row.
- Black, John, Niger Hashimzade, and Gareth Myles. 2017. *A Dictionary of Economics*. Oxford: Oxford University Press.
- Blair, J. Anthony. 2012. "Rhetoric, Dialectic, and Logic as Related to Argument." *Philosophy and Rhetoric* 45 (2): 148–164.
- Bonds, Mark Evan. 2010. "The Spatial Representation of Musical Form." *The Journal of Musicology* 27 (3): 265–303.
- Booker, Christopher. 2004. *The Seven Basic Plots*. 2004: Continuum.
- Brooks, Peter. 1984. *Reading for the Plot*. Cambridge, MA: Harvard University Press.
- Bunyan, John. 2003. *The Pilgrim's Progress*. Ed. by W. R. Owens. Oxford: Oxford University Press.

- Cambria, Erik. 2016. "Affective Computing and Sentiment Analysis." *IEEE Intelligent Systems* 31 (2): 102–107.
- Caplin, William E. 1998. *Classical Form*. London: Oxford University Press.
- Cervantes Saavedra, Miguel de. 2004. "Don Quixote." <http://www.gutenberg.org/cache/epub/996/pg996.html>.
- Chaitin, Gregory. 2002. "Paradoxes of Randomness and the Limitations of Mathematical Reasoning." *Complexity* 7 (5): 14–21.
- Chaitin, Gregory J. 1998. *The Limits of Mathematics*. London: Springer.
- Charlton, Benjamin D. 2014. "Menstrual cycle phase alters women's sexual preferences for composers of more complex music." *Proceedings of the Royal Society B* 281 (20140403).
- Cockcroft, Robert, and Susan Cockcroft. 2014. *Persuading People: An Introduction to Rhetoric*. Basingstoke: Palgrave Macmillan.
- Cole, William. 1969. *Form in Music*. London: The Associated Board of the Royal Schools.
- Collins, Nick. 2009. "Musical Form and Algorithmic Composition." *Contemporary Music Review* 28 (1): 103–114.
- Cone, Edward T. 1968. *Musical Form and Musical Performance*. London: W. W. Norton.
- Cook, Roy T. 2009. *A Dictionary of Philosophical Logic*. Edinburgh: Edinburgh University Press.
- Cowan, Nelson. 2000. "The magical number 4 in short-term memory: A reconsideration of mental storage capacity." *Behavioral and Brain Sciences* 24:87–114.
- Deleuze, Gilles, and Félix Guattari. 2004. *A Thousand Plateaus*. Continuum Books.
- Deliège, Irène. 1989. "A perceptual approach to contemporary musical forms." *Contemporary Music Review* 4 (1): 213–230.
- Dworkin, Gerald. 1970. *Determinism, Free Will and Moral Responsibility*. Englewood Cliffs, NJ: Prentice-Hall.
- Eagleman, David M. 2008. "Human time perception and its illusions." *Current Opinion on Neurobiology* 18:131–169.
- Elias, Norbert. 1997. *The Civilizing Process*. Oxford: Blackwell.
- Farmer, George D., Paul A. Warren, and Ulrike Hahn. 2017. "Who 'Believes' in the Gambler's Fallacy and Why?" *Experimental Psychology: General* 146 (1): 63–76.
- Felluga, Dino. 2015. "General Introduction to Narratology." Introductory Guide to Critical Theory. <https://www.cla.purdue.edu/english/theory/narratology/modules/greimassquare.html>.
- Ferguson, Niels, and Bruce Schneier. 2003. *Practical Cryptography*. Indianapolis: Wiley Publishing.
- Féron, François-Xavier. 2014. "Could the endless progressions in James Tenney's music be viewed as sonic koans?" In *Proceedings ICMC/SMC/2014*.
- Fitch, W. Tecumseh, and Mauricio D. Martins. 2014. "Hierarchical processing in music, language, and action: Lashley revisited." *Annals of the New York Academy of Sciences* 1316:87–104.
- Fitterman, Robert. 2014. *No, Wait. Yep. Definitely Still Hate Myself*. New York: Ugly Duckling Presse.
- Folding-Ideas. 2016. "The Art of Editing and Suicide Squad." <https://www.youtube.com/watch?v=mDclQowcE9I>.
- Fordham, Frieda. 1966. *An Introduction to Jung's Psychology*. Harmondsworth: Penguin.
- Forte, Allen. 1973. *The Structure of Atonal Music*. New Haven: Yale University Press.
- Freud, Sigmund. 2009. "Jenseits des Lustprinzips." <http://www.gutenberg.org/files/28220/28220-h/28220-h.htm>.
- . 2005. *The Essentials of Psycho-analysis*. Ed. by Anna Freud. London: Vintage Books.
- Furnham, Adrian. 1990. *The Protestant Work Ethic*. London: Routledge.
- Giancoli, Douglas C. 1980. *Physics: Principles with Applications*. 3rd ed. London: Prentice-Hall International.

- Glover, Richard. 2010. "Seventh Inversions." <http://eprints.hud.ac.uk/13261/>.
- Gorea, Andrei. 2011. "Ticks per thought or thoughts per tick? A selective review of time perception with hints on future research." *Journal of Physiology - Paris* 105:153–163.
- Granot, Roni Y., and Nori Jacoby. 2011a. "Musically Puzzling I: Sensitivity to overall structure in the sonata form?" *Musicae Scientiae* 15 (3): 365–386.
- . 2011b. "Musically puzzling II: Sensitivity to overall structure in a Haydn E-minor sonata." *Musicae Scientiae* 16 (1): 67–80.
- Greenbaum, Matthew. 2008. "Debussy, Wolpe and Dialectical Form." *Contemporary Music Review* 27 (2/3): 343–359.
- Grünwald, Peter D., and Paul M. B. Vitányi. 2008. "Algorithmic Information Theory." *CoRR* abs/0809.2754. <http://arxiv.org/abs/0809.2754>.
- Guessford, Jesse James. 2004. "The Compositional Procedures Used in John Cage's "Six Short Inventions", "First Construction (In Metal)" and "Spontaneous Earth"." PhD thesis, University of Illinois at Urbana-Champaign.
- Haneke, Michael. 1997. *Funny Games*.
- Hanninen, Dora A. 2004. "Feldman, Analysis, Experience." *twentieth-century music* 1 (2): 225–251.
- Heimbecker, Sara. 2008. "Gesamtkunstwerk, and Utopia." *American Music* 26 (4): 474–498.
- Hennig, Holger, et al. 2011. "The Nature and Perception of Fluctuations in Human Musical Rhythms." *PLoS ONE* 6 (10).
- Hoffman, Elizabeth. 2012. "'I'-Tunes: Multiple Subjectivities and Narrative Method in Computer Music." *Computer Music Journal* 36 (4): 40–58.
- Howe, Daniel C., Helen Nissenbaum, and Vincent Toubiana. n.d. "TrackMeNot." <https://cs.nyu.edu/trackmenot/>.
- Hunter, David J., and Paul T. von Hippel. 2003. "How Rare Is Symmetry in Musical 12-Tone Rows?" *The American Mathematical Monthly* 110 (2): 124–132.
- Husserl, Edmund. 1999. "A Phenomenology of the Consciousness of Internal Time." In *The Essential Husserl*, ed. by Donn Welton, 186–220. Indiana: Indiana University Press.
- Iddon, Martin. 2013. *New Music at Darmstadt*. Cambridge: Cambridge University Press.
- Johnson, Tom. 1996. *Self-Similar Melodies*. Paris: Editions 75.
- Katz, Jonathan, and Yehuda Lindell. 2015. *Introduction to Modern Cryptography*. London: CRC Press.
- Kaufman, Charlie. 2008. *Synecdoche, New York*.
- Kim-Cohen, Seth. 2010. "Forever Got Shorter (from a tshirt of the same name)." [http://www.kim-cohen.com/Assets/Texts/Kim-Cohen_Forever%20Got%20Shorter%20\(2008\).pdf](http://www.kim-cohen.com/Assets/Texts/Kim-Cohen_Forever%20Got%20Shorter%20(2008).pdf).
- Knuth, Donald. 1982. "Concept of a Meta-Font." *Visible Language* 16 (1): 3–27.
- Kohs, Ellis B. 1976. *Musical Form*. Atlanta: Houghton Mifflin.
- komponist. 2007. "Musical Form." <http://musictheoryblog.blogspot.co.uk/2007/02/musical-form.html>.
- Kramer, Jonathan D. 1978. "Moment Form in Twentieth Century Music." *The Musical Quarterly* 64 (2): 177–194.
- Krouglov, Alexei N. 2011. "Kiesewetter's Logic in Tolstoy's Death of Ivan Il'ich." *Russian Studies in Philosophy* 50 (2): 58–69.
- Lalitte, P., and E. Bigand. 2006. "Music in the moment? Revisiting the effect of large scale structures." *Perceptual and Motor Skills* 103:811–828.
- Law, Jonathan, and Richard Rennie. 2015. *A Dictionary of Physics*. 7th ed. Oxford: Oxford University Press.
- Lely, John, and James Saunders. 2008. *Word Events*. London: Continuum.
- Levinson, Jerrold. 1997. *Music in the Moment*. Ithaca: Cornell University Press.

- Li, Ming, and Paul Vitányi. 2008. *An Introduction to Kolmogorov Complexity and Its Applications*. 3rd ed. London: Springer.
- Mack, Peter. 2007. "Rhetoric and Dialectic in the Renaissance." *Bulletin of the Institute of Classical Studies* 50 (S96): 91–103.
- Macpherson, Stewart. 1930. *Form in Music*. London: Joseph Williams.
- Malancharuvil, Joseph M. 2004. "Projection, Introjection, and Projective Identification: A Reformulation." *The American Journal of Psychoanalysis* 64 (4): 375–382.
- Marchant, Alicia. 2014. "Narratives of Death and Emotional Affect in Late Medieval Chronicles." *Parergon* 31 (2): 81–98.
- Marx, A. B. 1997. *Musical Form in the Age of Beethoven*. Cambridge: Cambridge University Press.
- Matossian, Nouritza. 1986. *Xenakis*. London: Kahn / Averill.
- McKean, John A. Hansmann. 2011. "Compositional Process and Notational Implications in Ligeti's 'Continuum für Cembalo.'" https://www.academia.edu/5059924/Compositional_Process_and_Notational_Implications_in_Ligeti_s_Continuum_f%C3%BCr_Cembalo.
- Mertens, Wim. 2004. *American Minimal Music*. Amersham: Halstan / Co.
- Meyer-Eppler, Wener. 1968. "Musical Communication as a Problem of Information Theory." *Die Reihe* 8:7–10.
- Morris, R. O. 1935. *The Structure of Music*. London: Oxford University Press.
- MTVU. 2011. "Writing Advice from Matt Stone & Trey Parker @ NYU | MTVU's 'Stand In'." <https://www.youtube.com/watch?v=vGUNqq3jVLg>.
- Neuhaus, Christiane. 2013. "Processing musical form: Behavioural and neurological approaches." *Musicae Scientiae* 17 (1): 109–127.
- Nolan, Christopher. 2008. *The Dark Knight*.
- Pinker, Steven. 2011. *The Better Angels of Our Nature*. London: Allen Lane.
- Pinto, Giuliana, Christian Tarchi, and Lucia Bigozzi. 2016. "Development in narrative competences from oral to written stories in five- to seven-year-old children." *Early Childhood Research Quarterly* 36:1–10.
- Pocknee, David. 2015a. "An Experimodern Coda to Human Sexuality." http://cerenem.ricercata.org/articles/human_sexuality/page01.html.
- . 2009. "Analysis of 'Quartetto No 4' by Giacinto Scelsi." <http://davidpocknee.ricercata.org/writing/scelsi.pdf>.
- . 2013. "Virtuosity, Flow, And Re-Notating Modernism." <http://davidpocknee.ricercata.org/writing/virtuosityzax.pdf>.
- . 2015b. "What Some Dead White Guy Did: A Statistical Topology of Keyboard Usage in Beethoven's Keyboard Sonatas." <http://cerenem.ricercata.org/articles/beethoven/page01.html>.
- Polansky, Larry. 1996. "Morphological Metrics." *Journal of New Music Research* 25:289–368.
- Reagan, Andrew J., et al. 2016. "The emotional arcs of stories are dominated by six basic shapes." *CoRR* abs/1606.07772. <http://arxiv.org/abs/1606.07772>.
- Roads, Curtis. 2004. *Microsound*. Cambridge, MA: MIT Press.
- Robinson, Jenefer. 2007. "Can Music Function as a Metaphor of Emotional Life?" In *Philosophers on Music*, ed. by Kathleen Stock, 149–177. Oxford: Oxford University Press.
- Roe, John. 1997. *Elementary Geometry*. Oxford: Oxford University Press.
- Rohmann, Chris. 2002. *The Dictionary of Important Ideas and Thinkers*. London: Arrow Books.
- Rohrmeier, Martin, et al. 2015. "Principles of structure building in music, language and animal song." *Philosophical Transactions B* 370 (20140097): 1–15.
- Rudder, Christian. 2014. *Dataclysm*. London: 4th Estate.

- Saaty, T. L., and M. S. Ozdemir. 2003. "Why the Magic Number Seven Plus or Minus Two." *Mathematical and Computer Modelling* 38:233–244.
- Satie, Erik. 1969. *Vexations*. London: Max Eschig.
- Schellinx, Harold. 2014. "The Eerie Symmetry of a Perfect Ping." Visited on 12/24/2015. http://www.harsmedia.com/SoundBlog/Archief/00814.php#ref_2.
- Schindler, Samuel. 2014. "Novelty, coherence, and Mendeleev's periodic table." *Studies in History and Philosophy of Science* 45:62–69.
- Scholes, Percy A. 1976. *The Oxford Companion to Music*. 10th ed. Ed. by John Owen Ward. London: Oxford University Press.
- Silva, Susana, et al. 2014. "Musical phrase boundaries, wrap-up and the closure positive shift." *Brain Research* 1585:99–107.
- Silver, Nate. 2012. *The Signal and the Noise: The Art and Science of Prediction*. London: Penguin.
- Sophocles. 1952. "Oedipus the King." In *Great Books of the Western World: 5 Aeschylus Sophocles Eurides Aristophanes*, ed. by Robert Maynard Hutchins, 52–69. London: William Benton.
- Stuart-Hamilton, Ian. 2007. *Dictionary of Psychological Testing, Assessment and Treatment*. London: Jessica Kingsley Publishers.
- Taatgen, Niels A., Hedderik van Rijn, and John Anderson. 2007. "An Integrated Theory of Prospective Time Interval Estimation: The Role of Cognition, Attention, and Learning." *Psychological Review* 114 (3): 577–598.
- Tenney, James. 2015. *From Scratch: Writings in Music Theory*. University of Illinois Press.
- . 1984. *SOUNDINGS 13: The Music Of James Tenney*. Ed. by Peter Garland. Santa Fe: Soundings Press.
- Tenney, James, and Larry Polansky. 1980. "Temporal Gestalt Perception in Music." *Journal of Music Theory* 24 (2): 205–241.
- Tovey, Donald. 1967. *The Forms of Music*. London: Oxford University Press.
- Upton, Graham, and Ian Cook. 2016. "Bayesian Inference." In *A Dictionary of Statistics*. Oxford University Press.
- White, Hayden. 1987. *The Content of Form*. Baltimore: Johns Hopkins University Press.
- Whittall, Arnold. 2001. "Form." In *The New Grove Dictionary of Music and Musicians*, 2nd ed., ed. by Stanley Sadie, 9:92–94. New York: Grove.
- Wikipedia. n.d. "The Seven Basic Plots." https://en.wikipedia.org/wiki/The_Seven_Basic_Plots.
- Wingfield, Paul. 2008. "Beyond 'Norms and Deformations': Towards a Theory of Sonata Form as Reception History." *Music Analysis* 27 (1): 137–177.
- Winter, Michael. 2014. "On minimal change musical morphologies." *Proceedings of the 2014 International Congress on Music and Mathematics*. <http://www.unboundedpress.org/>.
- Wuorinen, Charles. 1979. *Simple Composition*. New York: Longman.
- Zauberman, Gal, et al. 2010. "1995 Feels So Close Yet So Far: The Effect of Event Markers on Subjective Feelings of Elapsed Time." *Psychological Science* 21 (1): 133–139.
- Zhang, Jingjing, et al. 2016. "Perception of hierarchical boundaries in music and its modulation by expertise." *Neuropsychologia* 91:490–498.

Quantized Divinatory Bibliography for Chapter 4 and Conclusion

- Albon, Deborah. 2012. "Postmodern and post-structuralist perspectives on early childhood education." In *Extending Professional Practice in the Early Years*, ed. by Linda Miller, Rose Drury, and Carrie Cable, 156–168. London: The Open University / SAGE.
- Clark, Alison. 2012. "Ways of seeing: using the Mosaic approach to listen to children's perspectives." In *Extending Professional Practice in the Early Years*, ed. by Linda Miller, Rose Drury, and Carrie Cable, 11–28. London: The Open University / SAGE.
- Goodman, David S. G. 1981. *Beijing Street Voices: The Poetry and Politics of China's Democracy Movement*. London: Marion Boyars.
- Hedegaard, Mariane. 2012. "A cultural-historical theory of children's development." In *Extending Professional Practice in the Early Years*, ed. by Linda Miller, Rose Drury, and Carrie Cable, 193–210. London: The Open University / SAGE.
- Hesseling, Pjotr. 1982. *Effective Organization Research for Development*. Oxford: Pergamon Press.
- Hock, Hans Henrich. 1991. *Principles of Historical Linguistics*. Berlin: Mouton de Gruyter.
- Hubbard, L. Ron. 1999. *Scientology - The Fundamentals of Thought*. Copenhagen: NEW ERA Publications, International ApS.
- Jones, Liz, et al. 2012. "'Improper' children." In *Extending Professional Practice in the Early Years*, ed. by Linda Miller, Rose Drury, and Carrie Cable, 173–183. London: The Open University / SAGE.
- Kay, Elizabeth, and David Locker. 1997. *Effectiveness of oral health promotion: a review*. London: Health Education Authority.
- Kay, Janet. 2007. *Behavioural, Emotional and Social Difficulties*. London: Continuum.
- Marsh, Ian, et al. 2006. *Theories of Crime*. Abingdon: Routledge.
- McKee, Robert. 1999. *Story*. York: Methuen.
- Miller, Linda, Rose Drury, and Carrie Cable, eds. 2012. *Extending Professional Practice in the Early Years*. London: Open University / Sage.
- Moore, Timothy E., ed. 1973. *Cognitive Development and The Acquisition of Language*.
- Riordan, Michael, and Lillian Hoddeson. 1997. *Crystal Fire: The invention of the transistor and the birth of the information age*. London: W. W. Norton / Company.
- Syme, Gabrielle. 2003. *Dual Relationships in Counselling and Psychotherapy*. London: SAGE.
- Zwart, H. Sinclair-de. 1973. "Language Acquisition and Cognitive Development." In *Cognitive Development and the Acquisition of Language*, ed. by Timothy E. Moore, 9–26. London: Academic Press.

Unquantized Divinatory Bibliography for Chapter 4 and Conclusion

- Altarriba, Jeanette. 2012. "Emotion and Mood: Over 120 Years of Contemplation and Exploration in "The American Journal of Psychology"." *American Journal of Psychology* 125 (4): 409–422.
- Berghaus, Günter. 2001. "The Futurist Banquet: Nouvelle Cuisine or Performance Art?" *New Theatre Quarterly* XVII (1): 3–17.
- Bridger, Alexander John. 2013. "Psychogeography and feminist methodology." *Feminism and Psychology* 23 (3): 285–298.
- Cha, Jeongwan, Geunbae Lee, and Jonghyeok Lee. 2002. "Korean Combinatory Categorical Grammar." *Computers and the Humanities* 36:431–453.
- Cook, Peter. 1987. "Determinism and Probability in Physics." *The Aristotelian Society* LXI.
- Delgado, Maria M. 2007. "Composing for the Stage: The Music Theatre of Carles Santos." *Contemporary Theatre Review* 17 (3): 278–300.
- Diengott, Nilli. 2008. "Structuralist narratology redux? Kafalenos' 'Narrative Causalities'." *Journal of Literary Semantics* 37 (2): 169–178.
- Féral, Josette. 2008. "Introduction: Towards a Genetic Study of Performance - Take 2." *Theatre Research International* 33 (1): 223–233.
- Garipzanov, Ildar H. 2006. "Metamorphoses of the early medieval signum of a ruler in the Carolingian world." *Early Medieval Europe* 14 (4): 419–464.
- Geis, Gilbert. 2000. "On the absence of self-control as the basis for a general theory of crime: A critique." *Theoretical Criminology* 4 (1): 35–53.
- Giorgi, Liana, and Catherine Marsh. 1990. "The Protestant Work ethic as a Cultural Phenomenon." *European Journal of Social Psychology* 20:499–517.
- Graves, Heather, Shahin Moghaddasi, and Azirah Hashim. 2013. "Mathematics is the method: Exploring the macro-organizational structure of research articles in mathematics." *Discourse Studies* 15 (4): 421–438.
- Gwilliam, Tassie. 1996. "Female Fraud: Counterfeit Maidenheads in the Eighteenth Century." *Journal of the History of Sexuality* 6 (4): 518–548.
- Haber, Ralph Norman, and Lyn R. Haber. 1981. "The shape of a word can specify its meaning." *Reading Research Quarterly* XVI (3): 334–345.
- Hartman, Elwood. 1973. "Théophile Gautier on Progress in the Arts." *Studies in Romanticism* 12 (2): 530–550.
- Hauser, Marc D. 2000. "A Primate Dictionary? Decoding the Function and Meaning of Another Species' Vocalizations." *Cognitive Science* 24 (3): 445–475.
- Hayot, Eric. 2014. "Academic Writing, I Love You, Really, I Do." *Critical Inquiry* 41 (1): 53–77.
- Hayot, Eric, and Edward Wesp. 2004. "Style: Strategy and Mimesis in Ergodic Literature." *Comparative Literature Studies* 41 (3): 404–423.

- Hensel, Paul R., and Paul F. Diehl. 1994. "Testing empirical propositions about shatterbelts, 1945-76." *Political Geography* 13 (1): 33-51.
- Italia, Paul G. 1990. "Under the Rules of Time: Story and Plot in E. M. Forster's 'A Passage to India'." *English Language Notes* XXVII (3): 58-62.
- Koehler, Martha J. 1994. "Epistolary Closure and Triangular Return in Richardson's 'Clarissa'." *Journal of Narrative Technique* 24 (3): 153-172.
- Leach, Elizabeth Eva. 2010. "Music and Verbal Meaning: Machaut's Polytextual Songs." *Speculum* 85 (3): 567-591.
- Massaro, Dominic W., and Michael M. Cohen. 1995. "Continuous versus discrete information processing in pattern recognition." *Acta Psychologica* 90:193-209.
- Medero, Dana. 1998. "The Sieve and the Rainbow Serpent: Bleeding 'Gravity's Rainbow'." *Journal of Narrative Technique* 28 (2): 186-213.
- Miall, David S. 2004. "Episode structures in literary narratives." *Journal of Literary Semantics* 33 (2): 111-129.
- Nicholson, Catherine. 2010. "Othello and the Geography of Persuasion." *English Literary Renaissance* 40 (1): 56-87.
- Packard, Stephan. 2008. "Two-dimensional narrative velocity." *Journal of Literary Semantics* 37 (1): 55-67.
- Pelias, Ronald J. 2005. "Performative Writing as Scholarship: An Apology, an Argument, an Anecdote." *Cultural Studies <-> Critical Methodologies* 5 (4): 415-424.
- Povinelli, Daniel J., Jesse M. Bering, and Steve Giambrone. 2000. "Towards a Science of Other Minds: Escaping the Argument by Analogy." *Cognitive Science* 24 (3): 509-541.
- Rabin, Claire. 1983. "Towards the Use and Development of Games for Social Work Practice." *British Journal of Social Work* 13:175-196.
- Richardson, Angeliq. 1999/2000. "The Eugenization of Love: Sarah Grand and the Morality of Genealogy." *Victorian Studies* 42 (2): 227-255.
- Rolland, Pierre-Yves. 2001. "Introduction: Pattern Processing in Music Analysis and Creation." *Computers and the Humanities* 35:3-8.
- Rotton, James, and Ellen G. Cohn. 2000. "Violence Is a Curvilinear Function of Temperature in Dallas: A Replication." *Journal of Personality and Social Psychology* 78 (6): 1074-1081.
- Ryf, Robert S. 1977. "B. S. Johnson and the Frontiers of Fiction." *Critique: Studies in Modern Fiction* XIX (1): 58-74.
- Sánchez-Eppler, Karen. 1988. "Decomposing: Wordsworth's Poetry of Epitaph and English Burial Reform." *Nineteenth-Century Literature* 42 (4): 415-431.
- Shorten, Richard. 2013. "How to study ideas in poitics and 'influence': a typology." *Contermprary Politics* 19 (4): 361-378.
- Sim, Stuart. 1987. "'Vertuous Mediocrity' and 'Fanatick Conventicle': Pilgrimage Styles in John Bunyan and Bishop Simon Patrick." *English Studies* 68 (4): 316-324.
- Simonton, Dean Keith. 1980. "Thematic fame and melodic originality in classical music: A multivariate computer-content analysis." *Journal of Personality* 48 (2): 206-219.
- Smith, S. A. 2008. "Introduction." *Past and Present: Supplement 3*: 7-55.
- Stein-Wilkeshuis, Martina. 1984. "Thieves in Medieval Icelandic Laws." *Criminal Justice History* V:1-21.
- Stevenson, Walter. 1995. "The Rise of Eunuchs in Greco-Roman Antiquity." *Journal of the History of Sexuality* 5 (4): 495-511.
- Stolberg, Michael. 2000. "Self-pollution, Moral Reform, and the Venereal Trade: Notes on the Sources and Historical Context of 'Onania' (1716)." *Journal of the History of Sexuality* 9 (1-2): 37-61.
- Summers, Jeffery J., et al. 1993. "Production of Polyrythms." *Journal of Experimental Psychology: Human Perception and Performance* 19 (2): 416-428.

- Sutton, Clive. 1994. "'Nullius in verba' and 'nihil in verbis': public understanding of the role of language in science." *British Journal for the History Science* 27:55–64.
- White, R. Andrew. 2006. "Stanislavsky and Ramacharaka: The Influence of Yoga and Turn-of-the-Century Occultism on the System." *Theatre Survey* 47 (1): 73–92.
- Wielgosz, Anne-Kathrin. 1995. "Displacement in Raymond Federman's 'Double or Nothing' or: 'noodles and paper coincide'." *Journal of Narrative Technique* 25 (1): 91–107.

Appendices

Appendix A

Optimal Quantization Methods

How might three pulses one second apart be represented in traditional Western European rhythmic notation?

The distance between each attack can be referred to as an inter-onset interval (or IOI). The inter-onset interval between each pulse is 1 second (or 1000 milliseconds). A notation of this sound will be conceived of as optimally quantized where the computed IOI between attacks in the notation and attacks in the recording are the same i.e. $d(x, y) = 0$.

Optimal Quantization by Metre

The simplest way to create optimally quantized musical notation is a process we could call *Optimal Quantization by Metre*. This involves imposing a metre onto a set of equidistant pulses such that they coincide with the highest-level metric stresses.

If all inter-onset intervals are the same (equidistant), this can be calculated through the following formula where i = inter-onset interval in seconds and t = tempo (bpm):

$$t = \frac{60}{i}$$

Therefore, a possible optimally quantized tempo for three pulses with inter-onset intervals of 1 second (1000ms) would be calculated using the following equation, and which results in the notation in Figure A.1:

$$\frac{60}{1.0} = 60bpm$$

A time signature is defined by two elements: the numerator (top number) and denominator (bottom number). *Optimal Quantization by Metre* always quantizes the input to the denominator, where 2 = half-note, 4 = quarter-note, 8 = eighth-note, 16 = sixteenth-note etc. . . . The numerator can then be set to any arbitrary length, although in the type of optimal quantization we are doing here, it will always be the number of onsets/pulses i.e. 3.

By extending this equation to include the denominator of the time signature as a parameter, *optimal quantization by metre* can be calculated for metres other than those using a quarter-note as the denominator. In the equation below, TS_d = time signature denominator.

$$t = \frac{60}{i} \times \frac{4}{TS_d}$$



Figure A.1: Simple metric optimal quantization of three pulses one second apart using a 60bpm tempo

By enumerating all possible integers which are powers of 2, we can list all possible *optimal quantizations by metre* for rational time signatures. When we use integers which are not powers of 2, we can list all possible irrational time signatures.

The psychomusicologist Justin London, in his book on rhythm *Hearing In Time*, points out that humans can only reliably entrain (synchronize) to rhythms higher than 30 and lower than 150 bpm (London 2012), therefore, in all the examples that occur in this section, only tempi which fall within this range will be used.

Figures A.2 and A.3 show the notations of quantizations for rational and irrational quantizations of three pulses 1 second apart, within 30-150bpm:

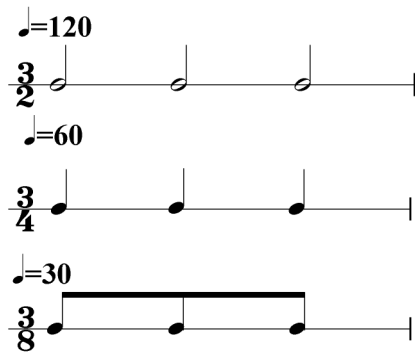

Figure A.2: All possible optimal quantizations of three pulses one second apart, using rational metres lying between 30 - 150 bpm

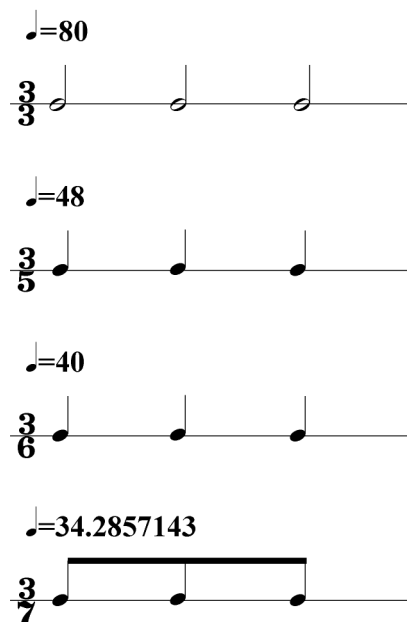

Figure A.3: All possible optimal quantizations of three pulses one second apart, using irrational metres lying between 30 - 150 bpm

Optimal Quantization by Rhythm

Another procedure that can be used alongside the method of *optimal quantization by metre*, outlined above, is *optimal quantization by rhythm*.

Whereas *optimal quantization by metre* uses the tempo and time signature denominator as a way of quantizing the material, *optimal quantization by rhythm* uses rhythm to accomplish the same aim.

This procedure involves the choice of a notational duration that is not based on a power of 2. e.g. a duration that is not a quarter-note, eighth-note, half-note etc. but instead, something like one-and-a-half quarter-notes. If the notational duration is represented in a form such that quarter-note = 1, eighth-note = 0.5 etc. then the following equation can be used to calculate the tempo for any optimal quantization.

The Variables:

- t = tempo (bpm)
- i = inter-onset interval (s)
- TS^n = time signature numerator ($TS^n \in \mathbb{Z}$)
- TS_d = time signature denominator ($TS_d \in \mathbb{Z}$)

- m = the notated duration that the metronome marking is in reference to (quarter-note = 4, eighth-note = 8 etc.)
- l = note length (in beats) (this is how many beats the note lasts, where one quarter-note = 1, one eighth-note = 0.5 etc.)

First, the numerator of the time signature is calculated: Then, the tempo can be calculated:

$$TS^n = l \times \frac{TS_d}{4} \qquad t = \frac{60}{i} \times \frac{m}{4} \times l$$

In practice, suppose that we wished to re-quantize the three pulses one second apart using a time signature denominator of a 16th-note ($TS_d = 16$), with each pulse being re-notated as a dotted-eighth-note ($l = 0.75$), with a tempo marking that is in relationship to quarter-notes ($a = 4$):

First, the numerator is calculated:

$$TS^n = 0.75 \times \frac{16}{4} = 9$$

Giving a time signature of 9/16. Then, the tempo can be calculated:

$$t = \frac{60}{1.0} \times \frac{4}{4} \times 0.75 = 45$$

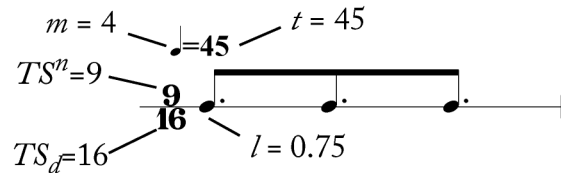

Figure A.4: Optimal quantization of three pulses one second apart where $TS_d = 16$, $l = 0.75$ and $m = 4$.

Giving the notation shown in A.4.

These two new equations can also be used to generate all the examples quantized by tempo in the previous section.

So why bother defining these things mathematically? Well, by swapping out some of the variables in the equation, it is possible to algorithmically generate all possible rational and irrational *optimal quantizations by rhythm* of the three pulses, within constraints. Here I will only deal with rational metres for the sake of brevity but the equation can be used to easily generate quantizations using irrational tempi.

Results where $n_{SIG} \notin \mathbb{Z}$ were discarded, as these would give invalid time signatures e.g. $\frac{4.3}{4}$. Results are shown in Figure A.5, with the following values used to generate them: $TS_d = \{2, 4, 8, 16\}$ and $l = \{0.25, 0.5, 0.75, 1.0, 1.25, 1.5, 1.75, 2.0\}$, $i = 1, p = 3, m = 4$.

Optimal Quantization by Tuplet

A third layer of quantization can be applied to *optimal quantization by rhythm* and *optimal quantization by metre: optimal quantization by tuplet*. This involves applying a further tuplet structure to the tempi and rhythmic quantization.

The following variables are used in *optimal quantization by tuplet*:

- i = Inter-Onset Interval of pulses
- p = number of pulses in the bar ($p \in \mathbb{Z}$)
- t = Tempo
- m = The notated duration that the metronome marking is in reference to

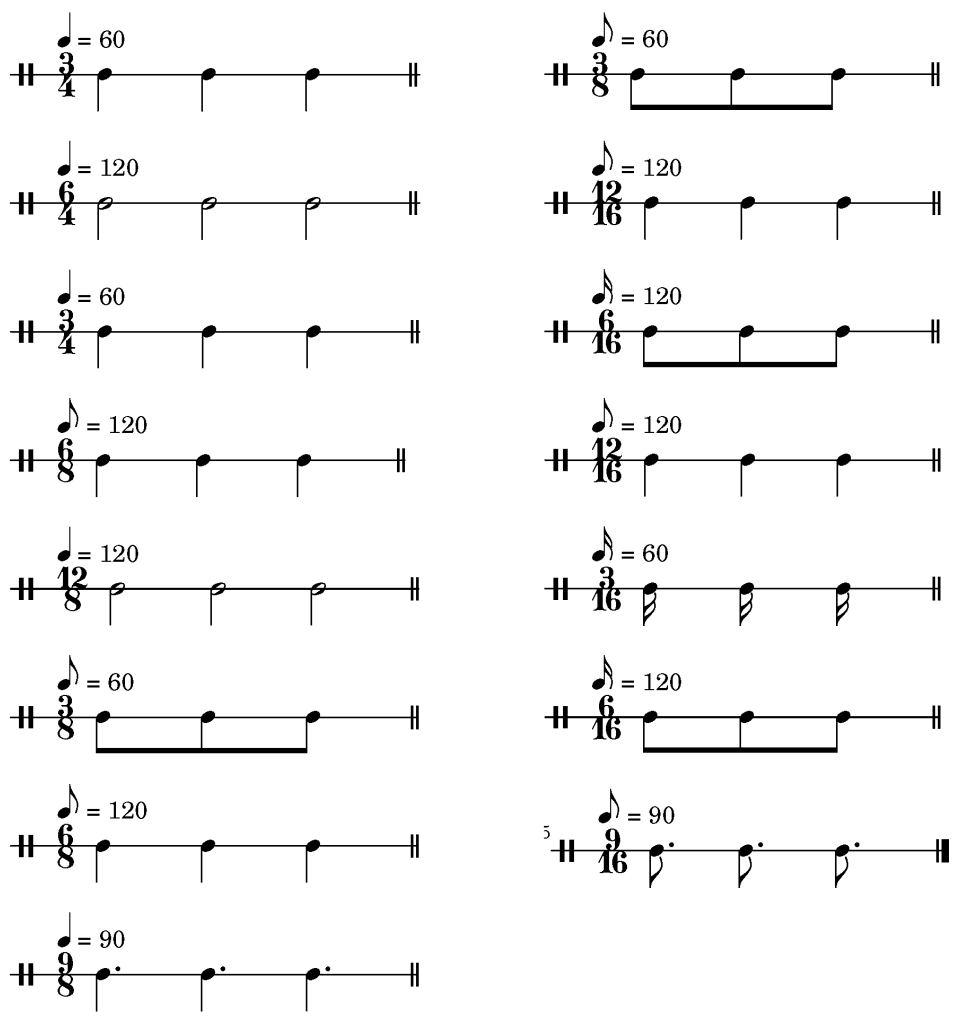

Figure A.5: Optimal quantization by metre of three pulses one second apart.

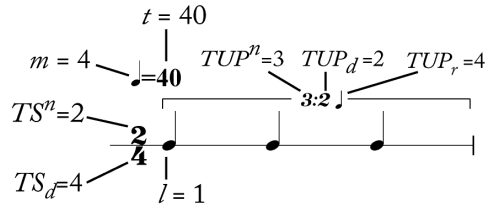

Figure A.6: Result of quantization procedure.

- l = Notational length of pulses
- TS^n = Time signature numerator
- TS_d = Time signature denominator
- TUP^n = Tuplet numerator ($TUP^n \in \mathbb{Z}$)
- TUP_d = Tuplet denominator ($TUP^d \in \mathbb{Z}$)
- TUP_r = Length of note used in tuplet ratios (quarter-note = 4, eighth-note = 8 etc.)

A simple calculation for ascertaining the tempo of a bar, given the numerator and denominator of a tuplet and its reference note is:

$$t = \frac{60}{i} \times \frac{TUP_d}{TUP^n} \times \frac{4}{TUP_r}$$

So, given an inter-onset interval of 1 second and a tuplet ratio of 3:2 quarter-notes, you would need a tempo of:

$$t = \frac{60}{1} \times \frac{2}{3} \times \frac{4}{4} = 40bpm$$

This equation can be combined with that used for *quantization by rhythm* to produce an equation that can be used for any type of quantization, be it metre, rhythm or tuplet:

The numerator of the time signature:

$$TS^n = \frac{TS_d}{TUP_r} \times TUP_d$$

The numerator of the tuplet:

$$TUP^n = l \times p \times \frac{TUP_r}{4}$$

Tempo (this will always be in reference to the denominator of the time signature):

$$t = \frac{TS^n}{i \times p} \times 60$$

To generate an optimal metric quantization which has no tuplets, make it so that $TUP_d = TUP^n$.

Example

We are writing a piece of music at quarter-note = 40 ($m = 4$, $t = 40$). We want to quantize 3 pulses ($p = 3$), 1 second apart ($i = 1$) within one bar at this tempo. We want the length of each pulse in the notation to be a dotted-quarter-note ($l = 1.5$).

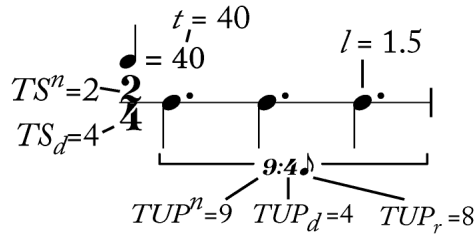

Figure A.7: Result of quantization procedure.

1. We decide on the length that the ratios of the tuplet refer to. We shall choose an eighth-note ($TUP_r = 8$) (this would mean that the ratio 3:2 would refer to 3 *eighth-notes* in the space of 2 *eighth-notes*).
2. Calculate the tuplet numerator.

$$TUP_n = l \times p \times \frac{TUP_r}{4} = 1.5 \times 3 \times \frac{8}{4} = 9$$

3. Calculate the numerator of the time signature. We will choose the time signature denominator to be 4 ($TS_d = 4$).

$$TS^n = \frac{TS_d}{TUP_r} \times TUP_d = \frac{4}{8} \times 4 = 2$$

4. This will give us the notation seen in Figure A.7.

Our Syntax: x Pulses y Second(s) Apart

The equations above were used to generate the work *Our Syntax: x Pulses y Second(s) Apart*, using the following variables:

Fixed variables:

- $i = 1$
- $p = 3$

Permutated Variables:

- $l = \{0.25, 0.5, 0.75, 1.0, 1.5, 1.75, 2.0\}$
- $TUP_d = \{2, 3, 4, 5, 6, 7, 9\}$
- $TUP_r = \{4, 8, 16\}$
- $TS_d = \{4, 8, 16\}$

Outputs were only used when they meet all of the following criteria:
 $30 < tempo < 150$, $n_{TUP} \in \mathbb{Z}$, and $n_{SIG} \in \mathbb{Z}$.

Appendix B

Code For Generating All Possible Structures

Ruby code for generating all possible structures and morphological vectors within a given range:

```
# Ruby
class FormMaker
  def initialize (int_ext)
    #this initialization takes one argument: Whether the output is to the ruby window
    # or to a separate .txt file named using the current date and time.
    # 'ruby' = ruby window, 'file' = file
    @int_ext = int_ext
    @alpha = Hash[(1..26).to_a].zip('A'..'Z').to_a
    @numberer = Hash[('A'..'Z').to_a].zip((0..25).to_a)
  end

  def time_filename (affix, filetype)
    #this function creates a filename with the current date and time
    # and outputs a filename consisting of:
    # date-time-affix.filetype e.g. 2017-04-16_12-15_testfile.ly
    time = Time.now
    timesplit = time.to_s.split(" ")
    clock = timesplit[1].split(":")
    @filename = "#{timesplit[0]}_#{clock[0]}-#{clock[1]}_#{@affix}.#{@filetype}"
    @f = File.new(@filename, "w")
  end

  def primer (primearray)
    # this converts an array of subarrays (primearray) into a string of letters and prime marks
    # into a letter with x prime marks afterwards e.g primer('A',3) = A'''
    stringout = ""
    primearray.each do |lettouts, numouts|
      stringout << lettouts + (''' * numouts) + " "
    end
    return "#{stringout}"
  end

  def outputter (outter)
    #This takes in a string and outputs it either to a file or the ruby console
    if @int_ext == "ruby"
      puts outter
    else
      @f.puts outter
    end
  end

  def generator (sections, mat_type)
    # this def takes 2 initialization values, taken from the onscreen prompts:
    # the number of sections the piece has, and the number of material types.
    @sections = sections
    @mat_type = mat_type

    @letters = []
    (1..@mat_type).to_a.each{|x| @letters.push(@alpha[x])}
    @primes = []
    for x in (0...@letters.length)
      for i in (0...(@sections-x)) do
        # @primes is an array consisting of sub-arrays:
        # [Form letter, Number of prime marks]
        # e.g. [A,3] = A'''
        @primes.push([@letters[x], i])
      end
    end
    outputter("#{@sections} Sections #{@mat_type} Materials")
    outputter("Material Types: #{@primer(@primes)}")
  end

  def vectorizer (vectin)
    # This generates the morphological vector
    if vectin.length > 1
      hashvect = vectin.uniq
      mapper = Hash[hashvect.sort.zip(0...hashvect.length)]
      vect_out = []
      for i in (0...(vectin.length-1))
        vect_out.push(mapper[vectin[i+1]] - mapper[vectin[i]])
      end
    end
  end
end
```

```

        end
    else
        vectout = " "
    end
    return "#{vect_out}"
end

def permeff
    #This is a less computationally expensive way of generating the combinations
    #than
    if @sections < 3
        @perms = @primes.repeated_permutation(@sections).to_a
    else
        bpl = [] #big permutation list
        for il in (0...(@sections-1))
            permlist = []
            @primes.each do |prilet, prinum|
                if prinum <= (il + 1) && (@numberer[prilet]+prinum) <= (il + 1)
                    permlist.push([prilet, prinum])
                end
            end
            bpl.push(permlist)
        end
        @perms = bpl[0].product(*bpl[1..-1])
        @perms.each {|ooo| ooo.unshift(["A", 0])}
    end
end

def permutations (vnum, vo)
    #calculates permutations. The one variable is whether vectors are printed ('v') or not ('w')
    if @mat_type <= @sections
        permeff
        counter = 0
        @perms.each do |z|
            # checker is the starting value for a series of tests
            # if the tests show the permutation (z) is unsuitable, checker will be changed
            # to 0.
            # if permutation z passes all the tests it will be printed.
            @checker = 1
            if z.first != ["A", 0]
                @checker = 0
            else
                @letters.each do |w|
                    numorder = []
                    z.each do |lett, num|
                        if lett == w; numorder.push(num); end
                    end
                    jumpchecker(numorder)
                end
                lettorder = []
                z.each{ |lett, num| lettorder.push(@numberer[lett])}
                if lettorder.uniq.length != @mat_type
                    @checker = 0
                else
                    jumpchecker(lettorder)
                end
            end
        end
        if @checker == 1
            counter += 1
            if vnum == "y" && vo == "v"
                outputter("#{counter}: #{primer(z)} #{vectorizer(z)}")
            elsif vnum == "y" && vo == "w"
                outputter("#{counter}: #{primer(z)}")
            elsif vnum == "n" && vo == "v"
                outputter("#{primer(z)} #{vectorizer(z)}")
            else
                outputter("#{primer(z)}")
            end
        end
    end
    counter = 0
end

outputter("#{@sections} sections with #{@mat_type} material types gives #{counter} possible
forms.")
outputter("----")
outputter(" ")

end

def jumpchecker (inarray)
    if inarray.length > 0
        jumpcheck = -1
        inarray.each do |inner|
            if inner > (jumpcheck+1)
                @checker = 0
            elsif inner > jumpcheck
                jumpcheck = inner
            end
        end
    end
end

def filehandler
    if @int_ext == "file"
        @f.close
        puts "Wrote #{@filename}"
    end
end

end

puts "This code calculates the amount of possible forms and their morphological vectors"
puts "given a number of sections and a number of material types."
puts "Do you want the results of this to be: "
puts "- written to a file in the same directory as this code (type 1),"
puts "- or the output displayed in this window (type 0)"
inty = gets.chomp.to_i
if inty == 0

```



```

        filey = "ruby"
    else
        filey = "file"
    end
    puts "Should it print forms with vectors (type v) or without (type w)"
    vonoff = gets.chomp

    puts "Should it number the forms? Type y for yes, type n for no."
    numfo = gets.chomp

    puts "Do you want to select the Sections and Material Types (type s),"
    puts "or calculate combinatorically all possibilities between 1 and 5? (type c)"
    sm = gets.chomp

    if sm == "s"
        puts "WARNING: Don't go above 6 sections With 6 material types,"
        puts "the possibilities become too large!"
        puts "How Many Sections Does The Work Have?"
        questsect = gets.chomp.to_i
        puts "How Many Material Types Are Used In The Work?"
        mat = gets.chomp.to_i
        sectmat = [[questsect, mat]]
    else
        sectmat = [1,2,3,4,5].repeated_permutation(2).to_a
    end

    form = FormMaker.new(filey)
    form.time_filename("allforms", "txt")
    sectmat.each do |matty|
        form.generator(matty[0], matty[1])
        form.permutations(numfo, vonoff)
    end
    form.filehandler
end

```

Appendix C

Completist Structures

Form Consisting of 1 Section

1 Sections 1 Materials:

Material Types: A A'

$$1: \left| A \mid [\emptyset] \right|$$

Form Consisting of 2 Sections

2 Sections 1 Materials:

Material Types: A A'

$$1: \left| A A \mid \begin{array}{l} [0] \\ [1] \end{array} \right|$$

2 Sections 2 Materials:

Material Types: A A' B

$$1: \left| A B \mid [1] \right|$$

Form Consisting of 3 Sections

3 Sections 1 Materials:

Material Types: A A' A''

$$\begin{array}{l} 1: \left| A A A \mid \begin{array}{l} [0, 0] \\ [0, 1] \end{array} \right| \\ 2: \left| A A A' \mid \begin{array}{l} [0, 1] \\ [1, -1] \end{array} \right| \\ 3: \left| A A' A \mid \begin{array}{l} [1, 0] \\ [1, 1] \end{array} \right| \\ 4: \left| A A' A' \mid \begin{array}{l} [1, 0] \\ [1, 1] \end{array} \right| \\ 5: \left| A A' A'' \mid \begin{array}{l} [1, 0] \\ [1, 1] \end{array} \right| \end{array}$$

3 Sections 2 Materials:

Material Types: A A' A'' B B'

$$\begin{array}{l} 1: \left| A A B \mid \begin{array}{l} [0, 1] \\ [1, 1] \end{array} \right| \\ 2: \left| A A' B \mid \begin{array}{l} [1, 1] \\ [1, -1] \end{array} \right| \\ 3: \left| A B A \mid \begin{array}{l} [1, -1] \\ [2, -1] \end{array} \right| \\ 4: \left| A B A' \mid \begin{array}{l} [2, -1] \\ [1, 0] \end{array} \right| \\ 5: \left| A B B \mid \begin{array}{l} [1, 0] \\ [1, 1] \end{array} \right| \\ 6: \left| A B B' \mid \begin{array}{l} [1, 1] \end{array} \right| \end{array}$$

3 Sections 3 Materials:

Material Types: A A' A'' B B' C

$$1: \left| A B C \mid [1, 1] \right|$$

Form Consisting of 4 Sections

4 Sections 1 Materials:

Material Types: A A' A'' A'''

$$\begin{array}{l} 1: \left| A A A A \mid \begin{array}{l} [0, 0, 0] \\ [0, 0, 1] \end{array} \right| \\ 2: \left| A A A A' \mid \begin{array}{l} [0, 1, -1] \\ [0, 1, 0] \end{array} \right| \\ 3: \left| A A A' A \mid \begin{array}{l} [0, 1, 0] \\ [0, 1, 1] \end{array} \right| \\ 4: \left| A A A' A' \mid \begin{array}{l} [0, 1, 1] \\ [1, -1, 0] \end{array} \right| \\ 5: \left| A A A' A'' \mid \begin{array}{l} [1, -1, 0] \\ [1, -1, 1] \end{array} \right| \\ 6: \left| A A' A A \mid \begin{array}{l} [1, -1, 1] \\ [1, -1, 2] \end{array} \right| \\ 7: \left| A A' A A' \mid \begin{array}{l} [1, 0, -1] \\ [1, 0, 0] \end{array} \right| \\ 8: \left| A A' A A'' \mid \begin{array}{l} [1, 0, 0] \\ [1, 0, 1] \end{array} \right| \\ 9: \left| A A' A' A \mid \begin{array}{l} [1, 0, 1] \\ [1, 1, -2] \end{array} \right| \\ 10: \left| A A' A' A' \mid \begin{array}{l} [1, 1, -1] \\ [1, 1, 0] \end{array} \right| \\ 11: \left| A A' A' A'' \mid \begin{array}{l} [1, 1, 0] \\ [1, 1, 1] \end{array} \right| \\ 12: \left| A A' A'' A \mid \begin{array}{l} [1, 1, 0] \\ [1, 1, 1] \end{array} \right| \\ 13: \left| A A' A'' A' \mid \begin{array}{l} [1, 1, 0] \\ [1, 1, 1] \end{array} \right| \\ 14: \left| A A' A'' A'' \mid \begin{array}{l} [1, 1, 0] \\ [1, 1, 1] \end{array} \right| \\ 15: \left| A A' A'' A''' \mid \begin{array}{l} [1, 1, 1] \end{array} \right| \end{array}$$

4 Sections 2 Materials:

Material Types: A A' A'' A''' B B' B''

1:	A A A B	[0, 0, 1]
2:	A A A' B	[0, 1, 1]
3:	A A B A	[0, 1, -1]
4:	A A B A'	[0, 2, -1]
5:	A A B B	[0, 1, 0]
6:	A A B B'	[0, 1, 1]
7:	A A' A B	[1, -1, 2]
8:	A A' A' B	[1, 0, 1]
9:	A A' A'' B	[1, 1, 1]
10:	A A' B A	[1, 1, -2]
11:	A A' B A'	[1, 1, -1]
12:	A A' B A''	[1, 2, -1]
13:	A A' B B	[1, 1, 0]
14:	A A' B B'	[1, 1, 1]
15:	A B A A	[1, -1, 0]
16:	A B A A'	[2, -2, 1]
17:	A B A B	[1, -1, 1]
18:	A B A B'	[1, -1, 2]
19:	A B A' A	[2, -1, -1]
20:	A B A' A'	[2, -1, 0]
21:	A B A' A''	[3, -2, 1]
22:	A B A' B	[2, -1, 1]
23:	A B A' B'	[2, -1, 2]
24:	A B B A	[1, 0, -1]
25:	A B B A'	[2, 0, -1]
26:	A B B B	[1, 0, 0]
27:	A B B B'	[1, 0, 1]
28:	A B B' A	[1, 1, -2]
29:	A B B' A'	[2, 1, -2]
30:	A B B' B	[1, 1, -1]
31:	A B B' B'	[1, 1, 0]
32:	A B B' B''	[1, 1, 1]

4 Sections 3 Materials:

Material Types: A A' A'' A''' B B' B'' C C'

1:	A A B C	[0, 1, 1]
2:	A A' B C	[1, 1, 1]
3:	A B A C	[1, -1, 2]
4:	A B A' C	[2, -1, 2]
5:	A B B C	[1, 0, 1]
6:	A B B' C	[1, 1, 1]
7:	A B C A	[1, 1, -2]
8:	A B C A'	[2, 1, -2]
9:	A B C B	[1, 1, -1]
10:	A B C B'	[1, 2, -1]
11:	A B C C	[1, 1, 0]
12:	A B C C'	[1, 1, 1]

4 Sections 4 Materials:

Material Types: A A' A'' A''' B B' B'' C C' D

1:	A B C D	[1, 1, 1]
----	---------	-----------

Form Consisting of 5 Sections

5 Sections 1 Materials:

Material Types: A A' A'' A''' A''''

1:	A A A A A	[0, 0, 0, 0]
2:	A A A A A'	[0, 0, 0, 1]
3:	A A A A' A	[0, 0, 1, -1]
4:	A A A A' A'	[0, 0, 1, 0]
5:	A A A A' A''	[0, 0, 1, 1]
6:	A A A' A A	[0, 1, -1, 0]
7:	A A A' A A'	[0, 1, -1, 1]
8:	A A A' A A''	[0, 1, -1, 2]
9:	A A A' A' A	[0, 1, 0, -1]
10:	A A A' A' A'	[0, 1, 0, 0]
11:	A A A' A' A''	[0, 1, 0, 1]
12:	A A A' A'' A	[0, 1, 1, -2]
13:	A A A' A'' A'	[0, 1, 1, -1]
14:	A A A' A'' A''	[0, 1, 1, 0]
15:	A A A' A'' A'''	[0, 1, 1, 1]
16:	A A' A A A	[1, -1, 0, 0]
17:	A A' A A A'	[1, -1, 0, 1]
18:	A A' A A A''	[1, -1, 0, 2]
19:	A A' A A' A	[1, -1, 1, -1]
20:	A A' A A' A'	[1, -1, 1, 0]
21:	A A' A A' A''	[1, -1, 1, 1]
22:	A A' A A'' A	[1, -1, 2, -2]
23:	A A' A A'' A'	[1, -1, 2, -1]
24:	A A' A A'' A''	[1, -1, 2, 0]
25:	A A' A A'' A'''	[1, -1, 2, 1]
26:	A A' A' A A	[1, 0, -1, 0]
27:	A A' A' A A'	[1, 0, -1, 1]
28:	A A' A' A A''	[1, 0, -1, 2]
29:	A A' A' A' A	[1, 0, 0, -1]
30:	A A' A' A' A'	[1, 0, 0, 0]
31:	A A' A' A' A''	[1, 0, 0, 1]
32:	A A' A' A'' A	[1, 0, 1, -2]
33:	A A' A' A'' A'	[1, 0, 1, -1]
34:	A A' A' A'' A''	[1, 0, 1, 0]
35:	A A' A' A'' A'''	[1, 0, 1, 1]
36:	A A' A'' A A	[1, 1, -2, 0]
37:	A A' A'' A A'	[1, 1, -2, 1]
38:	A A' A'' A A''	[1, 1, -2, 2]
39:	A A' A'' A A'''	[1, 1, -2, 3]
40:	A A' A'' A' A	[1, 1, -1, -1]
41:	A A' A'' A' A'	[1, 1, -1, 0]
42:	A A' A'' A' A''	[1, 1, -1, 1]
43:	A A' A'' A' A'''	[1, 1, -1, 2]
44:	A A' A'' A'' A	[1, 1, 0, -2]
45:	A A' A'' A'' A'	[1, 1, 0, -1]
46:	A A' A'' A'' A''	[1, 1, 0, 0]
47:	A A' A'' A'' A'''	[1, 1, 0, 1]
48:	A A' A'' A''' A	[1, 1, 1, -3]
49:	A A' A'' A''' A'	[1, 1, 1, -2]
50:	A A' A'' A''' A''	[1, 1, 1, -1]
51:	A A' A'' A''' A'''	[1, 1, 1, 0]
52:	A A' A'' A'''' A'''	[1, 1, 1, 1]

5 Sections 2 Materials:

Material Types: A A' A'' A''' A'''' B B' B'' B'''

1:	A A A A B	[0, 0, 0, 1]
2:	A A A A' B	[0, 0, 1, 1]
3:	A A A B A	[0, 0, 1, -1]
4:	A A A B A'	[0, 0, 2, -1]
5:	A A A B B	[0, 0, 1, 0]
6:	A A A B B'	[0, 0, 1, 1]
7:	A A A' A B	[0, 1, -1, 2]
8:	A A A' A' B	[0, 1, 0, 1]
9:	A A A' A'' B	[0, 1, 1, 1]
10:	A A A' B A	[0, 1, 1, -2]
11:	A A A' B A'	[0, 1, 1, -1]
12:	A A A' B A''	[0, 1, 2, -1]
13:	A A A' B B	[0, 1, 1, 0]
14:	A A A' B B'	[0, 1, 1, 1]
15:	A A B A A	[0, 1, -1, 0]
16:	A A B A A'	[0, 2, -2, 1]
17:	A A B A B	[0, 1, -1, 1]
18:	A A B A B'	[0, 1, -1, 2]
19:	A A B A' A	[0, 2, -1, -1]
20:	A A B A' A'	[0, 2, -1, 0]
21:	A A B A' A''	[0, 3, -2, 1]
22:	A A B A' B	[0, 2, -1, 1]
23:	A A B A' B'	[0, 2, -1, 2]
24:	A A B B A	[0, 1, 0, -1]
25:	A A B B A'	[0, 2, 0, -1]
26:	A A B B B	[0, 1, 0, 0]
27:	A A B B B'	[0, 1, 0, 1]
28:	A A B B' A	[0, 1, 1, -2]
29:	A A B B' A'	[0, 2, 1, -2]
30:	A A B B' B	[0, 1, 1, -1]
31:	A A B B' B'	[0, 1, 1, 0]
32:	A A B B' B''	[0, 1, 1, 1]
33:	A A' A A B	[1, -1, 0, 2]
34:	A A' A A' B	[1, -1, 1, 1]
35:	A A' A A'' B	[1, -1, 2, 1]
36:	A A' A B A	[1, -1, 2, -2]
37:	A A' A B A'	[1, -1, 2, -1]
38:	A A' A B A''	[1, -1, 3, -1]
39:	A A' A B B	[1, -1, 2, 0]
40:	A A' A B B'	[1, -1, 2, 1]
41:	A A' A' A B	[1, 0, -1, 2]
42:	A A' A' A' B	[1, 0, 0, 1]
43:	A A' A' A'' B	[1, 0, 1, 1]
44:	A A' A' B A	[1, 0, 1, -2]
45:	A A' A' B A'	[1, 0, 1, -1]
46:	A A' A' B A''	[1, 0, 2, -1]
47:	A A' A' B B	[1, 0, 1, 0]
48:	A A' A' B B'	[1, 0, 1, 1]
49:	A A' A'' A B	[1, 1, -2, 3]
50:	A A' A'' A' B	[1, 1, -1, 2]
51:	A A' A'' A'' B	[1, 1, 0, 1]
52:	A A' A'' A''' B	[1, 1, 1, 1]
53:	A A' A'' B A	[1, 1, 1, -3]
54:	A A' A'' B A'	[1, 1, 1, -2]
55:	A A' A'' B A''	[1, 1, 1, -1]
56:	A A' A'' B A'''	[1, 1, 2, -1]
57:	A A' A'' B B	[1, 1, 1, 0]
58:	A A' A'' B B'	[1, 1, 1, 1]
59:	A A' B A A	[1, 1, -2, 0]
60:	A A' B A A'	[1, 1, -2, 1]
61:	A A' B A A''	[1, 2, -3, 2]
62:	A A' B A B	[1, 1, -2, 2]
63:	A A' B A B'	[1, 1, -2, 3]
64:	A A' B A' A	[1, 1, -1, -1]
65:	A A' B A' A'	[1, 1, -1, 0]
66:	A A' B A' A''	[1, 2, -2, 1]
67:	A A' B A' B	[1, 1, -1, 1]
68:	A A' B A' B'	[1, 1, -1, 2]
69:	A A' B A'' A	[1, 2, -1, -2]
70:	A A' B A'' A'	[1, 2, -1, -1]
71:	A A' B A'' A''	[1, 2, -1, 0]
72:	A A' B A'' A'''	[1, 3, -2, 1]
73:	A A' B A'' B	[1, 2, -1, 1]
74:	A A' B A'' B'	[1, 2, -1, 2]
75:	A A' B B A	[1, 1, 0, -2]
76:	A A' B B A'	[1, 1, 0, -1]
77:	A A' B B A''	[1, 2, 0, -1]
78:	A A' B B B	[1, 1, 0, 0]
79:	A A' B B B'	[1, 1, 0, 1]
80:	A A' B B' A	[1, 1, 1, -3]
81:	A A' B B' A'	[1, 1, 1, -2]
82:	A A' B B' A''	[1, 2, 1, -2]
83:	A A' B B' B	[1, 1, 1, -1]
84:	A A' B B' B'	[1, 1, 1, 0]
85:	A A' B B' B''	[1, 1, 1, 1]
86:	A B A A A	[1, -1, 0, 0]
87:	A B A A A'	[2, -2, 0, 1]
88:	A B A A B	[1, -1, 0, 1]
89:	A B A A B'	[1, -1, 0, 2]
90:	A B A A' A	[2, -2, 1, -1]
91:	A B A A' A'	[2, -2, 1, 0]
92:	A B A A' A''	[3, -3, 1, 1]
93:	A B A A' B	[2, -2, 1, 1]
94:	A B A A' B'	[2, -2, 1, 2]
95:	A B A B A	[1, -1, 1, -1]
96:	A B A B A'	[2, -2, 2, -1]
97:	A B A B B	[1, -1, 1, 0]
98:	A B A B B'	[1, -1, 1, 1]
99:	A B A B' A	[1, -1, 2, -2]
100:	A B A B' A'	[2, -2, 3, -2]
101:	A B A B' B	[1, -1, 2, -1]
102:	A B A B' B'	[1, -1, 2, 0]
103:	A B A B' B''	[1, -1, 2, 1]
104:	A B A' A A	[2, -1, -1, 0]
105:	A B A' A A'	[2, -1, -1, 1]
106:	A B A' A A''	[3, -2, -1, 2]
107:	A B A' A B	[2, -1, -1, 2]
108:	A B A' A B'	[2, -1, -1, 3]
109:	A B A' A' A	[2, -1, 0, -1]
110:	A B A' A' A'	[2, -1, 0, 0]
111:	A B A' A' A''	[3, -2, 0, 1]
112:	A B A' A' B	[2, -1, 0, 1]
113:	A B A' A' B'	[2, -1, 0, 2]
114:	A B A' A'' A	[3, -2, 1, -2]
115:	A B A' A'' A'	[3, -2, 1, -1]
116:	A B A' A'' A''	[3, -2, 1, 0]
117:	A B A' A'' A'''	[4, -3, 1, 1]
118:	A B A' A'' B	[3, -2, 1, 1]
119:	A B A' A'' B'	[3, -2, 1, 2]
120:	A B A' B A	[2, -1, 1, -2]
121:	A B A' B A'	[2, -1, 1, -1]
122:	A B A' B A''	[3, -2, 2, -1]
123:	A B A' B B	[2, -1, 1, 0]
124:	A B A' B B'	[2, -1, 1, 1]
125:	A B A' B' A	[2, -1, 2, -3]
126:	A B A' B' A'	[2, -1, 2, -2]
127:	A B A' B' A''	[3, -2, 3, -2]
128:	A B A' B' B	[2, -1, 2, -1]
129:	A B A' B' B'	[2, -1, 2, 0]
130:	A B A' B' B''	[2, -1, 2, 1]
131:	A B B A A	[1, 0, -1, 0]
132:	A B B A A'	[2, 0, -2, 1]

133:	A B B A B	[1, 0, -1, 1]
134:	A B B A B'	[1, 0, -1, 2]
135:	A B B A' A	[2, 0, -1, -1]
136:	A B B A' A'	[2, 0, -1, 0]
137:	A B B A' A''	[3, 0, -2, 1]
138:	A B B A' B	[2, 0, -1, 1]
139:	A B B A' B'	[2, 0, -1, 2]
140:	A B B B A	[1, 0, 0, -1]
141:	A B B B A'	[2, 0, 0, -1]
142:	A B B B B	[1, 0, 0, 0]
143:	A B B B B'	[1, 0, 0, 1]
144:	A B B B' A	[1, 0, 1, -2]
145:	A B B B' A'	[2, 0, 1, -2]
146:	A B B B' B	[1, 0, 1, -1]
147:	A B B B' B'	[1, 0, 1, 0]
148:	A B B B' B''	[1, 0, 1, 1]
149:	A B B' A A	[1, 1, -2, 0]
150:	A B B' A A'	[2, 1, -3, 1]
151:	A B B' A B	[1, 1, -2, 1]
152:	A B B' A B'	[1, 1, -2, 2]
153:	A B B' A B''	[1, 1, -2, 3]
154:	A B B' A' A	[2, 1, -2, -1]
155:	A B B' A' A'	[2, 1, -2, 0]
156:	A B B' A' A''	[3, 1, -3, 1]
157:	A B B' A' B	[2, 1, -2, 1]
158:	A B B' A' B'	[2, 1, -2, 2]
159:	A B B' A' B''	[2, 1, -2, 3]
160:	A B B' B A	[1, 1, -1, -1]
161:	A B B' B A'	[2, 1, -1, -1]
162:	A B B' B B	[1, 1, -1, 0]
163:	A B B' B B'	[1, 1, -1, 1]
164:	A B B' B B''	[1, 1, -1, 2]
165:	A B B' B' A	[1, 1, 0, -2]
166:	A B B' B' A'	[2, 1, 0, -2]
167:	A B B' B' B	[1, 1, 0, -1]
168:	A B B' B' B'	[1, 1, 0, 0]
169:	A B B' B' B''	[1, 1, 0, 1]
170:	A B B' B'' A	[1, 1, 1, -3]
171:	A B B' B'' A'	[2, 1, 1, -3]
172:	A B B' B'' B	[1, 1, 1, -2]
173:	A B B' B'' B'	[1, 1, 1, -1]
174:	A B B' B'' B''	[1, 1, 1, 0]
175:	A B B' B'' B'''	[1, 1, 1, 1]

5 Sections 3 Materials:

Material Types: A A' A'' A''' A'''' B B' B'' B''' C
C' C''

1:	A A A B C	[0, 0, 1, 1]
2:	A A A' B C	[0, 1, 1, 1]
3:	A A B A C	[0, 1, -1, 2]
4:	A A B A' C	[0, 2, -1, 2]
5:	A A B B C	[0, 1, 0, 1]
6:	A A B B' C	[0, 1, 1, 1]
7:	A A B C A	[0, 1, 1, -2]
8:	A A B C A'	[0, 2, 1, -2]
9:	A A B C B	[0, 1, 1, -1]
10:	A A B C B'	[0, 1, 2, -1]
11:	A A B C C	[0, 1, 1, 0]
12:	A A B C C'	[0, 1, 1, 1]
13:	A A' A B C	[1, -1, 2, 1]
14:	A A' A' B C	[1, 0, 1, 1]
15:	A A' A'' B C	[1, 1, 1, 1]
16:	A A' B A C	[1, 1, -2, 3]
17:	A A' B A' C	[1, 1, -1, 2]
18:	A A' B A'' C	[1, 2, -1, 2]
19:	A A' B B C	[1, 1, 0, 1]
20:	A A' B B' C	[1, 1, 1, 1]
21:	A A' B C A	[1, 1, 1, -3]
22:	A A' B C A'	[1, 1, 1, -2]
23:	A A' B C A''	[1, 2, 1, -2]
24:	A A' B C B	[1, 1, 1, -1]
25:	A A' B C B'	[1, 1, 2, -1]
26:	A A' B C C	[1, 1, 1, 0]
27:	A A' B C C'	[1, 1, 1, 1]
28:	A B A A C	[1, -1, 0, 2]
29:	A B A A' C	[2, -2, 1, 2]
30:	A B A B C	[1, -1, 1, 1]
31:	A B A B' C	[1, -1, 2, 1]
32:	A B A C A	[1, -1, 2, -2]
33:	A B A C A'	[2, -2, 3, -2]
34:	A B A C B	[1, -1, 2, -1]
35:	A B A C B'	[1, -1, 3, -1]
36:	A B A C C	[1, -1, 2, 0]
37:	A B A C C'	[1, -1, 2, 1]
38:	A B A' A C	[2, -1, -1, 3]
39:	A B A' A' C	[2, -1, 0, 2]
40:	A B A' A'' C	[3, -2, 1, 2]
41:	A B A' B C	[2, -1, 1, 1]
42:	A B A' B' C	[2, -1, 2, 1]
43:	A B A' C A	[2, -1, 2, -3]
44:	A B A' C A'	[2, -1, 2, -2]
45:	A B A' C A''	[3, -2, 3, -2]
46:	A B A' C B	[2, -1, 2, -1]
47:	A B A' C B'	[2, -1, 3, -1]
48:	A B A' C C	[2, -1, 2, 0]
49:	A B A' C C'	[2, -1, 2, 1]
50:	A B B A C	[1, 0, -1, 2]
51:	A B B A' C	[2, 0, -1, 2]
52:	A B B B C	[1, 0, 0, 1]
53:	A B B B' C	[1, 0, 1, 1]
54:	A B B C A	[1, 0, 1, -2]
55:	A B B C A'	[2, 0, 1, -2]
56:	A B B C B	[1, 0, 1, -1]
57:	A B B C B'	[1, 0, 2, -1]
58:	A B B C C	[1, 0, 1, 0]
59:	A B B C C'	[1, 0, 1, 1]
60:	A B B' A C	[1, 1, -2, 3]

61:	A B B' A' C	[2, 1, -2, 3]
62:	A B B' B C	[1, 1, -1, 2]
63:	A B B' B' C	[1, 1, 0, 1]
64:	A B B' B'' C	[1, 1, 1, 1]
65:	A B B' C A	[1, 1, 1, -3]
66:	A B B' C A'	[2, 1, 1, -3]
67:	A B B' C B	[1, 1, 1, -2]
68:	A B B' C B'	[1, 1, 1, -1]
69:	A B B' C B''	[1, 1, 2, -1]
70:	A B B' C C	[1, 1, 1, 0]
71:	A B B' C C'	[1, 1, 1, 1]
72:	A B C A A	[1, 1, -2, 0]
73:	A B C A A'	[2, 1, -3, 1]
74:	A B C A B	[1, 1, -2, 1]
75:	A B C A B'	[1, 2, -3, 2]
76:	A B C A C	[1, 1, -2, 2]
77:	A B C A C'	[1, 1, -2, 3]
78:	A B C A' A	[2, 1, -2, -1]
79:	A B C A' A'	[2, 1, -2, 0]
80:	A B C A' A''	[3, 1, -3, 1]
81:	A B C A' B	[2, 1, -2, 1]
82:	A B C A' B'	[2, 2, -3, 2]
83:	A B C A' C	[2, 1, -2, 2]
84:	A B C A' C'	[2, 1, -2, 3]
85:	A B C B A	[1, 1, -1, -1]
86:	A B C B A'	[2, 1, -1, -1]
87:	A B C B B	[1, 1, -1, 0]
88:	A B C B B'	[1, 2, -2, 1]
89:	A B C B C	[1, 1, -1, 1]
90:	A B C B C'	[1, 1, -1, 2]
91:	A B C B' A	[1, 2, -1, -2]
92:	A B C B' A'	[2, 2, -1, -2]
93:	A B C B' B	[1, 2, -1, -1]
94:	A B C B' B'	[1, 2, -1, 0]
95:	A B C B' B''	[1, 3, -2, 1]
96:	A B C B' C	[1, 2, -1, 1]
97:	A B C B' C'	[1, 2, -1, 2]
98:	A B C C A	[1, 1, 0, -2]
99:	A B C C A'	[2, 1, 0, -2]
100:	A B C C B	[1, 1, 0, -1]
101:	A B C C B'	[1, 2, 0, -1]
102:	A B C C C	[1, 1, 0, 0]
103:	A B C C C'	[1, 1, 0, 1]
104:	A B C C' A	[1, 1, 1, -3]
105:	A B C C' A'	[2, 1, 1, -3]
106:	A B C C' B	[1, 1, 1, -2]
107:	A B C C' B'	[1, 2, 1, -2]
108:	A B C C' C	[1, 1, 1, -1]
109:	A B C C' C'	[1, 1, 1, 0]
110:	A B C C' C''	[1, 1, 1, 1]

5 Sections 4 Materials:

Material Types: A A' A'' A''' A'''' B B' B'' B''' C
C' C'' D D'

1:	A A B C D	[0, 1, 1, 1]
2:	A A' B C D	[1, 1, 1, 1]
3:	A B A C D	[1, -1, 2, 1]
4:	A B A' C D	[2, -1, 2, 1]
5:	A B B C D	[1, 0, 1, 1]
6:	A B B' C D	[1, 1, 1, 1]
7:	A B C A D	[1, 1, -2, 3]
8:	A B C A' D	[2, 1, -2, 3]
9:	A B C B D	[1, 1, -1, 2]
10:	A B C B' D	[1, 2, -1, 2]
11:	A B C C D	[1, 1, 0, 1]
12:	A B C C' D	[1, 1, 1, 1]
13:	A B C D A	[1, 1, 1, -3]
14:	A B C D A'	[2, 1, 1, -3]
15:	A B C D B	[1, 1, 1, -2]
16:	A B C D B'	[1, 2, 1, -2]
17:	A B C D C	[1, 1, 1, -1]
18:	A B C D C'	[1, 1, 2, -1]
19:	A B C D D	[1, 1, 1, 0]
20:	A B C D D'	[1, 1, 1, 1]

5 Sections 5 Materials:

Material Types: A A' A'' A''' A'''' B B' B'' B''' C
C' C'' D D' E

1:	A B C D E	[1, 1, 1, 1]
----	-----------	--------------

Appendix D

List of Possible Morphological Vectors

Sections	2			
Materials	1	1	2	all
	[0]	[0] [1]	[1]	[0] [1]
TOTAL	1	2	1	2

Table D.1: All possible morphological vectors with 1 or 2 sections.

Sections	3			
Materials	1	2	3	all
	[0, 0] [0, 1] [1, -1] [1, 1] [2, 0]	[0, 1] [1, -1] [1, 1] [2, -1] [2, 0]	[1, 1]	[0, 0] [0, 1] [1, -1] [1, 1] [2, -1] [2, 0]
TOTAL	5	5	1	6

Table D.2: All possible morphological vectors with 3 sections.

Sections	4				
Materials	1	2	3	4	all
	[0, 0, 0]	[0, 0, 1]	[0, 1, 1]	[1, 1, 1]	[0, 0, 0]
	[0, 0, 1]	[0, 1, -1]	[1, -1, 2]		[0, 0, 1]
	[0, 1, -1]	[0, 1, 1]	[1, 1, -2]		[0, 1, -1]
	[0, 1, 1]	[0, 2, -1]	[1, 1, 1]		[0, 1, 1]
	[0, 2, 0]	[0, 2, 0]	[1, 2, -1]		[0, 2, -1]
	[1, -1, 0]	[1, -1, 0]	[1, 2, 0]		[0, 2, 0]
	[1, -1, 2]	[1, -1, 2]	[2, -1, 2]		[1, -1, 0]
	[1, 1, -2]	[1, 1, -2]	[2, 0, 1]		[1, -1, 2]
	[1, 1, 1]	[1, 1, 1]	[2, 1, -1]		[1, 1, -2]
	[1, 2, 0]	[1, 2, -1]	[2, 1, -2]		[1, 1, 1]
	[2, -2, 2]	[1, 2, 0]			[1, 2, -1]
	[2, 0, -2]	[2, -1, -1]			[1, 2, 0]
	[2, 0, 1]	[2, -1, 2]			[2, -1, -1]
	[2, 1, -1]	[2, -2, 1]			[2, -1, 2]
	[3, 0, 0]	[2, -2, 2]			[2, -2, 1]
		[2, 0, -2]			[2, -2, 2]
		[2, 0, 1]			[2, 0, -2]
		[2, 1, -1]			[2, 0, 1]
		[2, 1, -2]			[2, 1, -1]
		[3, -1, 0]			[2, 1, -2]
		[3, -2, 1]			[3, -1, 0]
		[3, -2, 2]			[3, -2, 1]
		[3, 0, -2]			[3, -2, 2]
		[3, 0, 0]			[3, 0, -2]
					[3, 0, 0]
TOTAL	15	24	10	1	25

Table D.3: All possible morphological vectors with 4 sections.

Sections	5					
Materials	1	2	3	4	5	all
	[0, 0, 0, 0]	[0, 0, 0, 1]	[0, 0, 1, 1]	[0, 1, 1, 1]	[1, 1, 1, 1]	[0, 0, 0, 0]
	[0, 0, 0, 1]	[0, 0, 1, -1]	[0, 1, -1, 2]	[1, -1, 2, 1]		[0, 0, 0, 1]
	[0, 0, 1, -1]	[0, 0, 1, 1]	[0, 1, 1, -2]	[1, 1, -2, 3]		[0, 0, 1, -1]
	[0, 0, 1, 1]	[0, 0, 2, -1]	[0, 1, 1, 1]	[1, 1, 1, -3]		[0, 0, 1, 1]
	[0, 0, 2, 0]	[0, 0, 2, 0]	[0, 1, 2, -1]	[1, 1, 1, 1]		[0, 0, 2, -1]
	[0, 1, -1, 0]	[0, 1, -1, 0]	[0, 1, 2, 0]	[1, 1, 2, -1]		[0, 0, 2, 0]
	[0, 1, -1, 2]	[0, 1, -1, 2]	[0, 2, -1, 2]	[1, 1, 2, 0]		[0, 1, -1, 0]
	[0, 1, 1, -2]	[0, 1, 1, -2]	[0, 2, 0, 1]	[1, 2, -1, 2]		[0, 1, -1, 2]
	[0, 1, 1, 1]	[0, 1, 1, 1]	[0, 2, 1, -1]	[1, 2, 0, 1]		[0, 1, 1, -2]
	[0, 1, 2, 0]	[0, 1, 2, -1]	[0, 2, 1, -2]	[1, 2, 1, -1]		[0, 1, 1, 1]
	[0, 2, -2, 2]	[0, 1, 2, 0]	[1, -1, 0, 2]	[1, 2, 1, -2]		[0, 1, 2, -1]
	[0, 2, 0, -2]	[0, 2, -1, -1]	[1, -1, 2, -2]	[2, -1, 2, 1]		[0, 1, 2, 0]
	[0, 2, 0, 1]	[0, 2, -1, 2]	[1, -1, 2, 1]	[2, 0, 1, 1]		[0, 2, -1, -1]
	[0, 2, 1, -1]	[0, 2, -2, 1]	[1, -1, 3, -1]	[2, 1, -1, 2]		[0, 2, -1, 2]
	[0, 3, 0, 0]	[0, 2, -2, 2]	[1, -1, 3, 0]	[2, 1, -2, 3]		[0, 2, -2, 1]
	[1, -1, 0, 0]	[0, 2, 0, -2]	[1, 1, -2, 0]	[2, 1, 1, -2]		[0, 2, -2, 2]
	[1, -1, 0, 2]	[0, 2, 0, 1]	[1, 1, -2, 3]	[2, 1, 1, -3]		[0, 2, 0, -2]
	[1, -1, 2, -2]	[0, 2, 1, -1]	[1, 1, 1, -3]			[0, 2, 0, 1]
	[1, -1, 2, 1]	[0, 2, 1, -2]	[1, 1, 1, 1]			[0, 2, 1, -1]
	[1, -1, 3, 0]	[0, 3, -1, 0]	[1, 1, 2, -1]			[0, 2, 1, -2]
	[1, 1, -2, 0]	[0, 3, -2, 1]	[1, 1, 2, 0]			[0, 3, -1, 0]
	[1, 1, -2, 3]	[0, 3, -2, 2]	[1, 2, -1, -2]			[0, 3, -2, 1]
	[1, 1, 1, -3]	[0, 3, 0, -2]	[1, 2, -1, 2]			[0, 3, -2, 2]
	[1, 1, 1, 1]	[0, 3, 0, 0]	[1, 2, -3, 2]			[0, 3, 0, -2]
	[1, 1, 2, 0]	[1, -1, 0, 0]	[1, 2, -3, 3]			[0, 3, 0, 0]
	[1, 2, -3, 3]	[1, -1, 0, 2]	[1, 2, 0, -3]			[1, -1, 0, 0]
	[1, 2, 0, -3]	[1, -1, 2, -2]	[1, 2, 0, 1]			[1, -1, 0, 2]
	[1, 2, 0, 1]	[1, -1, 2, 1]	[1, 2, 1, -1]			[1, -1, 2, -2]
	[1, 2, 1, -1]	[1, -1, 3, -1]	[1, 2, 1, -2]			[1, -1, 2, 1]
	[1, 3, 0, 0]	[1, -1, 3, 0]	[1, 3, -1, 0]			[1, -1, 3, -1]
	[2, -2, 0, 2]	[1, 1, -2, 0]	[1, 3, -2, 1]			[1, -1, 3, 0]
	[2, -2, 2, -2]	[1, 1, -2, 3]	[1, 3, -2, 2]			[1, 1, -2, 0]
	[2, -2, 2, 1]	[1, 1, 1, -3]	[1, 3, 0, -2]			[1, 1, -2, 3]
	[2, -2, 3, -1]	[1, 1, 1, 1]	[1, 3, 0, 0]			[1, 1, 1, -3]
	[2, 0, -2, 0]	[1, 1, 2, -1]	[1, 3, -1, 3]			[1, 1, 1, 1]
	[2, 0, -2, 3]	[1, 1, 2, 0]	[2, -1, 2, -3]			[1, 1, 2, -1]

[2, 0, 1, -3]
 [2, 0, 1, 1]
 [2, 0, 2, 0]
 [2, 1, -1, -2]
 [2, 1, -1, 2]
 [2, 1, -3, 2]
 [2, 1, 1, -2]
 [2, 2, -2, 2]
 [2, 2, 0, -2]
 [3, -3, 3, 0]
 [3, 0, -3, 3]
 [3, 0, 0, -3]
 [3, 0, 0, 1]
 [3, 0, 1, -1]
 [3, 1, -1, 0]
 [4, 0, 0, 0]

[1, 2, -1, -2]
 [1, 2, -1, 2]
 [1, 2, -3, 2]
 [1, 2, -3, 3]
 [1, 2, 0, -3]
 [1, 2, 0, 1]
 [1, 2, 1, -1]
 [1, 2, 1, -2]
 [1, 3, -1, 0]
 [1, 3, -2, 1]
 [1, 3, -2, 2]
 [1, 3, 0, -2]
 [1, 3, 0, 0]
 [2, -1, -1, 0]
 [2, -1, -1, 3]
 [2, -1, 2, -3]
 [2, -1, 2, 1]
 [2, -1, 3, 0]
 [2, -2, 0, 1]
 [2, -2, 0, 2]
 [2, -2, 1, -1]
 [2, -2, 1, 2]
 [2, -2, 2, -2]
 [2, -2, 2, 1]
 [2, -2, 3, -1]
 [2, -2, 3, -2]
 [2, 0, -2, 0]
 [2, 0, -2, 3]
 [2, 0, 1, -3]
 [2, 0, 1, 1]
 [2, 0, 2, -1]
 [2, 0, 2, 0]
 [2, 1, -1, -2]
 [2, 1, -1, 2]
 [2, 1, -2, -1]
 [2, 1, -2, 3]
 [2, 1, -3, 1]
 [2, 1, -3, 2]
 [2, 1, 1, -2]
 [2, 1, 1, -3]
 [2, 2, -1, -1]
 [2, 2, -2, 1]
 [2, 2, -2, 2]
 [2, 2, -3, 3]
 [2, 2, 0, -2]
 [2, 2, 0, -3]
 [3, -1, -2, 2]
 [3, -1, 0, -2]
 [3, -1, 0, 2]
 [3, -1, 2, -2]
 [3, -2, -1, 2]
 [3, -2, -1, 3]
 [3, -2, 1, -2]
 [3, -2, 1, 2]
 [3, -2, 2, -3]
 [3, -2, 2, 1]
 [3, -2, 3, -1]
 [3, -2, 3, -2]
 [3, -3, 1, 1]
 [3, -3, 1, 2]
 [3, -3, 2, 0]
 [3, -3, 3, -2]
 [3, -3, 3, 0]
 [3, 0, -2, -1]
 [3, 0, -2, 3]
 [3, 0, -3, 1]
 [3, 0, -3, 3]
 [3, 0, 0, -3]
 [3, 0, 0, 1]
 [3, 0, 1, -1]
 [3, 0, 1, -3]

[2, -1, 2, 1]
 [2, -1, 3, -1]
 [2, -1, 3, 0]
 [2, -2, 1, 2]
 [2, -2, 2, 1]
 [2, -2, 3, -1]
 [2, -2, 3, -2]
 [2, 0, -2, 3]
 [2, 0, 1, -3]
 [2, 0, 1, 1]
 [2, 0, 2, -1]
 [2, 0, 2, 0]
 [2, 1, -1, -2]
 [2, 1, -1, 2]
 [2, 1, -2, -1]
 [2, 1, -2, 3]
 [2, 1, -3, 1]
 [2, 1, -3, 2]
 [2, 1, 1, -2]
 [2, 2, -1, -1]
 [2, 2, -1, -2]
 [2, 2, -2, 1]
 [2, 2, -2, 2]
 [2, 2, -3, 2]
 [2, 2, -3, 3]
 [2, 2, 0, -2]
 [2, 2, 0, -3]
 [3, -1, 0, 2]
 [3, -1, 2, -2]
 [3, -2, 1, 2]
 [3, -2, 2, 1]
 [3, -2, 3, -1]
 [3, -2, 3, -2]
 [3, 0, -2, 3]
 [3, 0, 0, 1]
 [3, 0, 1, -1]
 [3, 0, 1, -3]
 [3, 1, -1, -2]
 [3, 1, -1, 0]
 [3, 1, -2, 0]
 [3, 1, -3, 1]
 [3, 1, -3, 2]

[1, 1, 2, 0]
 [1, 2, -1, -2]
 [1, 2, -1, 2]
 [1, 2, -3, 2]
 [1, 2, -3, 3]
 [1, 2, 0, -3]
 [1, 2, 0, 1]
 [1, 2, 1, -1]
 [1, 2, 1, -2]
 [1, 3, -1, 0]
 [1, 3, -2, 1]
 [1, 3, -2, 2]
 [1, 3, 0, -2]
 [1, 3, 0, 0]
 [2, -1, -1, 0]
 [2, -1, -1, 3]
 [2, -1, 2, -3]
 [2, -1, 2, 1]
 [2, -1, 3, -1]
 [2, -1, 3, 0]
 [2, -2, 0, 1]
 [2, -2, 0, 2]
 [2, -2, 1, -1]
 [2, -2, 1, 2]
 [2, -2, 2, -2]
 [2, -2, 2, 1]
 [2, -2, 3, -1]
 [2, -2, 3, -2]
 [2, 0, -2, 0]
 [2, 0, -2, 3]
 [2, 0, 1, -3]
 [2, 0, 1, 1]
 [2, 0, 2, -1]
 [2, 0, 2, 0]
 [2, 1, -1, -2]
 [2, 1, -1, 2]
 [2, 1, -2, -1]
 [2, 1, -2, 3]
 [2, 1, -3, 1]
 [2, 1, -3, 2]
 [2, 1, 1, -2]
 [2, 1, 1, -3]
 [2, 2, -1, -1]
 [2, 2, -1, -2]
 [2, 2, -2, 1]
 [2, 2, -2, 2]
 [2, 2, -3, 2]
 [2, 2, -3, 3]
 [2, 2, 0, -2]
 [2, 2, 0, -3]
 [3, -1, -2, 2]
 [3, -1, 0, -2]
 [3, -1, 2, -2]
 [3, -2, -1, 2]
 [3, -2, -1, 3]
 [3, -2, 1, -2]
 [3, -2, 1, 2]
 [3, -2, 2, -3]
 [3, -2, 2, 1]
 [3, -2, 3, -1]
 [3, -2, 3, -2]
 [3, -3, 1, 1]
 [3, -3, 1, 2]
 [3, -3, 2, 0]
 [3, -3, 3, -2]
 [3, -3, 3, 0]
 [3, 0, -2, -1]
 [3, 0, -2, 3]
 [3, 0, -3, 1]
 [3, 0, -3, 3]

		[3, 1, -1, -2] [3, 1, -1, 0] [3, 1, -2, 0] [3, 1, -3, 1] [3, 1, -3, 2] [4, -1, 0, 0] [4, -2, 0, 1] [4, -2, 0, 2] [4, -2, 1, -1] [4, -2, 2, -2] [4, -3, 1, 1] [4, -3, 1, 2] [4, -3, 2, 0] [4, -3, 3, -2] [4, -3, 3, 0] [4, 0, -2, 0] [4, 0, -3, 1] [4, 0, -3, 3] [4, 0, 0, -3] [4, 0, 0, 0]				[3, 0, 0, -3] [3, 0, 0, 1] [3, 0, 1, -1] [3, 0, 1, -3] [3, 1, -1, -2] [3, 1, -1, 0] [3, 1, -2, 0] [3, 1, -3, 1] [3, 1, -3, 2] [4, -1, 0, 0] [4, -2, 0, 1] [4, -2, 0, 2] [4, -2, 1, -1] [4, -2, 2, -2] [4, -3, 1, 1] [4, -3, 1, 2] [4, -3, 2, 0] [4, -3, 3, -2] [4, -3, 3, 0] [4, 0, -2, 0] [4, 0, -3, 1] [4, 0, -3, 3] [4, 0, 0, -3] [4, 0, 0, 0]
TOTAL	52	127	79	17	1	131

Appendix E

Analysis Of Footnote

An analysis of the footnote from the first page of Chapter 1 of this thesis. The way I have broken down the footnote is such that not all of the clauses are "true" clauses, in the grammatical sense, but each division aims to aid the composition process used in the Conclusion. Each of the numbered red boxes indicate how the clause has been divided up. The amount of these parts of the clause used in each section of the Conclusion can be found in Table 5.4 - lower-numbered components are removed first.

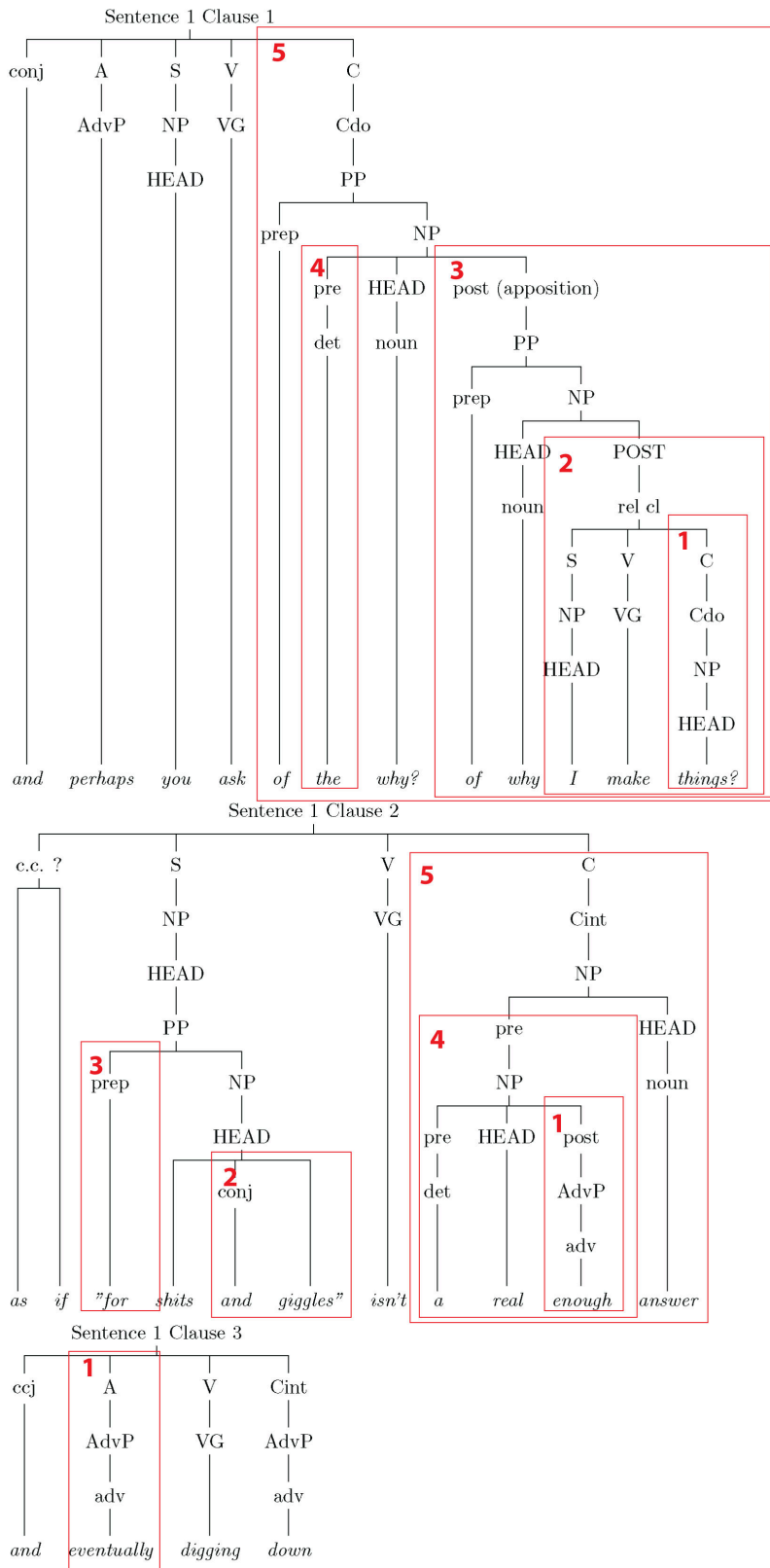

Figure E.1: Analysis of footnote from the first page of Chapter 1 split into component parts indicated by the numbered red boxes.

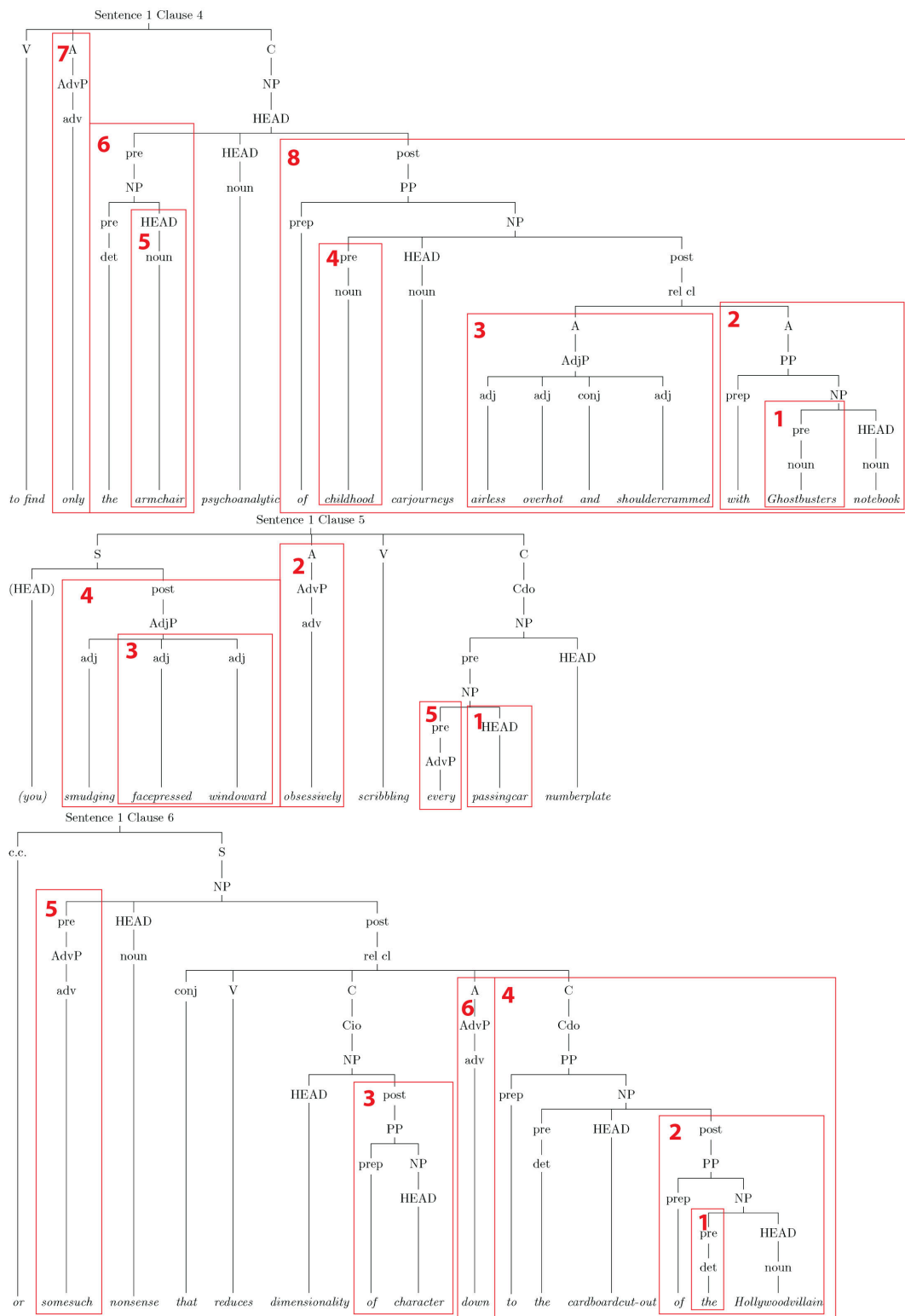

Figure E.2: Analysis of footnote from the first page of Chapter 1.

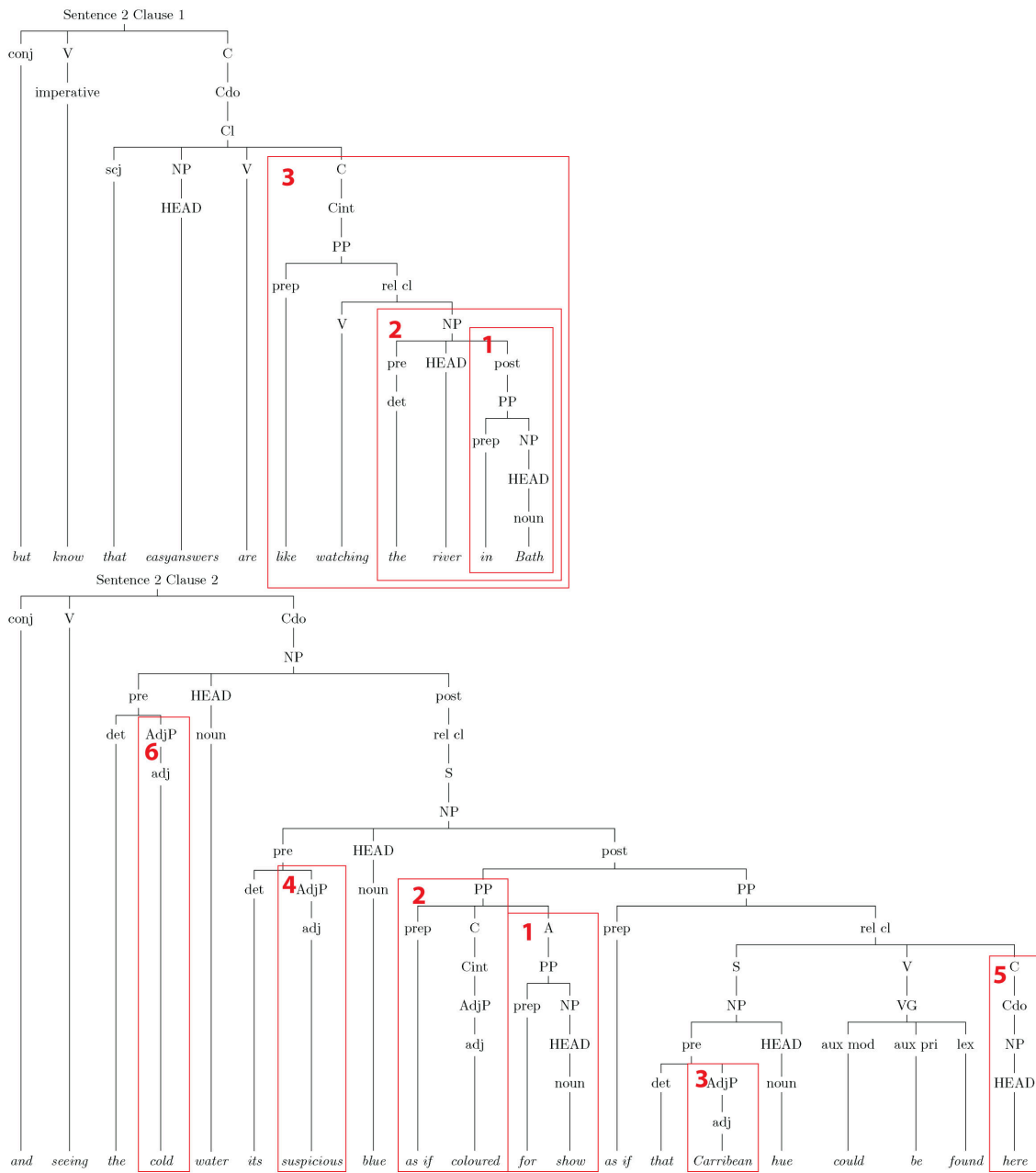

Figure E.3: Analysis of footnote from the first page of Chapter 1.

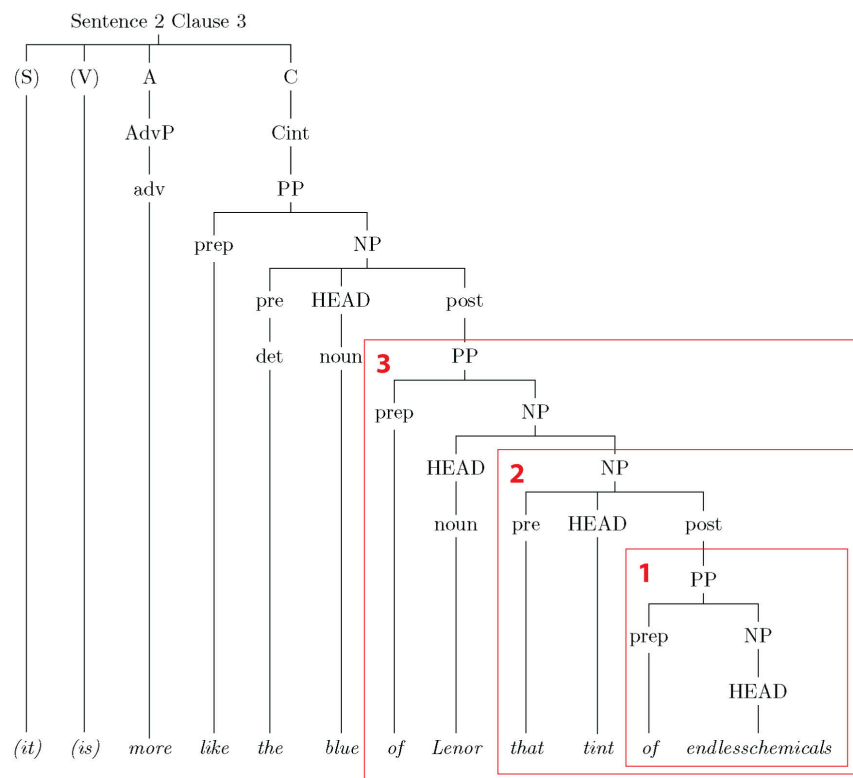

Figure E.4: Analysis of footnote from the first page of Chapter 1.

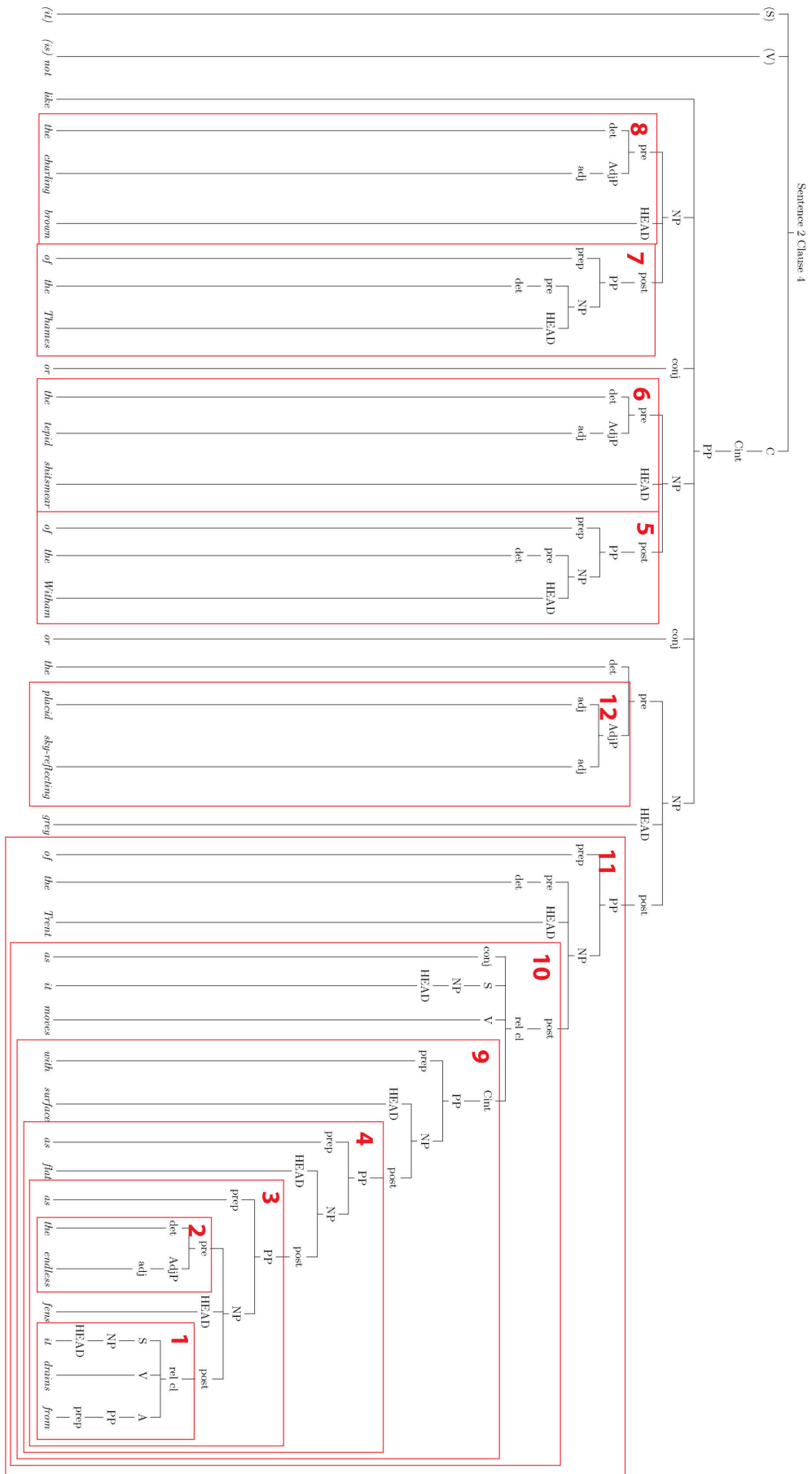

Figure E.5: Analysis of footnote 314 from the first page of Chapter 1.

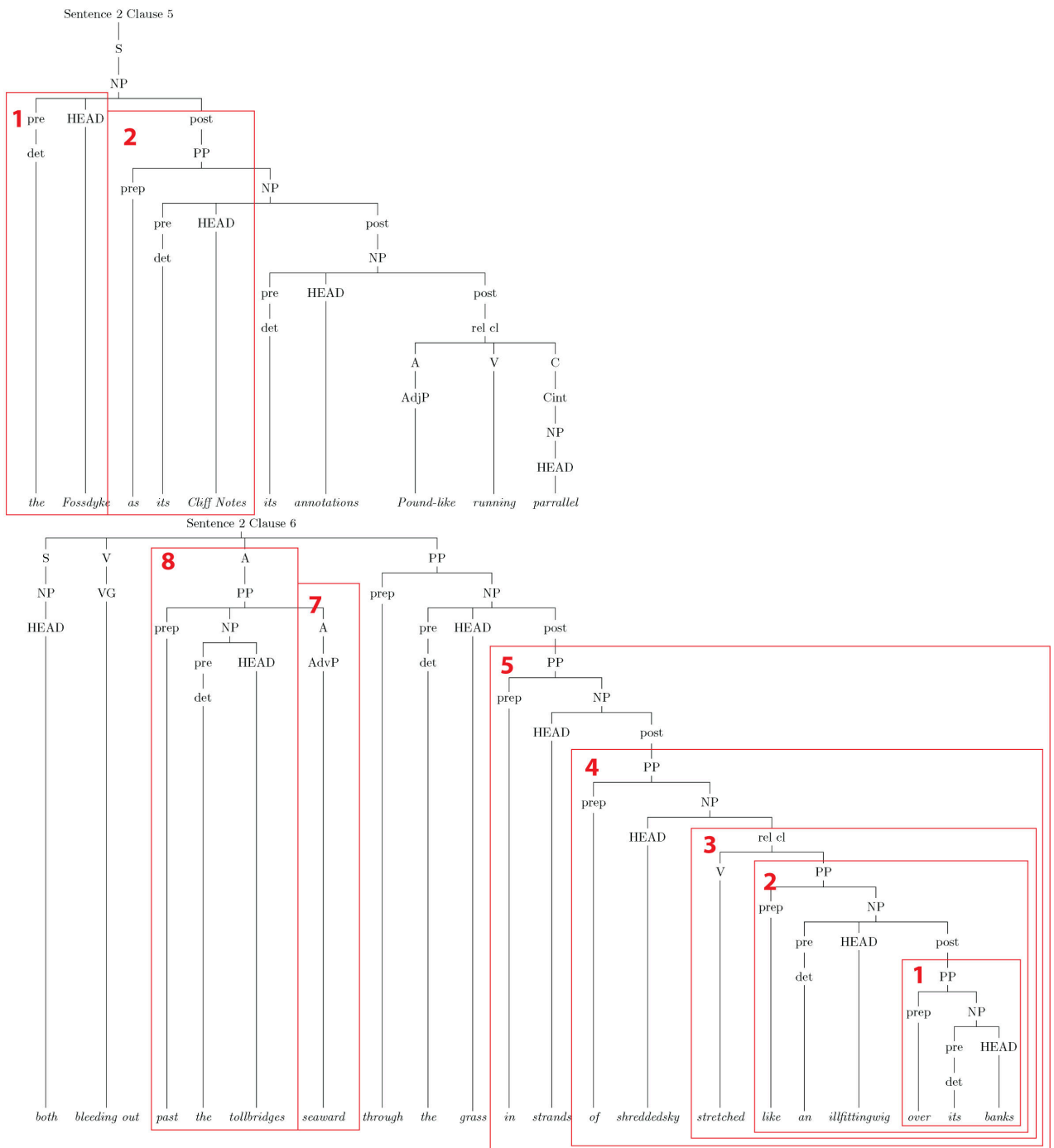

Figure E.6: Analysis of footnote from the first page of Chapter 1.

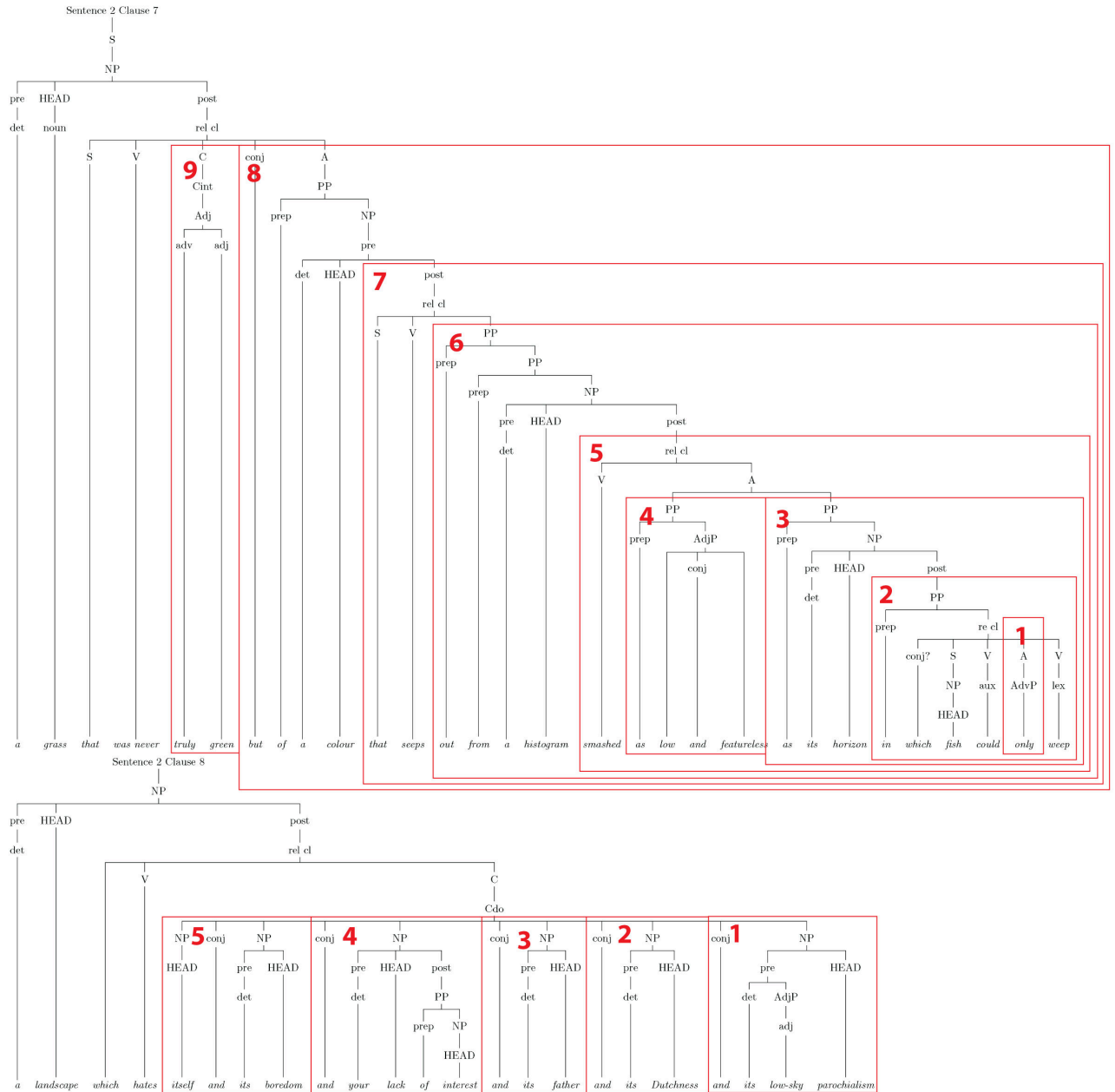

Figure E.7: Analysis of footnote from the first page of Chapter 1

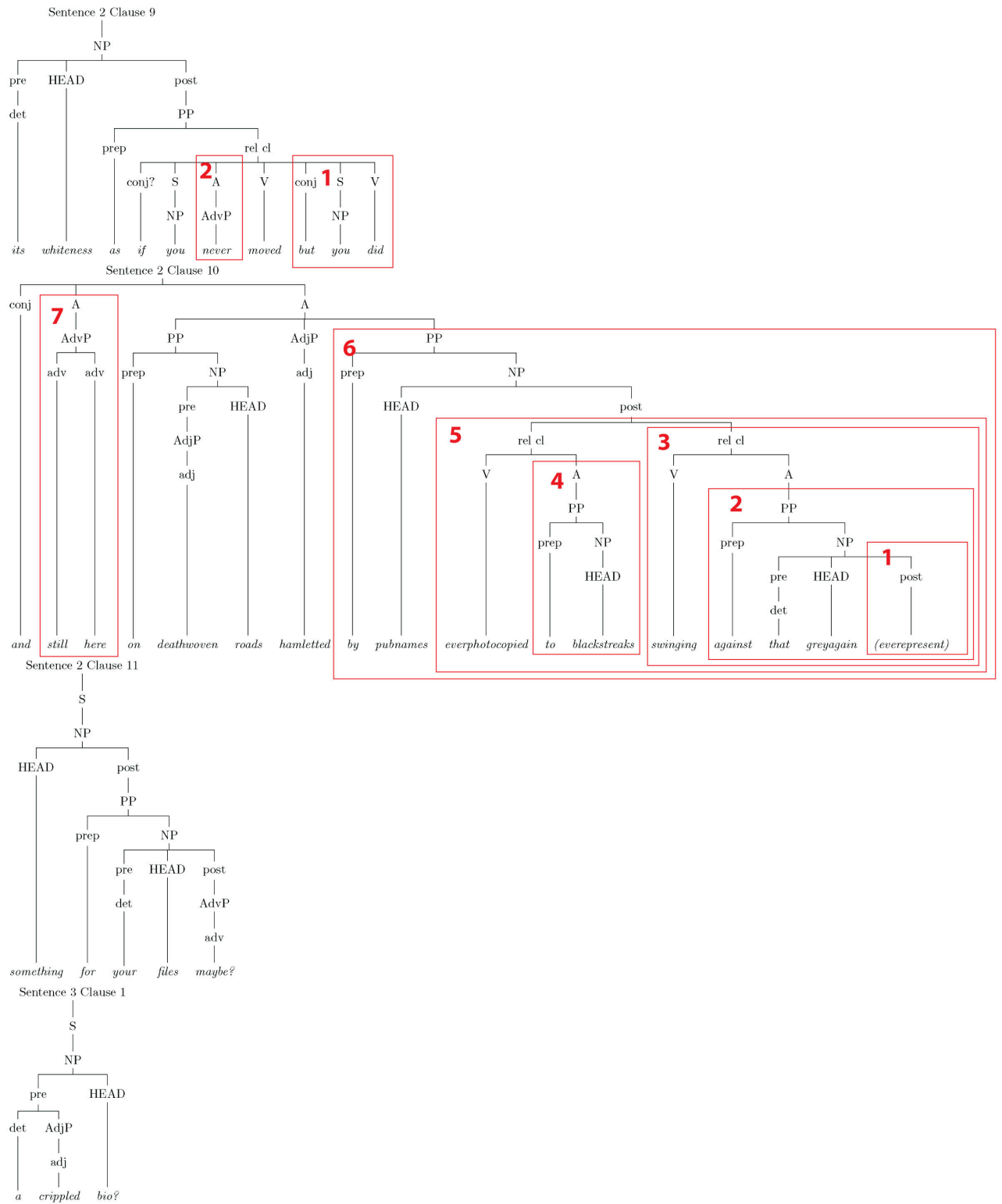

Figure E.8: Analysis of footnote from the first page of Chapter 1